

Maintenance manuals

How to use this manual

This manual describes the maintenance procedures of ZF500F.

Sections 1 and 3 apply to the entire motorcycle. Section 2 explains the procedures for removing/installing components that may be used to perform the services described in the following sections.

Sections 4 to 21 describe the parts of the motorcycle, grouped by location.

If you are not familiar with this motorcycle, please read the technical characteristics in section 1.

Follow the recommendations of the maintenance schedule (Section 3) to ensure that the motorcycle is in the best running condition, in accordance with the relevant regulations of the European Union (EU) No.168/2013, in line with (EU) No.134/2014 and (EU) Regulation No.2018/295 requires it. It compensates for the initial wear that occurs during the running-in period. Find the part you want on this page, and then go to the catalog on the first page of the part.

Most parts start with assembly or system instructions, maintenance information, and troubleshooting.

The following pages give a detailed process. According to the fault or symptom, refer to the troubleshooting of each part.

Your and others' safety are very important. To help you make an informed decision, we provide safety information and other information in this manual.

You must use your good judgment.

You will find various forms of important safety information, including safety labels on the vehicle,

Safety message - preceded by a safety alert symbol  and one of three signal words, DANGER,

WARNING, or CAUTION. These signal words mean:

 **DANGER** : You will be killed or seriously hurt if you don' t follow this section.











 **WARNING** : You can be killed or seriously hurt if you don' t follow this section.

 **CAUTION** : You can be hurt if you don' t follow this section.

Instructions - how to service this vehicle correctly and safely.

Symbols

The symbols used in this manual show specific maintenance procedures. If supplementary information is required pertaining to this symbols, it would be explained specifically in the text without the use of the symbols.

	Replace parts with new parts before assembly
	Use the recommended oil, unless otherwise specified.
	Use molybdenum oil solution (mixture of the engine oil and molybdenum grease in a ratio of 1:1).
	Use multipurpose grease (lithium base multipurpose grease NLGI #2 or equivalent).
	Use molybdenum disulphide grease (containing more than 3% molybdenum disulphide, NLGI #2 or equivalent). Example: Molykote br-2 plus manufactured by Dow Corning U. S. A Multi-purpose M-2 manufactured by Mitsubishi Oil, Japan
	Use molybdenum disulfide paste (containing more than 40% molybdenum disulfide, NLGI #2 or equivalent). For example: G-n slurry produced by Dow Corning
	Using silicone grease
	Apply locking agent. Use a medium strength locking agent unless otherwise specified.
	Applied sealant
	Use DOT4 brand fluid. Use the recommended brake fluid unless otherwise specified.
	Use fork or suspension fluid

CONTENTS

GENERAL INFORMATION-----	1
FRAME/BODY PANEL/EXHAUST SYSTEM -----	2
MAINTENANCE -----	3
E F I S Y S T E M -----	4
IGNITION SYSTEM -----	5
ELECTRIC STARTER -----	6
FUEL SYSTEM -----	7
COLING SYSTEM -----	8
LUBRICATION SYSTEM -----	9
CYLINDER HEAD/VALVES -----	10
CLUTCH/GEARSHIFT LINKAGE -----	11
ALTERNATOR/STARTER CLUCH -----	12
CRANKCASE/TRANSMISSION -----	13
CRANKSHAFT/PISTON/CYLINDER/BALANCER -----	14
ENGINE REMOVAL/INSTALLATION -----	15
FRONT WHEEL/SUSPENSION/STEERING -----	16
REAR WHEEL/SUSPENSION -----	17
HYDRAULIC BRAKE -----	18
ANTIL-LOCK BRAKE SYSTEM (ABS) -----	19
BATTERY/CHARGING SYSTEM -----	20
LIGHTS/METERS/SWITCH -----	21
WIRING DIAGAMS -----	21

1. GENERAL INFORMATION

SERVICE RULES ----- 1-1

MODEL IDENTIFICATION ----- 1-2

SPECIFICATIONS ----- 1-3

TORQUE VALUES ----- 1-11

LUBRICATION/SEALPOINTS ----- 1-15

EMISSION CONTROL SYSTEMS ----- 1-18

SERVICE RULES

1. Use Colove or Colove recommended parts and lubricants or their equivalents. Parts that do not meet Colove's design specifications may cause damage to the motorcycle.
2. Use special tools designed for this product to avoid damage and incorrect assembly.
3. Only metric tools can be used when repairing motorcycles. Metric bolts, nuts and screws cannot be interchanged with inch fasteners.
4. Use new gaskets, O-rings, split pins and lock plates when reassembling.
5. When tightening bolts or nuts, first start with large diameter or inner bolts. Then tighten to the specified torque in diagonal increments, unless a specific order is specified.
6. Clean the parts with detergent when disassembling. Lubricate all sliding surfaces before reassembling.
7. After reassembly, check whether all parts are installed and operated correctly.
8. Route all wires as shown in the cable and cable duct routing.
9. Do not bend or twist the control cable. The damaged control cable cannot work normally and may get stuck or twisted.

ABBREVIATION

Throughout this manual, the following abbreviations are used to identify the respective parts or systems.

缩写词	全称
ABS	Anti-lock Braking System
CKP sensor	Crankshaft Position Sensor
DLC	Data Link Connector
DTC	Diagnosis Trouble code
ECU	Engine Control Module
ECT sensor	Engine Coolant Temperature Sensor
EEPROM	Electrically Erasable Programmable Read Only Memory
EOP switch	Engine Oil Pressure Switch
EVAP	Evaporative Emission
IAT sensor	Intake Air temperature Sensor
MAP sensor	Manifold Absolute Pressure Sensor
MCS	Motorcycle Communication System
MIL	Malfunction Indicator Lamp
O ₂ sensor	Oxygen Sensor
SCS Service connector	Service Check Short Service connector
TP sensor	Throttle Position Sensor
VS sensor	Vehicle Speed Sensor

MODEL IDENTIFICATION



GENERAL INFORMATION

General specification: ZF500F

ITEM		SPECIFICATION		
DIMENSION	Overall length	STR: 2156mm (84.9 in); SCR: 2168mm (85.4 in)		
	Overall width	850 mm (33.5 in)		
	Overall height	STR: 1177mm (46.3 in); SCR: 1200mm (47.2 in)		
	Wheelbase	1460mm (57.5 in)		
	No load seat height	STR: 785 mm (30.9in); SCR: 825 (32.4in)		
	No load pedal height	STR: 280 mm (11.0in); SCR: 320 (12.6in)		
	Ground clearance without load	STR: 180mm; SCR: 210mm		
	Dry weight	STR: 190kg (419lbs); SCR: 182kg (400lbs); City edition: 182kg (400lbs)		
	Maximum allowable load on front axle	123kg(270lbs)		
	Maximum allowable load on rear axle	220kg(482lbs)		
	Maximum weight capacity	STR: 560kg (1234lbs); City edition: 551kg (1214lbs); SCR: 554kg (1221lbs);		
FRAME	Frame type	Diamond shape,dual-wing beam		
	Front suspension	Telescopic fork		
	Front axle travel	STR: 148mm; SCR: 189.5mm		
	Rear suspension	Rear fork		
	Rear axle travel	STR: 158mm; SCR: 190mm		
	Front tire size	STR: 110/80R18; City edition: 110/80-18; SCR: 110/80R19		
	Rear tire size	STR: 160/60R17; City edition: 160/60-17; SCR: 150/70R17		
	Front tire brand	Pirelli and TIMSUN		
	Rear tire brand	Pirelli and TIMSUN		
	Front tire brake	Hydraulic single disc		
	Rear tire brake	Hydraulic single disc		
	Caster angle	25°30'		
	Trail length	105mm (4.1in)		
	Fuel tank capacity	18L (4.7US gal, 3.9 Imp gal)		
ENGINE	Cylinder arrangement	Left: 1, Right: 2; 19°		
	Cylinder diameter and stroke	67.000-67.015		
	Displacement	471ml		
	Compression ratio	10.7:1		
	Distribution agency	Double overhead convex shaft four valve chain drive		
	Intake valve	-5°BTDC	at1mm(0.04 in)lift	-5°BTDC
		35°ABDC	at1mm(0.04 in)lift	35°ABDC
	Exhaust valve	33°BBDC	at1mm(0.04 in)lift	33°BBDC
		-13°ATDC	at1mm(0.04 in)lift	-13°ATDC
	Lubrication system	Forced pressure lubrication and Splash lubrication		
	Oil pump type	Cycloidal		
	Cooling system	Water cooling		
	Air filter	Paper filter		
	Engine weight	52.7kg(116.2lbs)		
Firing order	FTI 1-2			
Number of cylinders	Left 1; Right 2			

GENERAL INFORMATION

ITEM		SPECIFICATION	
Fuel supply system	Type	Bosch efi	
	Throttle hole	34mm(1.3in)	
Transmission system	Clutch system	Multi-plate,wet	
	Clutch operating system	Cable operating	
	Transmission	Constant engagement, 6 speed	
	Primary reduction	2.029 (69/34)	
	Final reduction	SCR: 2.933 (44/15) STR: 2.8 (42/15)	
	Gear ratio	1th	3.285(46/14)
		2nd	2.105(40/19)
		3rd	1.600(32/20)
4th		1.300(26/20)	
5th		1.150(23/20)	
6th		1.043(24/23)	
Gearshift pattern		Left foot operated return system1-N-2-3-4-5-6	
ELECTRICAL	Ignition system	Full transistorized ignition	
	Starting system	Electric starter motor	
	Charging system	Tripe phase output alternator	
	Regulator/rectifier	Tripe phase full wave rectification	
	Lighting system	Battery	

Efi System Specifications

ITEM	SPECIFICATION
Engine idle speed (High/low)	1350±100rpm
ECT Sensor resistance (40°C/104°F)	1.0-1.3kΩ
IAT Sensor resistance (20°C/68°F)	1-4kΩ
Fuel injector resistance (20°C/68°F)	11-13Ω
O ₂ Sensor heater resistance (20°C/68°F)	10-40Ω
IACV resistance (25°C/77°F)	110-150Ω

Ignition System Specifications

ITEM	SPECIFICATION
Spark plug	CPR8EA-9 (NGK)
Spark plug gap	0.80-0.90mm (0.031-0.035in)
Ignition coil peak voltage	100V minimum
CKP sensor peak voltage	0.7V minimum
Ignition timing ("F"mark)	Idle ignition angle is adjusted by PID closed loop, the adjustment range is between 0-8 (°CA) BTDC (before top dead center)

Electric Starter Specifications

Unit: mm (in)

ITEM	STANDARD	SERVICE LIMIT
Starter motor brush length	12.0-13.0 (0.47-0.51)	6.5 (0.26)

Fuel System Specifications

ITEM		SPECIFICATION
Throttle body identification number		
Throttle grip freelay		10-20mm (0.4-0.8in)
Fuel pressure at idle		343kpa (3.5kaf/cm ² , 50psi)
Fuel pump flow (12V, 300kpa)		≥15L/h
PAIR control solenoid valve resistance(20°C/68°F)		30-34Ω

Cooling System Specifications

ITEM		SPECIFICATION
Cooling capacity	Radiator and engine	1.4 L (1.5 US qt, 1.2 Imp qt)
	Water tank	0.12 L (0.13 US qt, 0.11 Imp qt)
The radiator cap relief pressure		108-137 kPa (1.1-1.4 kaf/cm ² , 16-20 psi)
Thermostat	Begin to open	82±2°C (176-183°F)
	Fully open	95°C (203°F)
	Valve lift	Not less than 8 mm (0.3 in) mini
Recommended antifreeze		Ethanol contains no silicate coolant (Dongfeng castrol lec-ii-25)
Standard coolant concentration		1:1 mixture with distilled water

Lubrication system specification

Unit: mm(in)

ITEM		STANDARD	SERVICE LIMIT
Engine oil capacity	After the oil change	2.5L(2.6US pt,2.2Imp qt)	-
	After removing the oil filter	2.7L(2.9US pt,2.4Imp qt)	-
	After engine disassembly	2.9L(3.2US pt,2.8Imp qt)	
Recommended engine oil		API service category :SG or higher (except for round API service label that indicates energy saving oil)JASO T903 standard :MA viscosity :SAE 10w40	-
Oil pressure at EOP switch		Pressure at 1200 RPM /80°C:93 kPa (0.9 kgf/cm ² , 13 psi)	-
Oil pump rotor	Tip clearance	0.15 (0.006)	0.20 (0.008)
	Body clearance	0.15-0.21 (0.006-0.008)	0.35 (0.014)
	Side clearance	0.02-0.09 (0.001-0.00)	0.12 (0.005)

GENERAL INFORMATION

Cylinder head/valves Specifications

Unit: mm(in)

ITEM		STANDARD	SERVICE LIMIT
Electrically actuated cylinder pressure		1372kPa	-
Valve clearance	IN	0.16±0.03	-
	EX	0.27±0.03	-
Rocker arm, Rocker arm shaft	Arm I.D.	IN/EX 10.000-10.015	10.10
	Shaft O.D.	IN/EX 9.972-9.987	9.75
	Arm-to-shaft clearance	IN/EX 0.013-0.043	0.10
Camshaft	Cam lobe height	IN 30.3955-30.6355	30.376
		EX 30.1424-30.3824	30.122
	Oil clearance	0.020-0.062	0.10
	Runout	-	0.04
Valve, valve guide	Valve stem O.D.	IN 4.475-4.490	4.465
		EX 4.465-4.480	4.456
	Valve guide I.D.	IN/EX 4.500-4.512	4.54
	Stem-to-guide clearance	IN 0.005-0.042	0.07
		EX 0.015-0.052	0.08
	Valve guide height	IN/EX 14.10-14.30	-
Valve seat width	IN/EX 0.90-1.10	1.5	
Valve seat width	INNER IN/EX	29.78	28.58
	OUTER IN/EX	39.98	38.78
Cylinder head warpage		-	0.1

Clutch/Gearshift Linkage Specifications

Unit: mm(in)

ITEM		STANDARD	SERVICE LIMIT
Free clearance of clutch handle		10-20	-
Clutch	Spring free length	43.2	42.0
	Disc thickness	2.30-2.50	2.27
	Plate warpage	-	0.30
Clutch outer guide	I.D.	22.000-22.021	22.031
	O.D.	27.987-28.000	27.977
Mainshaft O.D. at clutch outer guide		21.967-21.980	21.95

GENERAL INFORMATION

Alternator/Starter Clutch Specifications

Unit: mm(in)

项目	标准	极限状态
Starter driven gear boss O.D.	51.705-51.718	51.685
Starter clutch outer I.D.	68.362-68.392	68.402

Crankcase/Transmission Specifications

Unit: mm(in)

ITEM		STANDARD	SERVICE LIMIT	
Transmission	Gear I.D.	M5	28.000-28.021	28.04
		C1	24.007-24.028	24.04
		C2	31.000-31.025	31.04
	Bushing O.D.	M5、M6	27.959-27.980	27.94
		C2	30.970-30.995	30.94
		C3、C4	30.950-30.975	30.93
	Gear-to-bushing clearance	M5	0.020-0.062	0.10
		C2	0.005-0.055	0.07
	Bushing I.D.	M5	25.000-25.021	25.04
		C2	28.000-28.021	28.04
Mainshaft O.D.	at M5 bushing	24.967-24.980	24.96	
	at C2 bushing	27.967-27.980	27.95	
Bushing-to-shaft clearance	M5、C2	0.020-0.054	0.07	
Shift fork /Fork shaft	Shift fork shaft O.D.	11.957-11.968	11.95	
	Shift fork I.D.	12.000 -12.018	12.03	
	Shift fork claw thickness	5.93-6.00	5.9	

Crankshaft/Piston/Cylinder/Balancer Specifications

Unit: mm(in)

ITEM		STANDARD	SERVICE LIMIT
Crankshaft	Connecting rod big end side clearance	0.05 - 0.20	0.25
	Crankpin bearing oil clearance	0.030 -0.052	0.06
	Main journal bearing oil clearance	0.017 -0.035	0.05
	Runout	-	0.05
Cylinder	I.D.	67.000 - 67.015	67.10
	Out-of-round	-	0.10
	Taper	-	0.10
	Warpage	-	0.10
Piston,Piston pin,Piston ring	Piston O.D.	66.970-66.990	66.905
	Piston pin hole I.D.	16.002-16.008	16.02
	Piston pin O.D	15.994-16.000	15.98
	Piston-to-piston pin clearance	0.002-0.014	0.04

	Piston ring end gap	Top	0.10-0.20	0.4
		Second	0.21-0.31	0.5
		Oil(side rail)	0.20-0.70	1.0
	Piston ring-to-ring groove clearance	Top	0.030-0.060	0.10
		Second	0.015-0.050	0.08
Cylinder-to-piston clearance			0.010-0.045	0.10
Connecting rod small end I.D.			16.030-16.044	16.05
Connecting rod-to-piston pin clearance			0.03-0.05	0.07

Front wheel/Suspension/Steering Specifications

Unit: mm(in)

ITEM		STANDARD	SERVICE LIMIT
Minimum tire thread depth		-	1.5 (0.06)
Cold tire pressure	Up to 90 kg (200 lbs) load	Front: 230kpa(2.35 kgf/cm ² , 33.4 psi) Rear: 250 kPa(2.55 kgf/cm ² , 36.0 psi)	-
	Up to maximum weight capacity	250 kPa (2.50 kgf/cm ² , 36 psi)	-
Axle runout		-	0.2 (0.01)
Wheel rim runout	Radial	-	2.0 (0.08)
	Axial	-	2.0 (0.08)
Wheel balance weight		-	Max. 60g(2.1oz)
Front suspension	Spring free length	581.5 (22.87)	
	Tube runout	-	0.2 (0.008)
	Recommended fork fluid	Colove suspension fluid KHL 15-10	-
	Fluid capacity	440±2cm ³ (14.88±0.07 US oz)15.5±0.07 Imp oz	-
Steering bearing pre-load		9.8-12.25 N (1.0-1.25 kgf. 2.2-2.75 lbf)	-

Rear wheel/Suspension Specifications

Unit: mm(in)

ITEM		STANDARD	SERVICE LIMIT
Minimum tire thread depth		-	2.0 (0.08)
Cold tire pressure	Up to 90 kg (200 lbs) load	250 kPa (2.55kgf/cm ² , 36 psi)	-
	Up to maximum weight capacity	250 kPa (2.55 kgf/cm ² ,36psi)	-
Axle runout		-	0.2 (0.01)
Wheel rim runout	Radial	-	2.0 (0.08)
	Axial	-	2.0 (0.08)
Wheel balance weight		-	Max. 60g(2.1oz)
Drive chain	Size/link	AFAM520C2/112	
	Slack	25-60(1.0-2.4)	
Shock absorber pre-load adjuster standard position		Reset damping: 2600-6000N	-
		Compression damping: 700-1750N	

Hydraulic Brake Specifications

Unit: mm(in)

ITEM		STANDARD	SERVICE LIMIT
Front	Specified brake fluid	DOT 4	-
	Brake pad wear indicator	-	To groove
	Brake disc thickness	4.0-4.05(0.157-0.159)	-
	Brake disc warpage	-	0.15 (0.006)
Rear	Specified brake fluid	DOT 4	-
	Brake pad wear indicator	-	To groove
	Brake disc thickness	4.0-4.05(0.157-0.159)	-
	Brake disc warpage	-	0.15 (0.006)

Battery/Charging System Specification

ITEM		STANDARD	
Battery	Type	MFZ103-RS(GEL)	
	Capacity	12V-8.6 Ah	
	Current leakage	1.5 mA	
	Voltage (28°C、68°F)	Fully charged	≥13.0V
		Needs charging	Below 12.6V or not use for 3 months
	Charging current	Normal	0.9A*5-10 h
Quick		4.5A*1 h	
Alternator	Capacity	400 W/9,000 rpm	
	Charging coil resistance (20°C/68°F)	0.1-1.0Ω	

Lights/Instrument/Switch Specifications

ITEM		SPECIFICATION
Bulb	Headlamp (far/near)	LED
	LED	LED
	Rear turn signal light	LED
	Brake/tail light	LED
	License light	LED
	Instrument light	LCD
	Turn signal indicator	LCD
	High beam indicator	LCD
	Air light	LCD
	Engine oil pressure indicator	LCD
	High coolant temperature indicator	LCD
	Fault light (MIL)	LCD
	ABS indicator	LCD
	Fuse	Main fuse
Sub-fuse		15A.10A.20A.1A(including ABS)
ABS Motor fuse		10A
ABS Main fuse		15A
ECT sensor resistance	40°C (104°F)	1.0-1.3KΩ
	100°C (212°F)	0.1-0.2KΩ

GENERAL INFORMATION

Torque Value

Standard torque values

FASTENER TYPE	TORQUE N. m(kgf. m, lbf. ft)	FASTENER TYPE	TORQUE N. m(kgf. m, lbf. ft)
5mm bolt and nut	5.2(0.5, 3.8)	5mm screw	4.2 (0.4, 3.1)
6mm bolt and nut	10(1.0, 7.4)	6mm screw	9.0 (0.9, 6.6)
8mm bolt and nut	22 (2.2, 16.2)	6mm flange bolt(8mm head: small flange)	10 (1.0, 7.4)
10mm bolt and nut	34 (3.5, 25.1)	6mm flange bolt(8mmhead: large flange)	12 (1.2, 8.9)
12mm bolt and nut	54 (5.5, 39.8)	6mm flange bolt(10mm head)and nut	12 (1.2, 8.9)
		8mm flange bolt and nut	27 (2.8, 19.9)
		10mm flange bolt and nut	39 (4.0, 28.8)

- . Torque specifications listed below are for specified fasteners.
- . Others should be tightened to standard torque values listed above.

Installation Site	QTY	Specification	Torque	Classification	Remark
Self-tapping nail connected with the rear plate light wire pressing plate and the rear small mud-retaining bracket	3	ST3.5X12	0.8	Electrical appliances, lights, switches	
Rear license plate lamp and rear small mudguard screw	2	M4*6*0.7	1	Electrical appliances, lights, switches	
The screw connecting the rear section of the rear mudguard to the tail cover	4	ST4.2*13	1	Exterior decoration	
Screws for the inner lining of the front guard plate of the fuel tank and the lower guard plate of the fuel tank	2	ST4.2*13	1	Exterior decoration	
Bolt of upper connecting board wire hook and upper connecting board	2	M5*16	6	Maneuvering, steering	
Bolts between the front section of the rear fender and the frame	2	M5*16	6	Exterior decoration, carrying	
Bolt of ECU and rear fender	2	M5*16	6	Electrical appliances, lights, switches	
Throttle cable card and handle screw	1	M5*0.8*8	1	Electrical appliances, lights, switches	
Screw for connecting headlight shell and headlight	3	M5*12	4	Electrical appliances, lights, switches	

Screw for connecting headlight back plate and headlight bracket	4	M5*12	4	Exterior decoration, carrying	
Left and right shock-absorbing decorative parts and shock-absorbing screws	8	M5*13	8	Exterior decoration, carrying	
Screws for the lower guard plate and inner lining of the fuel tank	10	M5*12	4	Exterior decoration, carrying	
Headlight rear guard plate and headlight screws	3	M5*12	4	Exterior decoration, carrying	
OBD and frame screws	2	M5*12	4	Electrical appliances, lights, switches	
Rear taillight and frame screws	2	M5*20	4	Electrical appliances, lights, switches	
The screws of the lower card seat of the instrument and the handle	2	M5*20	4	Electrical appliances, lights, switches	
Instrument cover and instrument screw	2	M5*20	4	Exterior decoration, carrying	
Screw connecting the roll switch to the frame	2	M5*20	4	Electrical appliances, lights, switches	
Screws for high-voltage package and frame	4	M5*35	4	Electrical appliances, lights, switches	
Screw connecting air filter and throttle body	3	M5*20	4	Cooling, intake and exhaust	
Oil pump and oil tank nut	6	M5*0.8*5*8	6	fuel	
Nut for connecting high-voltage package and frame	4	M5*0.8*5*8	6	Electrical appliances, lights, switches	
Threaded splint between EUC and rear fender	2	M5*1.0*7*14	4	Electrical appliances, lights, switches	

GENERAL INFORMATION

Installation Site	Q'T Y	Specifica tion	Torq ue	Classification	Remark
Threaded splint between the front section of the rear fender and the frame	2	M5*1.0*7*14	4	Exterior decoration, carrying	
Screws for rear gear ring and brake disc	5	M5*8	5	Brake、ABS	
Screws for headlights and headlight brackets	4	M5*16	4	Electrical appliances, lights, switches	
Horn and frame bolt	1	M6*12	12	Electrical appliances, lights, switches	
Front mudguard mounting bracket and shock-absorbing bolt	4	M6*12	12	Support, suspension	
Bolt of rear brake main pump	2	M6*12	12	Brake、ABS	
Seat cushion bracket and frame bolt	4	M6*12	12	Support, suspension	
Bolts for battery box and frame	3	M6*12	8	Electrical appliances, lights, switches	
The bolt connecting the oxygen sensor wire hook to the engine	2	M6*12	12	Cooling, intake and exhaust	
Bolt connecting water tank and water tank frame	3	M6*12	6	Cooling, intake and exhaust	
Bolt connecting ABS bracket and ABS	2	M6*12	12	Electrical appliances, lights, switches	
Seat cushion lock and frame bolt	2	M6*16	8	Support, suspension	
Bolt of the rear Brake oil cup	1	M6*16	8	Brake、ABS	
Bolt between the inner lining of the lower guard plate of the fuel tank and the frame	2	M6*20	8	Exterior decoration, carrying	
Water tank and frame bolt	1	M6*20	8	Cooling, intake and exhaust	
Bolt connecting gearshift rocker arm engine	1	M6*20	8	others	
Shift lever and rocker bolt	1	M6*20	10	others	
Shift lever and shift lever bolt	1	M6*20	10	others	
Rear Brake ejector rod bearing and Brake pedal bolt	1	M6*20	10	Brake、ABS	
Air filter and seat cushion bracket bolt	1	M6*20	8	Cooling, intake and exhaust	

Bolts between the front of the fuel tank and the frame	2	M6*22.5	8	fuel	
Bolt connecting ABS and frame	2	M6*28	8	Electrical appliances, lights, switches	
Bolt connecting voltage regulating rectifier and battery box	2	M6*28	8	Electrical appliances, lights, switches	
The bolts of the left and right brackets of the engine lower guard plate and the engine	6	M6*30	12	Exterior decoration, carrying	SCR 4 bolts
Screws of disc brake tee and lower connecting plate	1	M6*16	8	Brake、ABS	
Screws for front and rear turn signals	4	M6*20	6	Electrical appliances, lights, switches	
Brake return spring screw after hanging	1	M6*25	8	Brake、ABS	
Rear mudguard bracket and rear mudguard screws	3	M6*25	8	Exterior decoration, carrying	
Screws between the front end of the rear fender and the frame	2	M6*12	8	Exterior decoration, carrying	
Screws between the middle of the front section of the rear fender and the frame	2	M6*12	8	Exterior decoration, carrying	
Screws for chain box hooks and flat forks	1	M6*12	8	Brake、ABS	
Screw for rear wheel speed sensor	1	M6*12	8	Electrical appliances, lights, switches	
Screw for front wheel speed sensor	1	M6*12	8	Electrical appliances, lights, switches	

GENERAL INFORMATION

Installation Site	QTY	Specification	Torque	Classification	Remark
Screws for front fender and bracket	4	M6*12	8	Exterior decoration, carrying	
Screws for rear shock absorber and flat fork	2	M6*12	8	Exterior decoration, carrying	
Chain box and flat fork screws	2	M6*12	8	Exterior decoration, carrying	
Screw of sprocket guard (upper)	1	M6*12	8	Exterior decoration, carrying	
Screws of tail cover and frame	2	M6*12	8	Exterior decoration, carrying	
Screws for ignition lock cover and fuel tank	2	M6*12	8	Electrical appliances, lights, switches	
Screws between the lower part of the fuel tank guard plate and the frame	2	M6*12	8	Exterior decoration, carrying	
Screws for left and right side covers and frame	2	M6*12	8	Exterior decoration, carrying	
Screws of left and right fuel tank side guards and fuel tank	2	M6*12	8	Exterior decoration, carrying	
Screws for the rear section of the rear mudguard and the tail cover	1	M6*16	8	Exterior decoration, carrying	
Screw for side bracket flameout switch	1	M6*20	8	Electrical appliances, lights, switches	
Screws for engine guard plate and bracket (4 bolts SCR)	3	M6*20	8	Exterior decoration, carrying	
Screws of headlight bracket (upper) and upper connecting plate	1	M6*20	8	Exterior decoration, carrying	
Screw of sprocket guard (lower)	1	M6*25	6	Exterior decoration, carrying	
The screw connecting the rear billboard and the rear small mudguard	2	M6*12	6	Exterior decoration, carrying	
Screws for chain protection card	3	M6*12	6	Exterior decoration, carrying	
Screw connecting the rear brake oil pipe to the flat fork	3	M6*12	6	Brake、ABS	
Nut for shift lever adjustment	1	M6*1.0*5*10	5	others	
Nut for shift lever adjustment	1	M6*1.0*5*10	5	others	
Nut connecting the rear billboard and the rear small mudguard	2	M6*1.0*6*10		Exterior decoration, carrying	
Threaded splint for headlight adjustment	1	M6*1.0*8*16	1	Exterior decoration, carrying	

Screws for installing the rear disc brake rotor	5	M7*10*1	20	Brake、ABS	
Frame decoration cover and frame bolt	2	M8*12	22	Exterior decoration, carrying	
Bolt for rear disc brake pump and rear caliper bracket	2	M8*20	22	Brake、ABS	
Ignition lock and frame bolt	2	M8*20	22	Electrical appliances, lights, switches	
Bolts for front left and right pedals and frame	4	M8*30	22	Exterior decoration, carrying	
Bolts for front left and right disc brake calipers	4	M8*35	22	Brake、ABS	
Bolt connecting shift lever and left pedal	1	M8*35	22	others	
Bolt connecting the brake pedal to the frame	1	M8*35	22	Brake、ABS	
Bolt of muffler front section and frame	1	M8*45	22	Cooling, intake and exhaust	
Bolts for the rear section of the muffler and the right auxiliary pedal	1	M8*45	22	Cooling, intake and exhaust	
Fuel tank installation glue and frame screws	2	M8*25	22	fuel	

GENERAL INFORMATION

Installation Site	Q'T Y	Specification	Torque	Classification	Remark
Screws for rear fender and flat fork	3	M8*25	22	Exterior decoration, carrying	
Screws for locking the front wheel	2	M8*25	22	Front wheel, control, steering	
Orient the screws of the upper card socket and the upper connecting plate	4	M8*30	22	Front wheel, control, steering	
The upper and lower connecting plates lock the front shock-absorbing screws	6	M8*30	22	Front wheel, control, steering	
Screws for auxiliary pedal bracket and frame	4	M8*35	18	Exterior decoration, carrying	
Screws for the front left and right disc brake rotors	10	M8*24	30	Brake、ABS	
Screws for the front left and right disc brake rotors	2	M8*12	M10-30n.M/M 8-22n.M	Front wheel, control, steering	
Double-end screw and nut of upper connecting plate	2	M8*1.25*8.5*14	22	Front wheel, control, steering	
The front section of the muffler and the nut of the engine	4	M8*1.25*16.5*12	22	Cooling, intake and exhaust	
Bolt connecting rear brake inlet and outlet pipes with ABS	2	M10*1*22	22	Brake、ABS	
Bolts connecting the front brake oil pipes to the left and right front calipers	2	M10*1.25*22	22	Brake、ABS	
Bolt connecting front brake oil pipe and front brake pump	1	M10*1.25*22	22	Brake、ABS	
Bolt connecting the rear brake hose to the rear Brake caliper	1	M10*1.25*22	22	Brake、ABS	
Bolt of engine (front left)	1	M10*1.25*35	60	Exterior decoration, carrying	
Bolts on the rear shock absorber and the frame	1	M10*1.25*45	60	Exterior decoration, carrying	
Bolt of rear shock absorber and cradle	1	M10*1.25*52	60	Exterior decoration, carrying	
Engine (front right) bolt	1	M10*1.25*55	60	Exterior	

				decoration, carrying	
Engine bolt	2	M10*1.25*60	60	Exterior decoration, carrying	
Bolt for rear cradle and flat fork	1	M10*1.25*90	60	Exterior decoration, carrying	
Bolt of rear cradle	2	M10*1.25*110	60	Exterior decoration, carrying	
Bolts for engine rear suspension bolts	2	M10*1.25*150	60	Exterior decoration, carrying	
Side bracket bolt	1	M10*43.8	Bolt 2n. M, and then tighten the bolt six-way fixed fastening nut torque 22n. M	Exterior decoration, carrying	
Nut for rear sprocket cushion	6	M10*1.25*11.5*17	60	Exterior decoration, carrying	
The rear shock absorber connects the upper and the frame and the lower nut with the cradle	2	M10*1.25*11.5*17	60	Exterior decoration, carrying	
Nuts connected to the rear cradle	3	M10*1.25*11.5*17	60	Exterior decoration, carrying	
Nuts for the rear suspension of the engine	2	M10*1.25*11.5*17	60	Exterior decoration, carrying	
Nuts for side bracket bolts	1	M10*1.25*11.5*17	22	Exterior decoration, carrying	
Screw for eccentric locking bolt	2	M12*55	35	Exterior decoration, carrying	
Bolt connecting the upper link plate and the steering column	1	M14*30	80	Exterior decoration, carrying	
Nut for flat fork shaft fastening	1	M16*1.5*14.5*21	88	Exterior decoration, carrying	
Steering column adjusting nut nut	1	M25*1.0*10*44	The first stage is 40n.M, the second stage is loosened for two turns and the nut is tightened to	Front wheel, control, steering	

			10N. M, and the third stage is fixed in the direction of 1/4 turn		
Nuts for fastening the left and right rear axles	2	M38*1.5*15*45	168	Front wheel, control, steering	

GENERAL INFORMATION

Lubrication and sealing points

Engine

Material		Location	Remark
Sealant	1596	Crankcase bonding surface	
	1590	Air tank head cover seal ring	
Engine oil		The entire surface of the inner and outer rotor of the oil pump	
		The entire surface of the rocker shaft	
		Inner surface of rocker arm and roller surface	
		Valve stem sliding surface and stem end	
		The entire surface of the chain	
		Camshaft rolling surface	
		Inner surface of cylinder hole	
		Piston external surface, piston pin hole, piston ring groove	
		Outside surface of piston pin	
		The entire surface of the piston ring	
		The entire surface of the clutch friction disc	
		Clutch push rod sliding surface	
		Shift shaft rod part and dial plate	
		Dual gear shaft entire surface	
		Start over the entire surface of the clutch	
		The whole surface of the fork shaft	
		Inner surface of shaft bush of crankshaft connecting rod head	
		Gear teeth (primary drive, crankcase, start damping)	
		Disc tooth sliding surface	
		Each bearing rotation area	
	Each O - type sealing ring surface		
Molybdenum disulphide oil		Rocker arm	
		Rocker arm shaft	
		Camshaft surface	
		Cylinder head CAM shaft hole	
Multipurpose grease		Start the motor seal ring	
		Speed sensor seal ring	
Agent		All bonding surfaces	

GENERAL INFORMATION

Frame

Material	Location	Remark
Lithium base multipurpose extreme pressure grease NLGI2#	Sliding surface of the bearing housing ring	Each of 3-5 g (0.1-0.2oz)
	Dustproof seal of steering bearing	
Multipurpose grease	Slide area of side bracket rotating shaft	
	Sliding area of seat latch	
	Throttle handle pull wire slot and roll up area	
	Clutch lever sliding area	
	Front axle dust ring	
	Rear axle dust ring	
	Rear wheel hub o-ring	
	The rear shock absorber rolls the rotating area of the needle bearing	
	Dust proof sealing port of final drive flange	
	U-frame rotation area	
	Tripod rotation area	
	Swing needle bearing rotation area	
	Rotate the dustproof port	
	Shift pedal lever end bearing	
Gear shifting pedal swivel shaft sliding area		
Thermal conductive silicone	Front brake caliper shaft sliding area	0. 10 g (0 .004 oz)
	The contact area between the front brake calipers and the main piston	0. 10 g (0 .004 oz)
	Rear master cylinder push rod to contact area of main piston	0. 10 g (0 .004 oz)
	Rear brake pump dust jacket push rod installation area	0. 10 g (0 .004 oz)
	Front brake caliper pin sliding area	0. 4 g (0 .004 oz)
	Front brake caliper bracket pin sliding area	0. 4 g (0 .004 oz)
	Rear brake caliper pin bolt sliding area	0. 4g (0 .004 oz)
	Slide area of rear brake caliper adhesive sleeve	0. 4 g (0 .004 oz) (Inner)
	Brake caliper dust proof seal ring	
Brake caliper pin stop ring		

GENERAL INFORMATION

Material	Location	Remark
DOT4 Brake fluid	Brake main piston and rubber bowl	
	Rear main pump hose coupling o-ring	
	Brake clamp piston seal	
	External surface of brake clamp piston	
	Brake union nut thread	
Cable lubricant	Clutch cable	
	Throttle cable	
	Seat lock cable	
Colove Suspension KHL 15-10	Front shock seal seal lip	
	Front shock absorption dust seal lip	
	Front damping end cover o-ring	
Colove chain oil or equivalent	Entire surface of the drive chain	
High strength sealant (Letai 638 made by Letai, TB1305N made by Triple bond)	Buffer stud thread (driven flange side)	
Medium strength locking agent (TB1322N by Triple bond, 648 by Letai or equivalent)	Shock absorber mounting bolt thread	
	Rear master pump hose joint thread	
	Front brake clamp pin thread	
	Cooling fan nut thread	

Emission Control System

Exhaust emission requirements

According to the relevant regulations of EU Regulation No. 168/2013, it meets the requirements of Regulations No. 134/2014 and No. 2018/295, and can meet the requirements of environmental protection durability.

Noise emission requirements

According to the relevant regulations of EU Regulation No. 168/2013, comply with the requirements of standards and regulations No. 134/2014, No. 2018/295 and ECE R41-04.

Warranty compliance

In order for the emission system warranty to be valid, the dealer's limited warranty for the motorcycle emission control system must be followed.

Emission source

The combustion process produces carbon monoxide (CO), nitrogen oxides (NOx), and hydrocarbons (HC). Controlling hydrocarbons and nitrogen oxides is important because they react to sunlight to form photochemical smog. Carbon monoxide does not react in the same way, but it is toxic. Uncontrolled evaporation of fuel also releases hydrocarbons into the atmosphere. Colove uses variety of systems to reduce carbon monoxide, nitrogen oxides and hydrocarbons.

Crankcase emission control system

The engine is equipped with a closed crankcase system to prevent the release of crankcase emissions into the atmosphere. Channeling air returns to the combustion chamber through crankcase aeration hose [1] air filter shell [2] and throttle body [3].

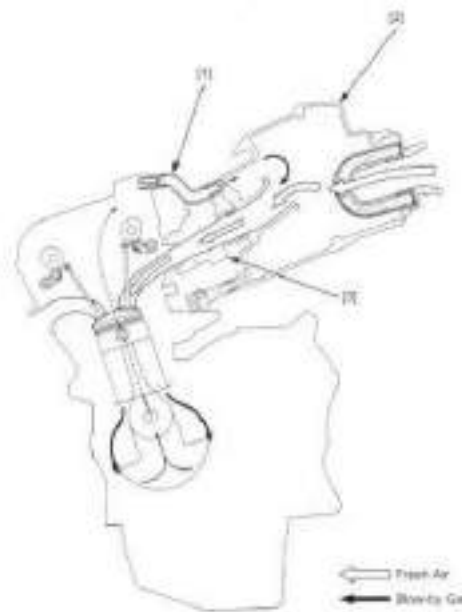

GENERAL INFORMATION

Emission control system

The exhaust gas emission control system is composed of pulse secondary air replenishment system, ternary catalytic converter and electric injection system.

Secondary air replenishment system

The pulse secondary air supply system introduces the filtered air into the exhaust port [1]. Fresh air is sucked into the exhaust port through the dual control solenoid valve [2] function.

This charge of fresh air promotes the combustion of unburned waste gas and converts large quantities of hydrocarbons and carbon monoxide into relatively harmless carbon dioxide and water vapor. Dual check valves [3] prevent reverse airflow through the system.

Paired control solenoid valves are controlled by an electric spray device and the fresh air passage is opened/closed according to operating conditions (CTIAT/TP/MAP sensors and engine revolution).

No adjustments to the secondary air supply system should be made, although periodic inspection of the components is recommended.

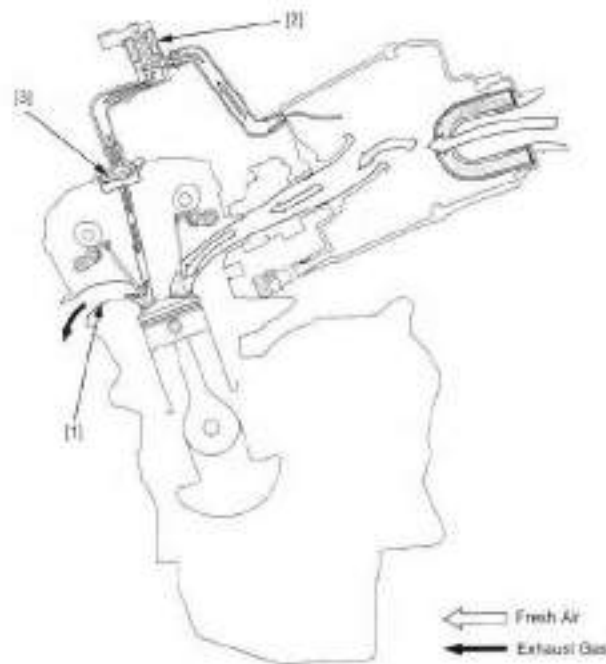
**Ternary catalytic converter**

The motorcycle is equipped with a three - way catalytic converter. Ternary catalytic converters convert hydrocarbons, carbon monoxide, and nitrogen oxides in engine exhaust to carbon dioxide (CO₂), nitrogen (N₂), and water vapor through chemical reactions.

GENERAL INFORMATION

Evaporation emission control system

This model complies with California Air Resources Board (CARB) evaporative emission requirements. Fuel vapor from the fuel tank [1] is routed into the EVAP canister [2] where it is absorbed and stored while the engine is stopped. When the engine is running and the evaporative emission cleaning control solenoid valve [3] is opened, the fuel vapor in the EVAP tank is drawn into the engine through the throttle body [4].

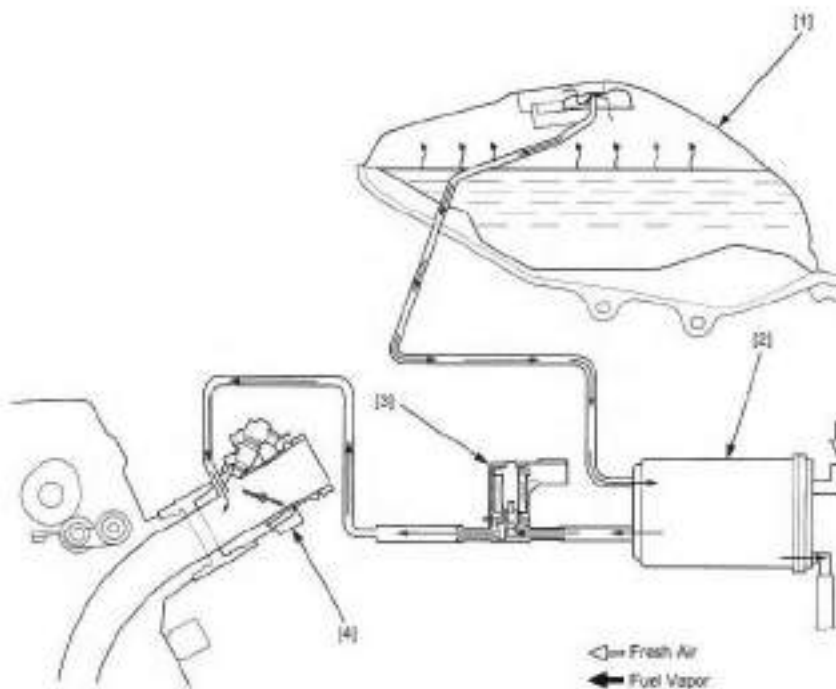
**Noise emission control system**

Tampering with the noise control system is prohibited. Federal law and the Canadian province laws that prohibit the following ACTS: (1) the vehicle sold or delivered to the end customer before or during the vehicle use, any artificial noise control purposes to any device or design elements in the vehicle dismantling or make it doesn't work, except for maintenance, repair or replacement (2) after anyone removed or disable design element using the vehicle.

Among those acts presumed to constitute tampering are the acts listed below:

1. Removal of, or puncturing of the muffler, baffles, header pipes or any other component which conducts exhaust gases.
2. Removal of, or puncturing of any part of the intake system.
3. Lack of proper maintenance.
4. Removing or disabling any emissions compliance component, or replacing any compliance component with a non-compliant component.

2.Frame/Body trim/Exhaust system

SERVICE INFORMATION	2-1	ENGINE LOWER PANEL	2-8
TROUBLESHOOTING	2-1	SMALL ENGINE SPROCKET COVER	2-9
BODY PANEL LOCATIONS/			
REMOVAL CHART	2-2	CHINA BOX AND REAR PEDAL STAND.....	2-9
SEAT	2-3	REAR WHEEL SMALL FENDER	2-10
SIDE COVER	2-3	ABS BRACKET	2-10
MIDDLE COWL	2-4	FUEL TANK GUARD PLATE	2-11
LINING OF FRONT GUARD			
PLATE OF FUEL TANK	2-4	SIDE STAND	2-11
REARVIEW MIRROR	2-5	PEDAL STAND	2-12
Instrument case	2-5	MUFFER	2-13
REAR COVER AND REAR FENDER.....	2-6		
REAR FENDER FRONT SECTION.....	2-7		
FRONT FENDER.....	2-8		

Frame/Body trim/Exhaust system

SERVICE INFORMATION:**GENERAL**

- . This section covers removal and installation of the body panels and exhaust system.
- . When disassembling , mark and store the mounting fasteners to ensure that they are reinstalled in their original locations.
- . When installing the covers , make sure the mating areas are aligned properly before tightening the fasteners.
- . Always replace the gaskets with new ones after removing the exhaust system.
- . When installing the exhaust system, loosely install all of the fasteners. Always tighten the exhaust pipe joint nuts first, then tighten the mounting bolt.
- . Always inspect the exhaust system for leaks after installation.

TROUBLESHOOTING**Excessive exhaust noise**

- . Broken exhaust system
- . Exhaust gas leak

Poor performance

- . Deformed exhaust system
- . Exhaust gas leak
- . Clogged muffler

BODY PANEL LOCATIONS/ REMOVAL CHART

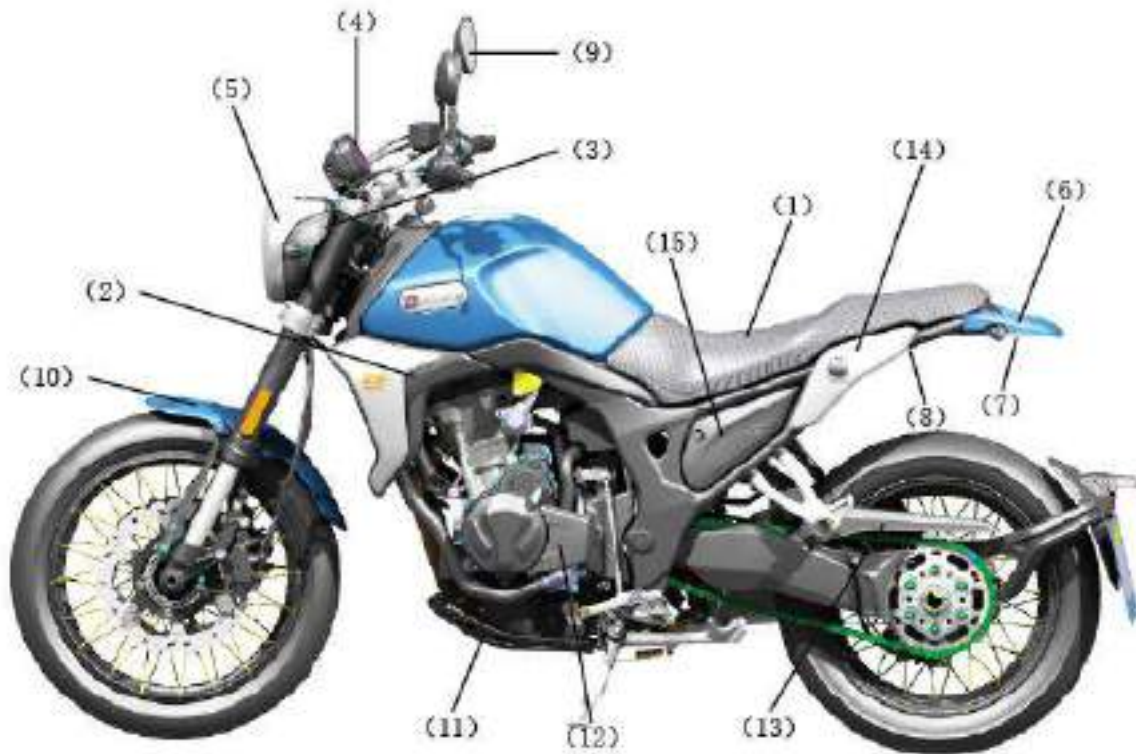

- | | | |
|--------------------------|----------------------------------|-----------------------------|
| (1) SEAT | (6) REAR FENDER | (11) UNDER COWL |
| (2) MIDDLE COWL | (7) REAR FENDER REAR SEGMENT | (12) DRIVE SPROCKET COVER |
| (3) BULB MAINTENANCE LID | (8) FRONT SECTION OF REAR FENDER | (13) DRIVE CHAIN COVER |
| (4) INSTRUMENT | (9) REARVIEW MIRROR | (14) FRAME DECORATION COVER |
| (5) HEADLIGHT TANK SHELL | (10) FRONT FENDER | (15) SIDE COVER |

This chart shows removal order of frame covers by means of arrow.

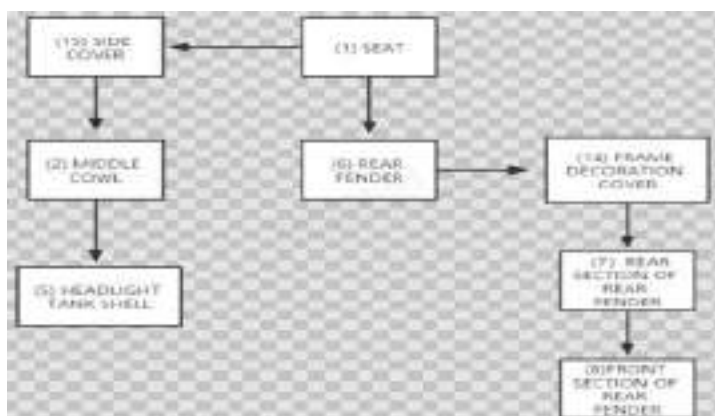

SEAT**REMOVAL/INSTALLATION****REAR SEAT**

Unhook the seat with the ignition key.
Remove the rear seat [1] by pulling it rearward.

Install the rear seat by inserting the prongs [2] under the frame.

Push down the rear of the seat securely to lock it.

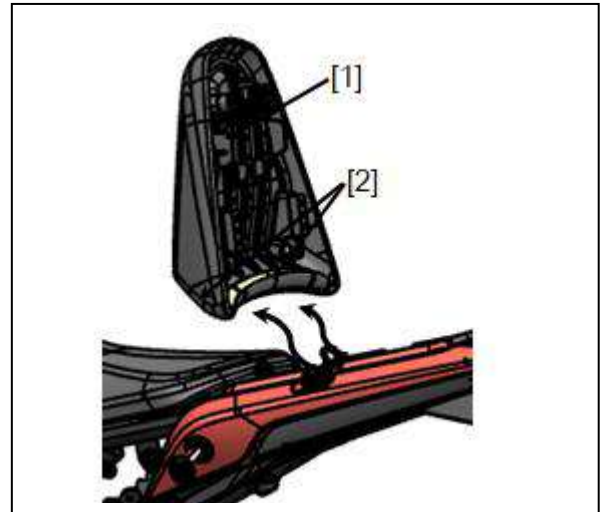
**SIDE COVER****REMOVAL/INSTALLATION****Remove the following:**

Fix inner hexagon step with M6 mm screw [1] and loose the lower mounting column [2].
Loosen mounting column [3] from washer from rear. Then remove the side cover.

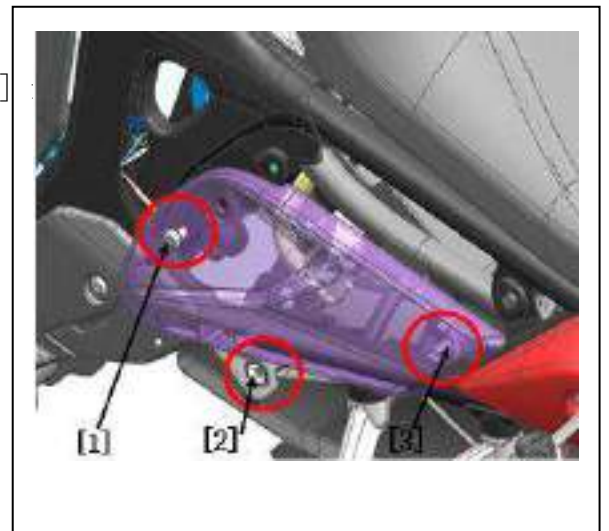
**NOTE:**

- Before installing the fasteners , be sure to set the two tabs into place properly.

MIDDLE COWL**REMOVAL/INSTALLATION**

Remove the following:

Remove the cross pan head screw from the fuel tank guard

Pull out position [1] forcefully to remove the lower guard plate of the tank

**LINING OF FRONT GUARD PLATE OF FUEL TANK****REMOVAL/INSTALLATION**

Remove the following:

2 (1 each on left and right) M6 hexagon flange bolts and flange bushings connected to the frame

Then pull it out, remove the hexagon socket step bolts, and remove the inner lining of the fuel tank front guard plate



REARVIEW MIRROR

REMOVAL/INSTALLATION

Remove the following:

Loosen lock nut **【1】** then loosen lock nut **【2】**

Remove the rearview mirror **【3】**

Installation is in the reverse order of removal.

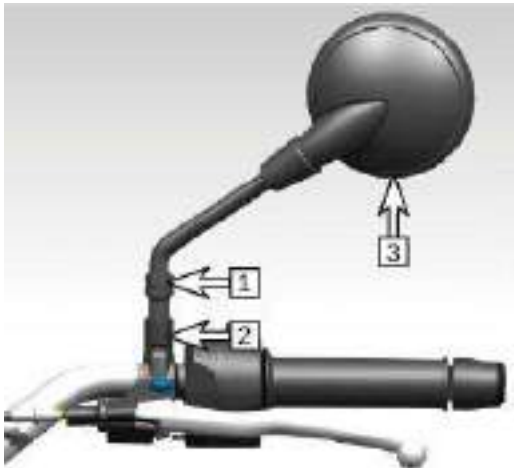

Instrument shell

REMOVAL/INSTALLATION

Remove the following:

Remove the two M5 cross recessed pan head screws at position **【1】** and remove the instrument cover

Disconnect the power plug cable at position **【2】**



Installation is in the reverse order of removal.

END CAP AND REAR SECTION OF REAR FENDER

REMOVAL/INSTALLATION

Remove the following:

- Remove the 3 M6 hexagon socket step screws connected to the frame at the position [1]
- Remove the 4 ST4.2 self-tapping screws connecting the rear part of the rear fender and the tail cover at position [2]
- Remove position [3] tail cover
- Remove the 2 M6 hexagon socket head cap screws connected to the rear part of the rear mudguard at position [6]
- After removing the position [4] (left/right) turn signal
- Remove position [5] Rear section of rear fender

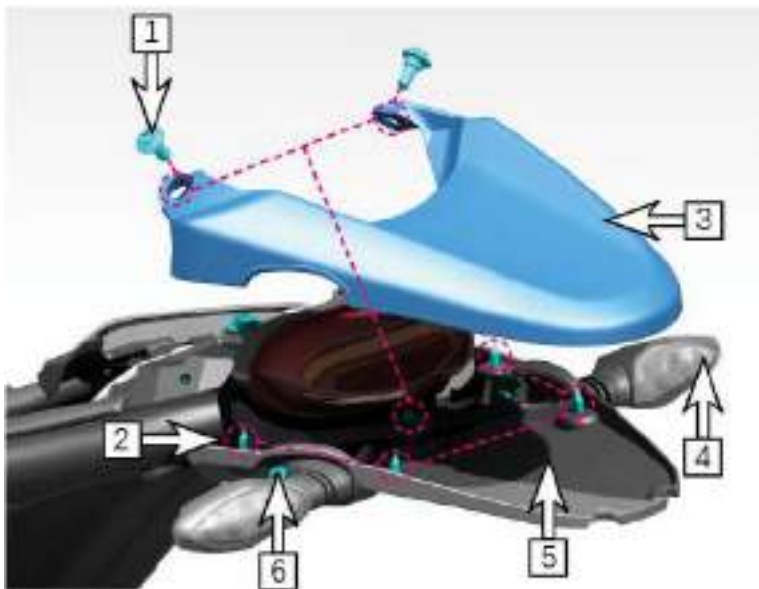

REAR FENDER

REMOVAL/INSTALLATION

Remove the following:

- Remove the 2 M6 hexagon flange bolts connected to the battery box at position [1], and remove the voltage regulating rectifier at position [2]
- Remove the battery strap at position [3], and remove the battery at position [4]
- Remove the starting relay at position [5]
- Remove the 3 M6 hexagon flange bolts at position [6], and remove the battery box
- Remove the 2 M5 hexagonal flange bolts and flange bushings at position [7], remove the 4 M6 hexagon socket pan head screws at position [8], and remove the rear fender at position [9] Front

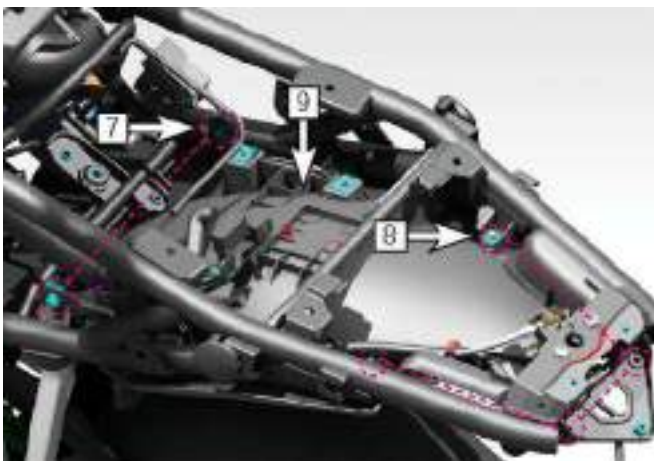
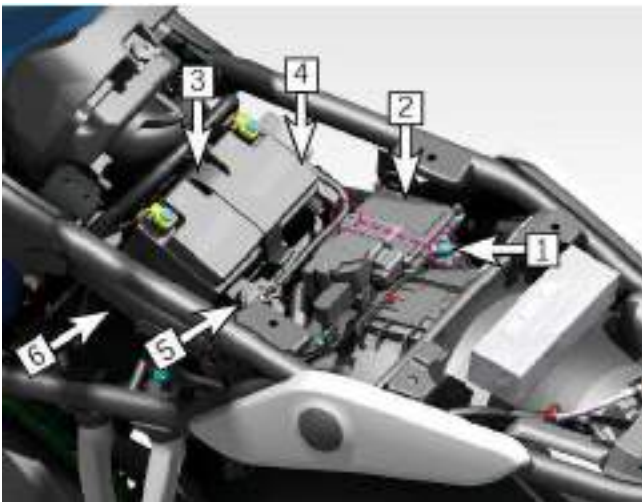

FRONT FENDER

REMOVAL/INSTALLATION

Remove the following:

Remove the 4 (2 on each left and right) M6 hexagon socket step screws that are connected to the front fender bracket at position [1], and remove the front fender at position [2]. Installation is in the reverse order of removal.



UNDER COWL

REMOVAL/INSTALLATION

Remove the following:

Remove the three M6 hexagonal flange bolts and the turn-over bushings at the position [1], and remove the engine lower guard plate [2]. The installation sequence is the reverse of the removal sequence.

SCR: Remove the 2 left and right M6 hexagonal flange bolts and turn-over bushings at the position [1], and remove the engine lower guard plate [2]. The installation sequence is opposite to the removal sequence.

(SCR)



ENGINE SPROCKET COVER

REMOVAL/INSTALLATION

Remove the following:

Remove the left pedal stand.

Remove one M6 hex flange bolt at position [1] and remove the shift arm at position [2]

Remove M6 and M10 inner hexagon step screw (one for each) at position [3], and remove sprocket cover at position [4]

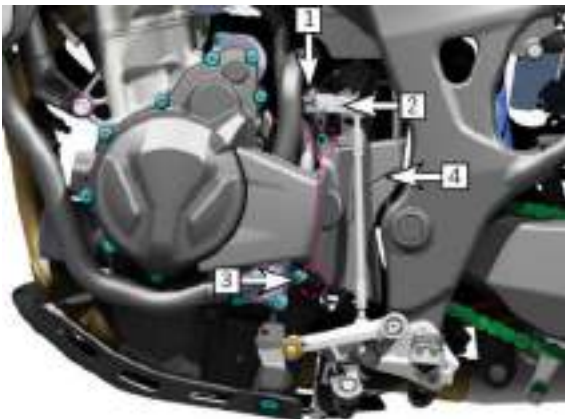

CHAIN BOX AND REAR PEDAL BRACKET

REMOVAL/INSTALLATION

Remove the following:

- Remove the left rear pedal bracket
- Remove the two M8 inner hexagonal cylindrical head screws at position [1] and remove the rear pedal bracket at position [2]
- Remove the two M6 inner hexagon step screws at position [3] and remove the chain box at position [4]

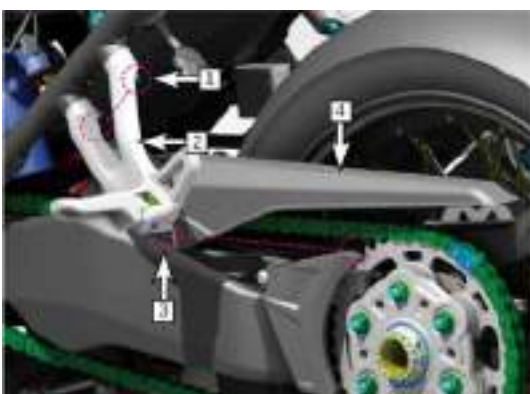

REAR WHEEL SMALL FENDER**REMOVAL/INSTALLATION**

Remove the following:

- Remove the three M8 inner hexagon cylindrical head screws at position [1]
- Remove position [2] rear license plate light conversion wiring
- Remove position [3] small rear wheel fender

**ABS BRACKET****REMOVAL/INSTALLATION**

Remove the following:

- Remove the two M6 hex flange bolts at position [1]
- Remove the position [2] ABS bracket

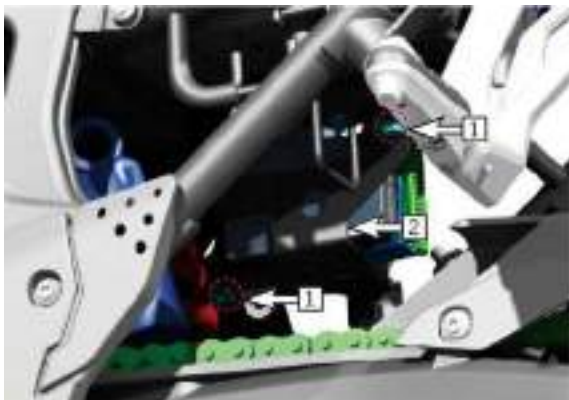

TANK ARMOR

Remove the following:

Remove the two M6 hex flange bolts at position [1] and remove the front guard plate of the oil tank at position [2]



SIDE STAND

REMOVAL/INSTALLATION

Remove the following:

Remove the spring at position [1]; Remove pivot bolts and nuts at position [2]; Remove the flameout switch in position [4]; Remove the side support at position [3]

The installation sequence is opposite to the removal sequence.

Note:

Grease the pivot area, tighten the pivot nut, firmly fix the pivot bolt, spring installation direction as shown in the figure

Torque:

Pivot nut: 2-4 N.m



LEG SUPPORT

REMOVAL/INSTALLATION

Remove the following:

- Remove the shift lever at position [1]
- Remove the two M8 hex flange bolts at position [2]
- Remove the foot support at position [3]

The installation sequence is opposite to the removal sequence.

Torque:

Front foot support bolt:

18N.m

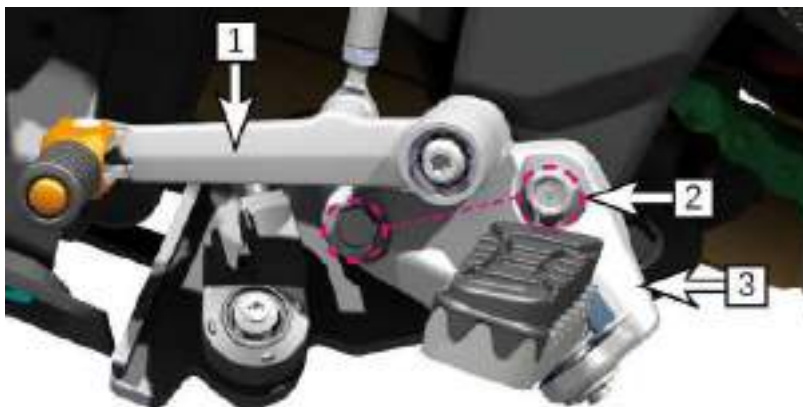

Muffler

REMOVAL/INSTALLATION

Remove the following:

- Loosen the bolt of hoop lock at position [1]
- Remove the M8 hex flange bolts at position [2]
- Remove the rear section of the muffler [3]
- Remove one M8 hex flange bolt at position [6]
- Remove the four M8 cover nuts at position [4]
- Remove the front section of position [5] muffler

Disconnect the O2 sensor 4P (black) connector and remove the O2 sensor lead from the frame

Install the exhaust pipe flange to the studs using mounting bolts and connecting nuts and screw all fasteners in completely.

First tighten the connecting nut to the specified torque, then tighten the mounting bolt.

Torque: Exhaust pipe connection nut:

22 N.m (2.2 kg.m, 16 lbf.lf)

The installation sequence is opposite to the removal sequence.

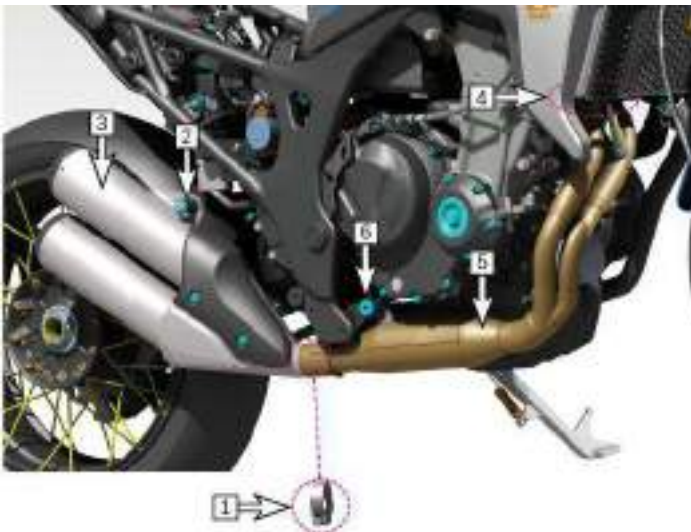

Replacement of stud

Disassembly exhaust pipe.

Screw two nuts to the stud and tighten them together, then use a wrench on the inner nut to unscrew the stud and install the new stud with short thread to the cylinder head.

Tighten the stud to the required torque.

Torque: 9.0 N.m (0.9 kgf.m, 6.6 lbf.ft)

After installation, check whether the length from the bolt head to the cylinder head surface is within the specification range.
Installation of exhaust pipe.

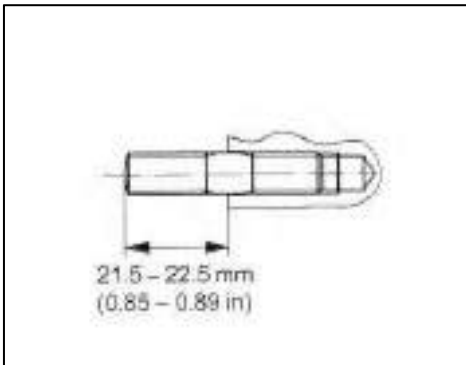

3.MAINTENANCE

SERVICE INFORMATION -----	3-1	BRAKE FLUID -----	3-11
MAINTENANCE PLAN -----	3-2	BRAKE PAD WEAR -----	3-13
FUEL LINE -----	3-3	BRAKE SYSTEM-----	3-14
THROTTLE OPERATION -----	3-4	BRAKE LIGHT SWITCH-----	3-14
AIR CLEANER -----	3-5	HEADLIGHT AIM-----	3-15
CRANKCASE BREATHER -----	3-6	CLUTCH SYSTEM-----	3-15
SPARK PLUG -----	3-7	SIDESTAND -----	3-16
COOLING SYSTEM -----	3-8	SUSPENSION-----	3-17
SECONDARY AIR SUPPLY SYSTEM -----	3-8	NUTS, BOLTS, FASTENERS-----	3-18
DRIVE CHAIN -----	3-9	WHEELS/TIRES-----	3-18
		STEERING BEARING -----	3-18

SERVICE INFORMATION

GENERAL

- Place the motorcycle on a level surface before starting any work.

MAINTENANCE

Please check the maintenance items in the maintenance table according to the operation manual.

I: Inspect and Clean, Adjust, Lubricate or Replace if necessary; R: Replace; A: Adjust; L: Lubricate.

The following items require some mechanical knowledge. Certain items (particularly those marked * and **) may require more technical information and tools. Consult a dealer.

Maintenance item list

		Project	Odometer Km(note 1)				
		Cycle	1000Km	4000Km	8000Km	12000Km	
*	FUEL LINE						
*	FUEL FILTER					R	
*	THROTTLE OPERATION						
	AIR CLEANER	Note 2			R		
*	SPARK PLUG						
	EXHAUST VALVE CLEARANCE						
	INLET VALVE CLEARANCE						
*	ENGINE OIL		500Km、1500Km、replace every 5000Km thereafter.				
*	ENGINE OIL FILTER		Replace the oil when you change it.				
*	TENSIONING OF TIMING CHAIN		A	A	A	A	
	EFI SYSTEM						
	DRIVE CHAIN			、L	、L	、L	
	BATTERY	Monthly					
	BRAKE PAD WEAR						
**	BRAKE SYSTEM						
*	HEADLIGHT AIM						
*	SUSPENSION						
**	FASTENERS						
**	STEERING HEAD BEARINGS						

*Should be serviced by a dealer, unless the owner has proper tools and service data and is mechanically qualified.

** In the interest of safety, we recommend these items be serviced only by a dealer.

NOTES:

- 1、At higher odometer readings , repeat at the frequency interval established here.
- 2、Service more frequently when riding in unusually wet or dusty areas.
- 3、Service more frequently when riding in rain or at full throttle.
- 4、Replace every 2 years , or at indicated odometer interval , whichever comes first.
Replacement requires mechanical skill.

FUEL LINE

FUEL TANK LIFTING/LOWERING

REMOVAL/INSTALLATION

Remove the following:

Remove the middle cowls.

Remove four bolts [1], turn over the bushing [2] and i-ring [3].

Disconnect fuel pump 3P (black) connector [4] slightly lift the front of fuel tank [5] and disconnect the following components [6] fuel tank to EVAP carbon tank hose [7] [5] fuel tank drain hose [6].

Place appropriate support blocks between the air filter shell (plane surface area) and the tank to support the fuel tank.

Installation is in the reverse order of removal.

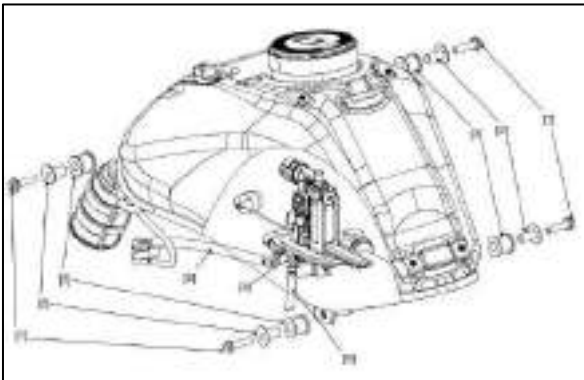

NOTE:

Be sure to route the fuel feed hose into the guide in the air cleaner housing. Check whether fuel tank vent hose and fuel tank drain hose are bent or compressed.

TORQUE:

Fuel tank mounting bolt: 22N .m (2.2 kgf.m, 16 lbf.ft)

INSPECTION

Lift the fuel tank and support it.

Check the fuel feed hose for deterioration, damage or leakage.

Also, check the hose fittings for damage or looseness.

Replace the fuel feed hose if necessary.

THROTTLE OPERATION

Check whether the throttle cable is degraded or damaged, check whether the handle switch is working smoothly; check whether the throttle valve is opened and automatically closed at all steering positions. If the handle switch cannot be returned correctly, lubricate and repair the handle switch housing; if the throttle valve If the gripper still cannot return correctly, replace the throttle cable.

When the engine is idling, turn the handlebar to the right and left to ensure that the idling speed does not change. If the idling speed increases, check the free gap of the handle switch and the throttle cable wiring. Measure the free gap of the throttle handle at the flange of the handle switch

FREEPLAY: 2-6mm (0.1-0.2in)



The throttle gripping free gap can be adjusted at either end of the throttle cable. Use the upper adjuster on the throttle handle for fine adjustment.

Loosen the mounting screw at position [1] and turn the adjuster at position [2] as needed. Tighten the lock nut to the specified torque while fixing the adjuster

TORQUE:5 N.m (0.5 kgf.m, 3.7 lbf.ft)



Install the sheath correctly on the regulator. Make major adjustments through the lower regulator on the throttle body. Lift the fuel tank and support it. Loosen the lock nut at position [2], and turn the adjuster at position [1] as needed. While fixing the adjuster, tighten the lock nut to the specified torque. After adjustment, recheck the throttle operation .Install fuel tank

TORQUE: 3.0 N.m (0.3 kgf.m, 2.2 lbf.ft)

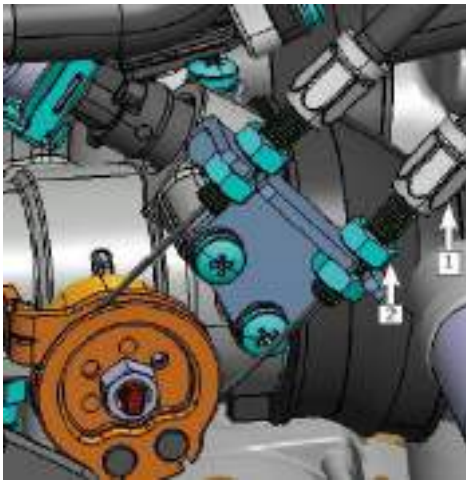

AIR CLEANER

Remove the battery.

REMOVAL/INSTALLATION

Remove the following:

Remove the 4 ST4.2 Phillips pan head tapping screws at position [1], and remove the air filter cover at position [2]

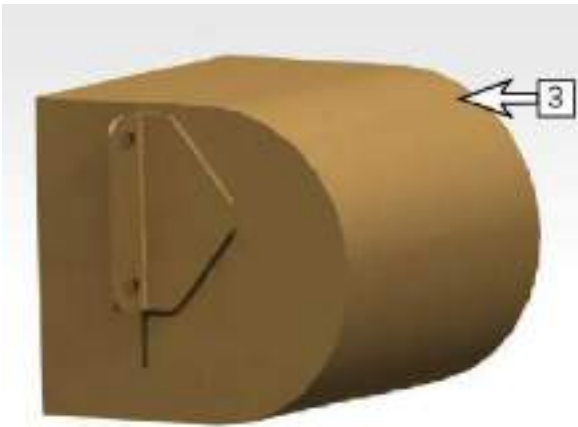

Take out the air filter element at position [3]

**Notice:**

Adhesive paper filter element type air filter cannot be cleaned because the filter element contains dust binder. If the motorcycle is used in an unusually humid or dusty place, more frequent inspections are required. According to the MAINTENANCE plan or any time the air filter element is Dirty or damaged, replace the air filter element. Clean the air filter cover and the inside of the housing. The installation sequence is opposite to the removal sequence.

TORQUE:

Air filter cover self-tapping screw : 1.1 N.m (0.1 kgf.m, 0.8 lbf.ft)

CRANKCASE BREATHER**NOTE:**

- .Service more frequently when ridden in rain , at full throttle, or after the motorcycle is washed or overturned .
- Service if the deposit level can be seen in the transparent tube.
- Remove the crankcase breather tube plug and drain the deposits into a suitable container, then reinstall the plug securely.

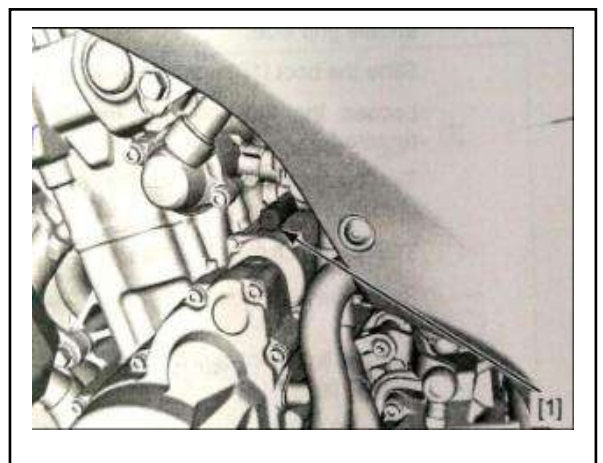

Lift the fuel tank and support it. Check the crankcase breather hose [1] for cracks, deterioration, damage or loose connections. Replace the breather hose if necessary. Install the fuel tank.



SPARK PLUG

Remove the spark plug at the oil tank and position [1], and check whether the insulator is cracked or damaged, and whether the electrode is damaged, dirty or discolored. Replace the spark plug if necessary. Use a wire or a dedicated spark plug cleaner to clean spark plugs

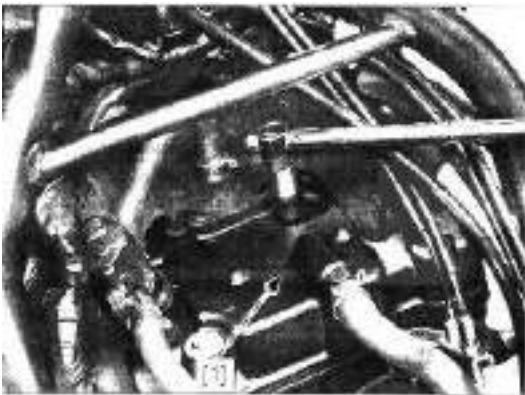

Note:

Before removing the spark plugs, clean the area around the spark plug base with an air gun and make sure no dust falls into the combustion chamber. Spark plug electrodes. Check the gap between the center electrode and the side electrode with a plug gauge

Specified spark plug: 0.80-0.90 mm (0.031-0.035 in)

If necessary, adjust the gap by bending the side electrode carefully.

Install and hand tighten the spark plug to the cylinder head, then tighten the spark plug to the specified torque.

Torque: 16 N.m (1.6 kgf.m, 12 lbf.ft)

COOLING SYSTEM

Check the radiator air passages in the for clogging the or damage.

Straightened bent fins with a small flat blade screwdriver and remove insects, mud or other obstructions with compressed air or low water pressure.

Replace the radiator if the air flow is restricted over more than 20% of the radiating surface. Remove the middle cowls.

Check for any coolant leakage from the water hoses and hose joints.

Check the water hoses for cracks or cracks and replace them if necessary.

Check that all clamps are tigh.

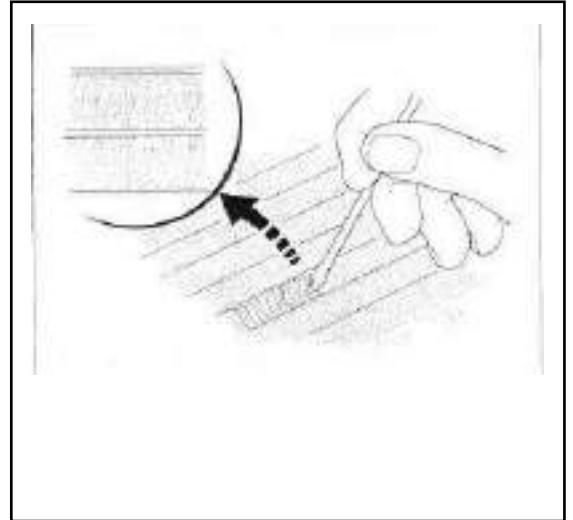

EVAPORATIVE EMISSION CONTROL SYSTEM

Remove the fuel tank under tray.

Check the EVAP canister [1] for cracks or damage.

Check the hoses between the fuel tank [2], EVAP canister, EVAP purge control solenoid valve [3] and throttle body [4] for

deterioration, damage or loose connections.

Also, check that the hoses are not kinked or pinched. Refer to the Cable & Harness Routing for hose connections and routing.

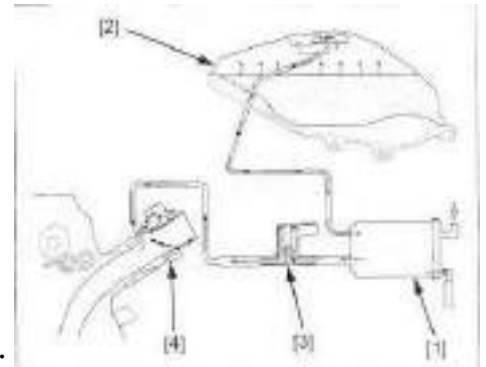

DRIVE CHAIN

Check for chain slack, turn off the ignition, position the motorcycle vertically, and shift the gearbox to neutral. Check the slack of the lower part of the intermediate drive chain of the sprocket.

DRIVE CHAIN SLACK: 25-40 mm (1.0 -1.6in)

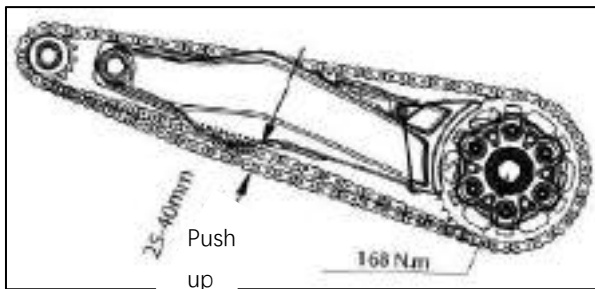

Note:

Excessive loose chain, 40mm(1.6in) or larger, may damage the frame. Never check the adjusting drive chain while the engine is running.

ADJUSTMENT

Put the transmission into neutral and turn off the engine. Motorcycle vertically on a solid flat on the ground, remove chain box and the rear fender support, loosen after 2 flat fork lock bolt, phillips screwdriver inserted into the adjustment holes respectively, with two rotating tires adjusted chain wheel Angle, sag, and check the chain in the chain guard card rear area, drive in the direction of flat fork chain, in order to determine reasonable sag of the chain.

REAR FLAT FORK LOCKING BOLT

Torque: 35N.m (3.6 kgf.m, 25.8 lbf.ft)



CLEANING AND LUBRICATION

Clean the drive chain [1] with a chain cleaner designed specifically for O-ring chains or a neutral detergent.

Use a soft brush if the drive chain is dirty.

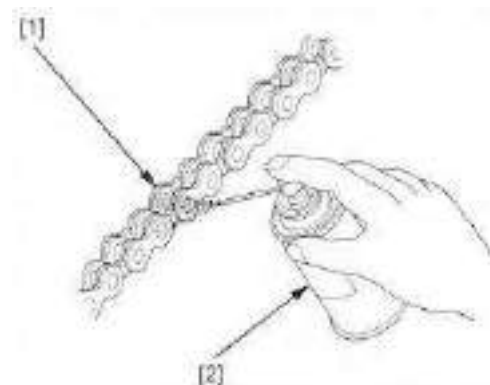

Note:

Do not use steam cleaners, high pressure cleaners, wire brushes, abrasive cleaners with volatile solvents such as gasoline and benzene, or chain cleaners not specifically designed for O-chains to clean the drive chain. Do not lubricate the drive chain with chain lubricants that are not specifically designed for o-ring chains. Wipe off excess oil or transmission chain lubricant. Check drive chain for possible damage or wear. Replace any drive chain with damaged rollers, loose links or faulty links. Make sure the drive chain is completely dry before lubrication. Use chain lubricant or equivalent [2] to lubricate the transmission chain.

SPROCKET INSPECTION

Remove small sprocket cover. Inspect small sprocket and large sprocket teeth for wear or damage and replace if necessary. Never use a new chain on a worn sprocket. Both chains and sprockets must be in good condition or the new replacement chain will wear out quickly. Check connecting bolts [1] and nuts on small sprocket and large sprocket in position, tighten to specified torque if loose

SMALL SPROCKET ASSEMBLY BOLT **[1]**

TORQUE: 45N.m (4.5 kgf.m, 33 lbf.ft)



BRAKE FLUID

Spilled fluid can damage painted, plastic or rubber parts. Place a rag over these parts whenever the system is serviced.

NOTE:

.Do not mix different types of fluid , as they are not compatible with each other.

.Do not allow foreign material to enter the system when filling the reservoir.

.When the fluid level is low, check the brake pads for wear.

A low fluid level may be due to wear of the brake pads. If the brake pads are worn and caliper pistons are pushed out, this accounts for a low fluid level. If the brake pads are not worn and fluid level is low, check the entire system for leaks.

FRONT BRAKE

Turn the handlebar so the reservoir is level and check the front brake fluid level through the sight glass.If the level is near the "LWR" level line[1], fill the brake fluid as follows.



Remove the following:

Remove the following:

-2 screws[1]

-reservoir cap[2]

-set plate[3]

-diaphragm[4]

Fill the reservoir with DOT 4 brake Fluid from a sealed container to the upper level line (casting ledge) [5] .

Install the diaphragm, set plate and reservoir cover, and tighten the screws to the specified torque.

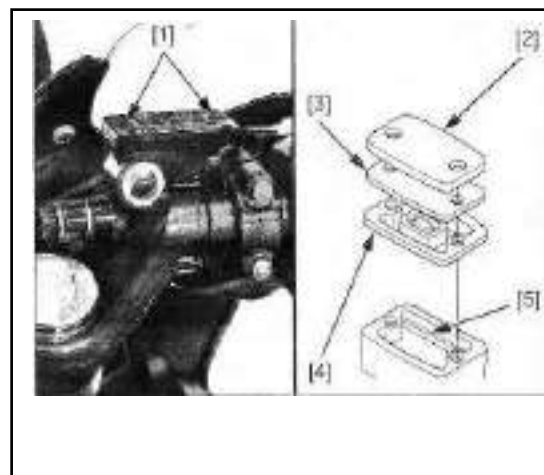

TORQUE: : 3 N.m (0.3 kgf.m, 2 lbf.ft)

REAR BRAKE

Support the motorcycle upright position on a level surface and check the rear brake fluid level. If the level is near the "LOWER" level line [1], fill the brake fluid as follows.



Remove the following:

- reservoir mounting bolt[1]
- 2 screws[2]
- reservoir cap[3]
- set plate[4]
- diaphragm[5]

Add DOT 4 brake fluid from the sealed container to the upper level of the tank.

TORQUE: 3 N.m (0.3 kgf.m, 2 lbf.ft)

NOTE: Be careful not to let the liquid overflow from the storage tank

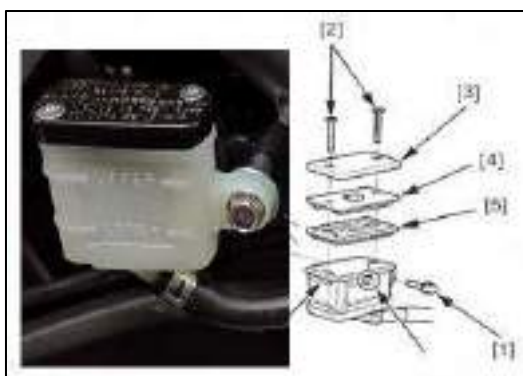

BRAKE PAD WEAR

FRONT BRAKE PADS

Check the brake pads for wear. Replace the brake pads if either pad is worn to the wear limit groove [1].

Note: Be sure to replace the Brake plates in sets to ensure that the pressure of the Brake disc is uniform.



REAR BRAKE PADS

Check the brake pads for wear. Replace the brake pads if either pad is worn to the wear limit groove [1].

Note: Be sure to replace the Brake plates in sets to ensure that the pressure of the Brake disc is uniform.



BRAKE SYSTEM

INSPECTION: Firmly apply the brake lever or pedal, and check that no air has entered the system. If the lever or pedal feels soft or spongy when operated, bleed the air from the system.

Inspect the brake hoses [1], pipes and fittings for deterioration, cracks, damage and signs of leakage. Tighten any loose fittings. Replace hoses, pipes and fittings as required.

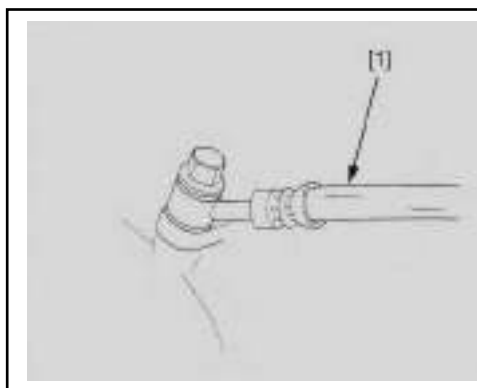

BRAKE LIGHT SWITCH

NOTE: The brake light switch on the front brake master cylinder cannot be adjusted. If the front brake light switch actuation and brake engagement are not synchronized, either replace the switch unit or the malfunctioning parts of the system. Check that the brake light comes on just prior to the brake actually being engaged. If the light fails to come on, adjust the switch so that the light comes on at the proper time. Hold the switch body [1] and turn the adjuster [2]. Do not turn the switch body.

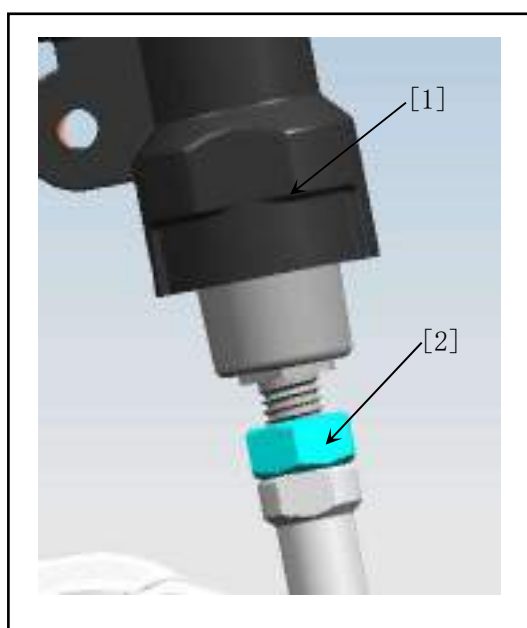

Headlight beams

Note: Adjust headlights according to local laws and regulations. The motorcycle is supported vertically on the horizontal plane and adjusted by turning the adjusting screw (underside) at position [1]. If the regulator is placed too far away, it may damage the regulator and minimize the engagement of the threads.

Clockwise rotation causes the beam to move downward; The counterclockwise rotation moves the beam upward



CLUTCH SYSTEM

Inspect the clutch cable for kinks or damage, and lubricate the cable if necessary. Measure the clutch lever freeplay at the end of the clutch lever.

FREEPLAY: 10-20mm (0.4-0.8in)

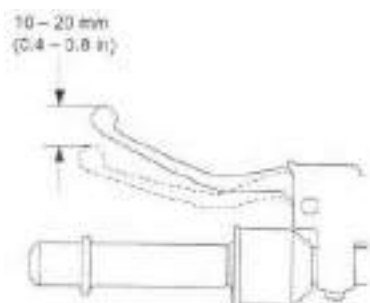

Fine tuning is carried out by an upper regulator on the clutch lever. Loosen the lock nut at position [1] and turn the regulator at position [2] as required, tighten the lock nut while fixing the regulator. If the regulator is unscrewed near the limit and the correct free clearance cannot be obtained, the regulator is fully screwed and unscrewed, and the following adjustment is performed at the main regulator.



Use the adjustment nut at the lower position [1] of the clutch tappet arm for main adjustment. Loosen the lock nut at position [2] and adjust the nut as required. Tighten the locking nut while securing the adjusting nut. If proper free clearance is not available, or if the clutch slips during a test drive, disassemble and inspect the clutch



SIDESTAND

Use a safety brace or crane to support the motorcycle. Inspect side support springs for damage or loss of tension. Check for movement of the side support and lubricate the pivot of the side support if necessary.

Check the side support ignition and cut-off system:

1. Sit astride the motorcycle and take back the side stand.
2. Start the engine with the gearbox in neutral, then pull the gearbox into gear while squeezing the clutch lever.
3. Lower the side supports completely.
4. Engine should stop when side bracket is lowered.

If there is a problem with the system, check the side support switch.



SUSPENSION

FRONT SUSPENSION INSPECTION

Check the action of the forks by operating the front brake and compressing them several times . Check the entire fork assembly for signs of leaks, damage or loose fasteners. Replace damaged components which cannot be repaired. Tighten all fasteners. For fork service.

REAR SUSPENSION INSPECTION

Check the action of the shock absorber by compressing them several times. Check the entire shock absorber assembly for leaks, damage or loose fasteners . Replace damaged components which cannot be repaired. Tighten all fasteners. For shock absorber service. Support the motorcycle using a hoist or equivalent and raise the rear wheel off the ground. Check for worn swingarm bearings by grabbing the swingarm ends and attempting to move it side to side. Replace the bearings if any looseness is noted. For swingarm service.

REAR SUSPENSION ADJUSTMENT

SPRING PRE-LOAD ADJUSTER

The compression damping and recovery damping can be adjusted by turning the regulator.

TOOL: Pin spanner

Adjust the position as shown in the figure

A: Rotate the compression damping clockwise

B: The needle rotates the recovery damping

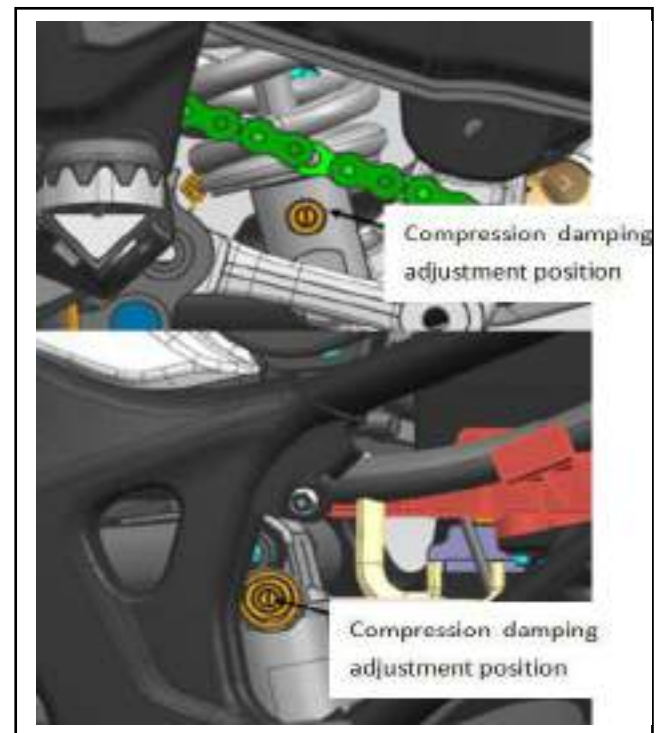

NUTS, BOLTS, FASTENERS

Check that all chassis nuts, screws and bolts are tightened to their correct torque values .

Check that all cotter pins, safety clips, hose clamps and cable stays are in place and properly secured.

WHEELS/TIRES

Support the motorcycle with a crane or equivalent, and lift the front wheel off the ground, hold the front shock absorption, and forcibly move the front wheel sideways to check whether the wheel bearing is worn.

FRONT WHEEL REPAIR

Support the motorcycle with a crane or equivalent and lift the front wheel off the ground. Hold the switch and forcefully move the rear wheel sideways to see if the wheel and driven flange bearings are worn.

THE REAR SERVICE

Check the tire pressure with the tire pressure gauge when the tire is cold.

- the front tyre
- after the tyres

Check tires for incisions, embedded nails, or others damage. Check the front and rear wheels are correct. Measure the tread depth in the center of the tire. Replace the tire when the tread pattern depth reaches the service limit.

STEERING BEARING

Support the bike with a crane or equivalent, lift the front wheel off the ground and check that the handlebars move freely from side to side. Make sure the control cable does not interfere with the rotation of the handle. Grab the damper and try to move the front damper forward and backward, checking the directional column bearings. If the handlebars move unevenly, stuck, or vertically, check the steering bearings

SERVICE INFORMATION-----	4-1
SYSTEM LOCATION -----	4-2
EFI SYSTEM MAINTENANCE INSTRUCTIONS-----	4-3
INTRODUCTION TO SYSTEM FAULT DIAGNOSIS -----	4-4
SYSTEM FAULT DIAGNOSIS -----	4-9

SERVICE INFORMATION:**GENERAL**

- This section covers electrical system service of the Efi system. For other service and fuel supply system, see Fuel System section.
- The Efi system is equipped with the self-diagnostic system. When performing the troubleshooting, read "Efi Troubleshooting Information" carefully, and inspect and troubleshoot according to the OTC.
- A faulty Efi system is often related to poorly connected or corroded connectors. Check those connections before proceeding.
- Use a digital tester for Efi system inspection.
- The inlet pipe absolute pressure, inlet temperature and throttle position sensors are integrated in a sensor unit located on the left side of the throttle body of both cylinders. The absolute pressure of the inlet pipe and the absolute pressure sensor of the inlet pipe are measured at the left side of the throttle body (no. 1) cylinder head. The engine control module (ECU) is measured according to the left cylinder.
- The following color codes used are indicated through out this section.

Bl=Black	G=Green	Lg=Light Green	R=Red	Y=Yellow
Br=Brown	Gr=Gray	O=Orange	V=Violet	
Bu=Blue	Lb= Light Blue	P=Pink	W=White	

SYSTEM LOCATION

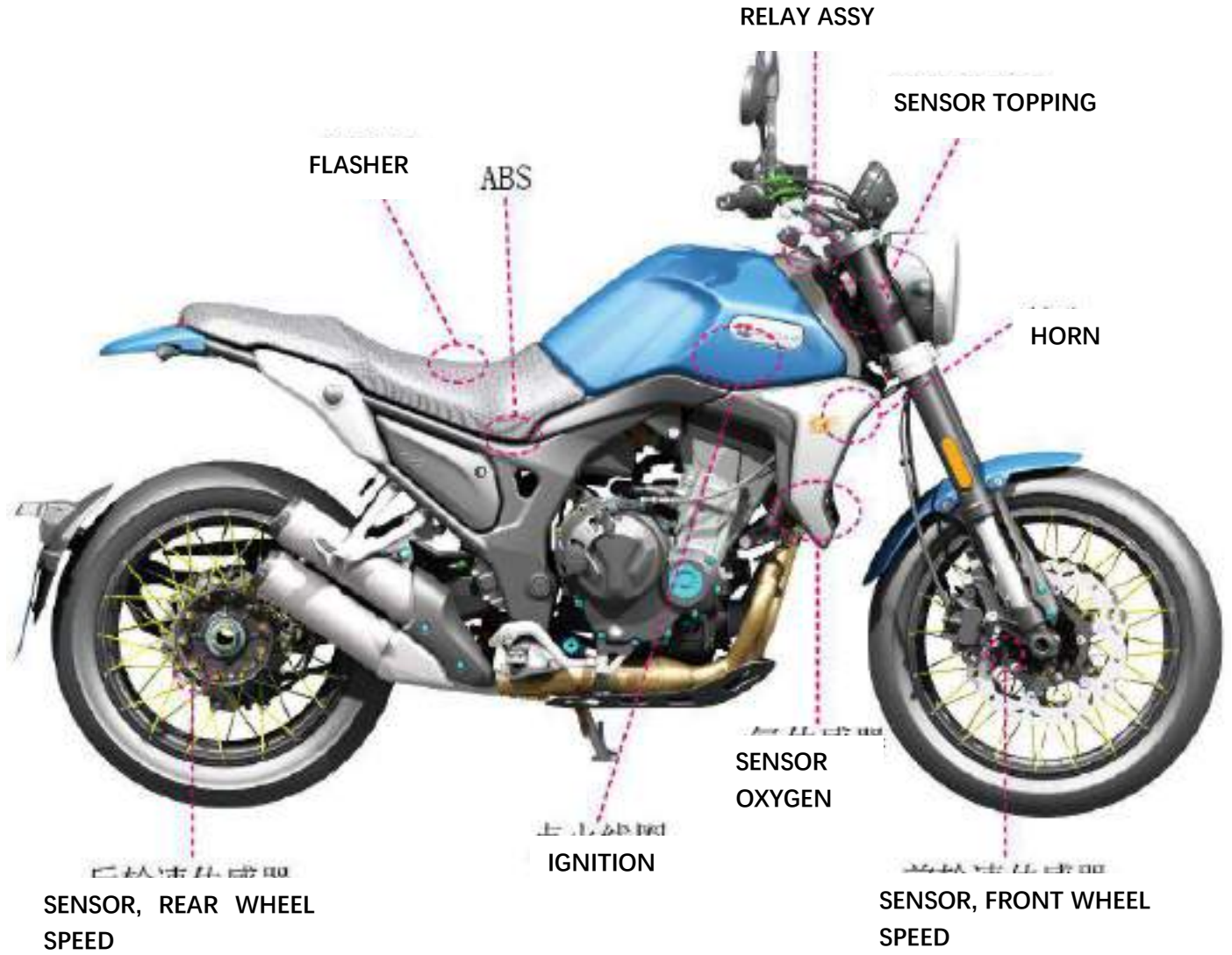

EFI SYSTEM MAINTENANCE INSTRUCTIONS

1) General maintenance instructions

Only the digital multimeter is allowed to check the EFI system.

Please use genuine parts for maintenance, otherwise the normal operation of the EFI system cannot be guaranteed.

Only unleaded gasoline can be used during maintenance.

Please follow the normal maintenance and diagnosis procedures for maintenance operations.

It is forbidden to disassemble and disassemble the parts of the EFI system during maintenance.

During maintenance, when handling electronic components (electronic control units, sensors, etc.), be very careful not to let them fall to the ground.

Establish the awareness of environmental protection and effectively dispose of the waste generated in the maintenance process.

2) Matters needing attention during maintenance

- Do not arbitrarily remove any parts or connectors of the EFI system from its installation position, so as to avoid accidental damage or foreign objects such as water and oil entering the connectors, which will affect the normal operation of the EFI system.

- When disconnecting and connecting the connectors, be sure to place the ignition switch in the off position, otherwise electrical components will be damaged.

- Never make the temperature of the electronic control unit exceed 80° C when performing faulty thermal condition simulation and other maintenance operations that may increase the temperature.

- The fuel supply pressure of the EFI system is relatively high (about 300kPa), and all fuel lines are high-pressure resistant fuel pipes. Even if the engine is not running, high fuel pressure is maintained in the oil circuit. Therefore, be careful not to disassemble the fuel pipe easily during the maintenance process. When the fuel system needs to be repaired, the fuel system should be depressurized before disassembling the fuel pipe. The pressure relief method is as follows: Remove the fuel pump relay and start the engine to idle. Run until the engine goes out by itself. Removal of fuel pipe and fuel filter Replacement should be performed by professional maintenance personnel in a well-ventilated place.

- When removing the electric fuel pump from the fuel tank, do not energize the fuel pump to avoid electric sparks and fire.

- The fuel pump is not allowed to run the test in dry state or in water, otherwise its service life will be shortened. In addition, the positive and negative poles of the fuel pump must not be reversed.

- When inspecting the ignition system, perform spark jump detection only when necessary, and the time should be as short as possible, and the throttle cannot be opened during the detection, otherwise it will cause a large amount of unburned gasoline to enter the exhaust pipe and damage the three-way catalyst Device.

- Since the adjustment of the idle speed is completely completed by the electronic injection system, no manual adjustment is required. The throttle limit screw of the throttle body has been adjusted when the manufacturer leaves the factory, and the user is not allowed to change its initial position at will.

When connecting the battery, the positive and negative poles of the battery should not be connected wrongly, so as not to damage the electronic components. This system adopts negative ground.

- When the engine is running, it is not allowed to remove the battery cable.

Before performing electric welding on the car, the positive and negative cables of the battery and the electronic control unit must be disconnected.

- Do not use the method of piercing the skin of the wire to detect the electrical signal input and output of the component.

3) List of maintenance tools



Tool name :

EFI system diagnostic instrument

function :

Reading/clearing fault codes of EFI system, observing data flow, component action test,



Tool name:

Efi system adapter

Features:

Check the electrical signal of each pin of the electronic control unit, check the wiring condition,



Tool name :
Ignition timing light
function :
Check engine ignition timing, etc.



Tool name :
Digital multimeter
function :
Check the voltage, current, resistance and



Tool name :
Vacuum gauge
function :
Check the pressure in the intake manifold.



Tool name :
Cylinder pressure gauge
function :
Check the cylinder pressure of each cylinder.



Tool name :
Fuel pressure gauge
function :
Check the pressure in the intake manifold.

INTRODUCTION TO SYSTEM FAULT DIAGNOSIS

On-board diagnostic system (abbreviated as OBD system) refers to a diagnostic system that is integrated in the engine control system and can monitor faulty components that affect exhaust emissions and the status of the engine's main functions. It has the function of identifying, storing and displaying fault information through the self-diagnostic fault indicator (MIL).

When repairing a vehicle with an OBD system, the maintenance personnel can quickly and accurately locate the faulty component through the diagnostic instrument, which greatly improves the efficiency and quality of the repair.

OBD technology involves many new concepts. The following first introduces some basic knowledge related to OBD technology to facilitate a better understanding of the subsequent content.

1) Fault information record

The electronic control unit continuously monitors sensors, actuators, related circuits, fault indicators, battery voltage, etc., and even the electronic control unit itself, and monitors sensor output signals, actuator drive signals, and internal signals (such as closed-loop control, Coolant temperature, idling speed control and battery voltage control, etc.) for reliability testing. Once a fault is found in a certain link, or a certain signal value is unreliable, the electronic control unit immediately sets a fault information record in the fault memory of the RAM. The fault information records are stored in the form of fault codes and displayed in the order of occurrence of the faults.

Faults can be divided into "steady-state faults" and "incidental faults" according to their frequency of occurrence (for example, caused by short-term wiring harness disconnection or poor contact of connectors).

Schematic diagram of fault diagnosis of EFI system

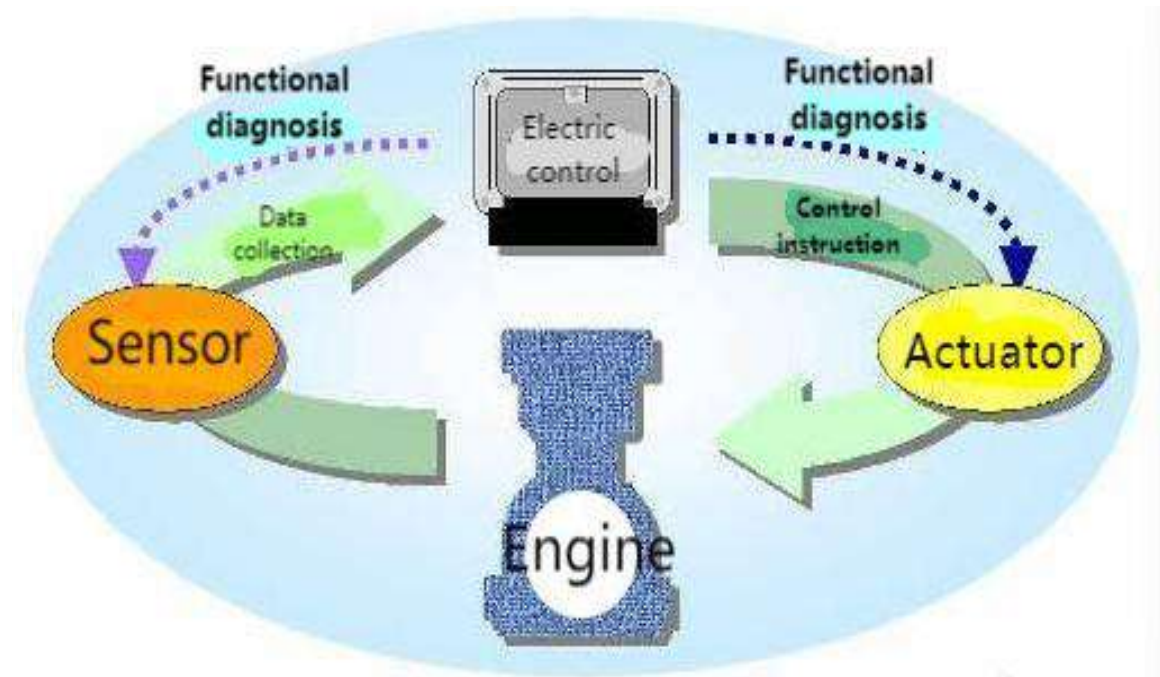

2) Description of fault light and its control strategy

Fault indicator (MI): It is used to indicate when emission-related components or systems fail. MI is generally an indicator light that can be displayed on the dashboard and whose shape meets the requirements of regulations and standards.

The activation of MIL lights follows the following principles:

1) In normal mode, and the fault memory is empty

Turn on the ignition switch, and the ECU will be initialized immediately. From initialization, the MIL light is on for 4 seconds. If you start (start the car) within these 4 seconds, the MIL will go out immediately after the engine speed is found.

2) In normal mode, and the faulty memory has failed

From the initialization of the ignition ECU, the MIL light keeps on until the engine speed is found. If the fault manager requires the MIL to light up in the fault mode, the MIL light will light up in the subsequent driving cycle; if the fault manager does not require the MIL to light up in the fault mode, the MIL light will go out after finding the engine speed.

3) Troubleshooting steps

For vehicles with OBD function, troubleshooting generally follows the following steps:

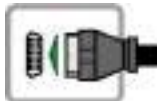

1. Connect the diagnostic test equipment to the diagnostic interface, and switch on the diagnostic test equipment.

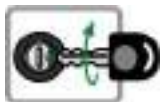

2. Turn on the "ignition switch" .



3. Read fault-related information (fault codes, freeze frames, etc.); check the maintenance manual to confirm the faulty parts and types; make maintenance plans based on fault-related information and experience.



4. Troubleshoot the fault.



5. Clear the fault memory; run the vehicle properly, and the operation mode must meet the conditions of the corresponding fault diagnosis; read the fault information and confirm that the fault has been eliminated.

Generally, the standard connector is equipped on the wiring harness of the whole vehicle, and the corresponding connector of the diagnostic instrument can be directly plugged in.

(1) Version information display

Engine information, ECU hardware number, ECU software number.

(2) Fault display

Intake air pressure sensor, intake air temperature sensor, engine temperature sensor, throttle position sensor, oxygen sensor, oxygen sensor heating circuit, air-fuel ratio correction, fuel injector, fuel pump relay, speed sensor, carbon canister control valve, vehicle speed signal, Idle speed, idle speed regulator, system voltage, ECU, fault light.

(3) Engine parameter display

Battery voltage, engine speed, target idling speed, vehicle speed, engine temperature, engine temperature sensor signal voltage, intake air temperature, intake air temperature sensor signal voltage, intake pressure, intake air volume, stepper motor target position, throttle position sensor signal Voltage, throttle opening, relative throttle position, canister control valve duty ratio, charging time, fuel injection pulse width, ignition advance angle, oxygen sensor short-term correction, oxygen sensor voltage, oxygen sensor long-term correction, relative engine load, The canister controls relative fuel injection volume, canister purification rate, canister load, idling actuator TEV opening, ambient pressure, altitude correction factor, fuel injection phase, and running time.

(4) EFI system status display

The ignition terminal is turned on, the main relay is working, the fuel pump relay is working, the idling speed is reached, the engine operating temperature is reached, the vehicle is running, the idling condition, the full load condition, the activation of deceleration and depletion, the activation of acceleration and enrichment, the activation of fuel injection closed-loop control , Decelerate and cut off oil activation, lambda control activation, canister control valve activation, mixed gas self-learning condition activation, fault indicator status, MIL flashing.

(5) Test function of actuator

Fault light, fuel pump, stepper motor, carbon canister control valve, ignition, fuel injection.

(6) Description of project-related issues:

System Features:

- Sequential injection system;
- New modular software structure and hardware structure, strong portability;
- Use 36-2 tooth signal disc to identify the speed signal;
- Idle speed control with bypass air passage (solenoid valve idle speed regulator or stepper motor);
- Realize closed-loop control of idle speed;
- Has the function of heating the catalytic converter;
- Has the function of limp going home;

SYSTEM FAULT DIAGNOSIS

The MSE6.0 system performs maintenance and diagnosis process based on the fault code

Description:

1. The following maintenance should be carried out only after the current steady-state fault has been confirmed, otherwise it will lead to a diagnosis error.
2. The “multimeter” mentioned below refers to the digital multimeter. It is prohibited to use the pointer

type multimeter to check the circuit of the EFI system.

3. Check and repair vehicles with anti-theft system. If the ECU is replaced in the "Next Steps" column, pay attention to programming the ECU after replacement.

4. If the fault code indicates that the voltage of a certain circuit is too low, it means that the circuit may be short-circuited or open; if the fault code indicates that the voltage of a certain circuit is too high, it means that the circuit may be short-circuited to the power supply; If the fault code indicates a circuit failure, it means that there may be an open circuit or multiple circuit failures in the circuit. Diagnosis help:

1. The fault code cannot be cleared, and the fault is a steady-state fault; if it is an occasional fault, check whether the wiring harness connector is loose.
2. It has been checked according to the above steps, and no abnormality has been found.
3. Do not neglect the influence of vehicle maintenance, cylinder pressure, mechanical timing, etc. on the system during the overhaul.
4. Replace ECU and test.

If the fault code can be cleared at this time, the fault location is in the ECU. If the fault code still cannot be cleared at this time, replace the original ECU, repeat the process, and perform maintenance work again.

The following are the meanings of the fault codes used in the current MSE6.0 system, the corresponding diagnosis strategies and possible fault causes, as well as the troubleshooting strategies, which can be referred to in the vehicle maintenance process.

The related ECU pins mentioned below are subject to the actual wiring harness diagram of the project.
error code:P0030 Oxygen sensor heating control circuit is open

<p>Repair tips: The fault has been confirmed and the following problems may exist</p> <ol style="list-style-type: none"> 1) There is an open circuit between the circuit connected to the ECU pin and the upstream oxygen sensor No. 2 pin. 2) The circuit connecting the No. 1 pin of the upstream oxygen sensor to the main relay is open. 3) Open circuit between No. 1 and No. 2 pins of the upstream oxygen sensor. 	<p>Repair tips: Check the following items</p> <ol style="list-style-type: none"> 1) Measure the resistance of the circuit between the ECU connector pin and the upstream oxygen sensor pin 2 to determine whether it is normal. 2) Measure the resistance between pin 1 of the upstream oxygen sensor and the main relay to determine whether it is normal 3) Measure the resistance between pin 1 and pin 2 of the upstream oxygen sensor to determine whether it is normal
---------------------------------------------------------------------------------------------------------------------------------------------------------------------------------------------------------------------------------------------------------------------------------------------------------------------------------------------------------------------------------------------------------------------------------------------------------------	-------------------------------------------------------------------------------------------------------------------------------------------------------------------------------------------------------------------------------------------------------------------------------------------------------------------------------------------------------------------------------------------------------------------------------------------------------------------------------------------------------------------

error code:P0031 Oxygen sensor heating circuit is shorted to ground

<p>Repair tips: The fault has been confirmed and the following problems may exist</p> <ol style="list-style-type: none"> 1) The circuit connected to the ECU pin is short-circuited to ground 	<p>Repair tips: Check the following items</p> <ol style="list-style-type: none"> 1) Measure whether the ground resistance of the ECU pin is normal
------------------------------------------------------------------------------------------------------------------------------------------------------------------------------------------------------------------	-----------------------------------------------------------------------------------------------------------------------------------------------------------------------

error code:P0032 Oxygen sensor heating circuit is shorted to the power supply

Repair tips: The fault has been confirmed and the following	Repair tips: Check the following items
Repair tips: 故障已经被确认可能存在以下问题 1) 连接到 ECU 脚的电路与上游氧传感器 1 号脚电路之间短路。 2) 连接到 ECU 脚的电路与 others 电源电路之间短路。	Repair tips: 检查以下项目 1) 测量 ECU 电压是否正常。 2) 测量 ECU 脚与上游氧传感器 1 号脚电路之间的电阻。
circuit connected to the ECU pin and other power circuits.	

error code: P0053 Oxygen sensor heating internal resistance is unreasonable

Diagnostic instructions for oxygen sensor heater:The system recognizes whether the heating output is correct by measuring the heating resistance value of the sensor. Heated sensors can be damaged by condensate under certain unfavorable conditions, especially during the cold start phase.

Repair tips: The fault has been confirmed and the following problems may exist 1) The heating function of the upstream oxygen sensor fails. Replace the oxygen sensor.	Repair tips:
------------------------------------------------------------------------------------------------------------------------------------------------------------------------------	--------------

error code: P0105 No change in intake air pressure sensor signal

<p>Repair tips: The fault has been confirmed and the following problems may exist</p> <ol style="list-style-type: none"> 1) The intake air pressure sensor is frozen or blocked. 2) The intake pressure sensor is seriously aging. 	<p>Repair tips: Check the following items</p> <ol style="list-style-type: none"> 1) Reinstall after melting the ice in the sensor at room temperature.
----------------------------------------------------------------------------------------------------------------------------------------------------------------------------------------------------------------------------------------------------------------	---------------------------------------------------------------------------------------------------------------------------------------------------------------------------

error code: P0106 Intake pressure sensor signal is unreasonable fault

<p>Repair tips: The fault has been confirmed and the following problems may exist</p> <ol style="list-style-type: none"> 1) The sensing element in the pressure sensor is leaking 2) The pressure sensor is damaged 3) Air leakage at the installation position of the pressure sensor 4) Pressure sensor characteristic deviation 	<p>Repair tips:</p>
----------------------------------------------------------------------------------------------------------------------------------------------------------------------------------------------------------------------------------------------------------------------------------------------------------------------------------------------------------------------------------	---------------------

error code: P0107 Intake air pressure sensor circuit voltage is too low

<p>Repair tips: The fault has been confirmed and the following problems may exist</p> <ol style="list-style-type: none"> 1) ECU detects that the sensor signal circuit is shorted to ground 	<p>Repair tips: Check the following items</p> <ol style="list-style-type: none"> 1) Resistance between ECU pin and ground
----------------------------------------------------------------------------------------------------------------------------------------------------------------------------------------------------------------	----------------------------------------------------------------------------------------------------------------------------------------------

error code: P0108 Intake pressure sensor circuit voltage is too high

<p>Repair tips: The fault has been confirmed and the following problems may exist</p> <ol style="list-style-type: none"> 1) ECU detects that the sensor signal circuit is short-circuited to the power supply 	<p>Repair tips: Check the following items</p> <ol style="list-style-type: none"> 1) Voltage of ECU pin
----------------------------------------------------------------------------------------------------------------------------------------------------------------------------------------------------------------------------------	---------------------------------------------------------------------------------------------------------------------------

error code: P0112 Intake air temperature sensor signal voltage is too low

<p>Repair tips:</p> <p>The fault has been confirmed and the following problems may exist</p> <ol style="list-style-type: none">1) The sensor signal circuit connected to the ECU pin is short-circuited to ground	<p>Repair tips:</p> <p>Check the following items</p> <ol style="list-style-type: none">1) Measure the resistance between the sensor signal circuit of the ECU pin and the ground
---------------------------------------------------------------------------------------------------------------------------------------------------------------------------------------------------------------------------------	------------------------------------------------------------------------------------------------------------------------------------------------------------------------------------------------

error code: P0113 Intake air temperature sensor signal voltage is too high

<p>Repair tips: The fault has been confirmed and the following problems may exist</p> <p>1) The sensor signal circuit connected to the ECU pin is short-circuited to the power supply</p>	<p>Repair tips: Check the following items</p> <p>1) Measure whether the voltage of the sensor signal circuit of the ECU pin is normal</p>
-----------------------------------------------------------------------------------------------------------------------------------------------------------------------------------------------	-----------------------------------------------------------------------------------------------------------------------------------------------

error code: P0116 Engine temperature sensor indicates unreasonable temperature fault

<p>Repair tips: The fault has been confirmed and the following problems may exist</p> <p>1) The water temperature sensor is damaged and needs to be replaced</p>	<p>Repair tips:</p>
----------------------------------------------------------------------------------------------------------------------------------------------------------------------	---------------------

error code: P0117 Engine coolant temperature sensor circuit voltage is too low

<p>Repair tips: The fault has been confirmed and the following problems may exist</p> <p>1) There is a short circuit between the circuit connected to the ECU pin and the ground</p>	<p>Repair tips: Check the following items</p> <p>1) Measure the resistance between the ECU pin and ground.</p>
------------------------------------------------------------------------------------------------------------------------------------------------------------------------------------------	--------------------------------------------------------------------------------------------------------------------

error code: P0118 Engine temperature sensor circuit voltage is too high

<p>Repair tips: The fault has been confirmed and the following problems may exist</p> <p>1) Short circuit between the circuit connected to the ECU pin and other power circuits</p>	<p>Repair tips: Check the following items</p> <p>1) Measure whether the voltage connected to the ECU pin is normal</p>
-----------------------------------------------------------------------------------------------------------------------------------------------------------------------------------------	----------------------------------------------------------------------------------------------------------------------------

error code: P0122 Throttle position sensor circuit voltage limit is too low

<p>Repair tips: The fault has been confirmed and the following problems may exist</p> <p>1) ECU pin is shorted to ground</p>	<p>Repair tips: Check the following items</p> <p>1) Measure the resistance between the ECU pin and the ground</p>
----------------------------------------------------------------------------------------------------------------------------------	-----------------------------------------------------------------------------------------------------------------------

error code: P0123 Throttle position sensor circuit voltage limit is too high

<p>Repair tips: The fault has been confirmed and the following problems may exist</p> <ol style="list-style-type: none">1) Short circuit between the circuit connected to the ECU pin and other power circuits	<p>Repair tips: Check the following items</p> <ol style="list-style-type: none">1) Measure whether the voltage connected to the ECU pin is normal
----------------------------------------------------------------------------------------------------------------------------------------------------------------------------------------------------------------------------------	---------------------------------------------------------------------------------------------------------------------------------------------------------------------

error code: P0130 Oxygen sensor signal is unreasonable fault

Introduction to the cause of the failure:When the oxygen sensor signal appears in the following situations, the system judges that the oxygen sensor signal is unreasonable. The oxygen sensor signal circuit is coupled with the heating circuit.

<p>Repair tips: The fault has been confirmed and the following problems may exist</p> <ol style="list-style-type: none">1) Check whether the oxygen sensor connector is correct and normal2) Check whether the oxygen sensor signal circuit and heating circuit are coupled	<p>Repair tips:</p>
--------------------------------------------------------------------------------------------------------------------------------------------------------------------------------------------------------------------------------------------------------------------------------------------------------	---------------------

error code: P0131 Oxygen sensor circuit voltage is too low

<p>Repair tips: The fault has been confirmed and the following problems may exist</p> <ol style="list-style-type: none"> 1) The signal circuit connected to the ECU pin is short-circuited to ground 	<p>Repair tips: Check the following items</p> <ol style="list-style-type: none"> 1) Measure the resistance between the signal circuit connected to the ECU pin and the ground
-------------------------------------------------------------------------------------------------------------------------------------------------------------------------------------------------------------------------	--------------------------------------------------------------------------------------------------------------------------------------------------------------------------------------------------

error code: P0132 Oxygen sensor circuit voltage is too high

Introduction to the cause of the failure:When the engine starts, the ECU measures the voltage of the oxygen sensor circuit. When the signal voltage is higher than 1.5V for a long time, it is judged that the oxygen sensor signal circuit is short-circuited to the power supply.

<p>Repair tips: The fault has been confirmed and the following problems may exist</p> <ol style="list-style-type: none"> 1) There is a short circuit between the signal circuit connected to the ECU pin and the oxygen sensor pin 1 2) Short circuit between the signal circuit connected to the ECU pin and other power circuits 	<p>Repair tips: Check the following items</p> <ol style="list-style-type: none"> 1) Measure the resistance between the signal circuit connected to the ECU pin and the oxygen sensor pin 1 2) Measure the voltage of the signal circuit connected to the ECU pin
----------------------------------------------------------------------------------------------------------------------------------------------------------------------------------------------------------------------------------------------------------------------------------------------------------------------------------------------------------------	----------------------------------------------------------------------------------------------------------------------------------------------------------------------------------------------------------------------------------------------------------------------------------------------

error code: P0133 Oxygen sensor aging

Introduction to the cause of the failure:Under normal circumstances, the air-fuel ratio of the air-fuel mixture is switched between rich and lean. Correspondingly, the oxygen sensor signal will be shown as continuous fluctuations in the signal amplitude. When the oxygen sensor ages, the sensitivity of the mixture will decrease. This will be manifested as a slower signal fluctuation period. The ECU will calculate the average period of the signal according to the corresponding algorithm. If it is found to be slower than the pre-set critical value, It is judged that the sensor is aging.

<p>Repair tips: The fault has been confirmed and the following problems may exist</p> <ol style="list-style-type: none"> 1) The sensor is aging and needs to be replaced 	<p>Repair tips:</p>
---------------------------------------------------------------------------------------------------------------------------------------------------------------------------------------------	---------------------

error code: P0134 Oxygen sensor signal failure

Introduction to the cause of the failure: When the engine starts, the ECU measures the voltage of the oxygen sensor circuit. When the signal voltage always changes between 0.4 ~0.6 volts, the system judges that the oxygen sensor signal circuit is open-circuited.

<p>Repair tips: The fault has been confirmed and the following problems may exist</p> <ol style="list-style-type: none">1) The circuit connecting the oxygen sensor to the ECU pin is open2) Poor connection of oxygen sensor connector (pin oxidation)	<p>Repair tips: Check the following items</p> <ol style="list-style-type: none">1) Measure the resistance from the ECU connector to the oxygen sensor No. 4
------------------------------------------------------------------------------------------------------------------------------------------------------------------------------------------------------------------------------------------------------------------------------------	-------------------------------------------------------------------------------------------------------------------------------------------------------------------------------

error code: P0170 Offline detection air-fuel ratio closed-loop control self-learning is unreasonable.

error code: P0171 Offline detection air-fuel ratio is too thinner than closed-loop control self-learning.

error code: P0172 Offline detection air-fuel ratio is too thick for closed-loop control self-learning.

(Note: The maintenance process is applicable to the failure codes of the intake pressure sensor, carbon canister control valve, oxygen sensor, etc., which do not occur at the same time. If the related failure codes exist at the same time, please handle other failures first, and then check whether the oil circuit is normal.)

error code: P0201 One-cylinder injector control circuit is open.

error code: P0202 Two-cylinder injector control circuit is open.

<p>Repair tips: The fault has been confirmed and the following problems may exist</p> <ol style="list-style-type: none"> 1) Is the injector coil open 2) Whether the connection between the injector connector pins and the U ECU pin is good 3) Whether the connection between the injector connector pins and the main relay is good 	<p>Repair tips: Check the following items</p>
-----------------------------------------------------------------------------------------------------------------------------------------------------------------------------------------------------------------------------------------------------------------------------------------------------------------------------------------------------------------------------	---------------------------------------------------

error code: P0261 One-cylinder injector control circuit is shorted to ground

error code: P0264 Two-cylinder injector control circuit is shorted to ground

<p>Repair tips: The fault has been confirmed and the following problems may exist</p> <ol style="list-style-type: none"> 1) Each drive circuit connected to the ECU pin is short-circuited to ground 	<p>Repair tips: Check the following items</p> <ol style="list-style-type: none"> 1) Measure the resistance of the circuit connected to the ECU pin to ground
-------------------------------------------------------------------------------------------------------------------------------------------------------------------------------------------------------------------------	---------------------------------------------------------------------------------------------------------------------------------------------------------------------------------

error code: P0262 One-cylinder injector control circuit is short-circuited to the power supply

error code: P0265 Two-cylinder injector control circuit is short-circuited to the power supply

<p>Repair tips: The fault has been confirmed and the following problems may exist</p> <ol style="list-style-type: none"> 1) The circuit connected to the ECU pin is short-circuited with other power sources 	<p>Repair tips: Check the following items</p> <ol style="list-style-type: none"> 1) Measure the voltage of the circuit connected to the ECU pin
---------------------------------------------------------------------------------------------------------------------------------------------------------------------------------------------------------------------------------	--------------------------------------------------------------------------------------------------------------------------------------------------------------------

error code: P0321 Speed sensor reference point failure

Introduction to the cause of the failure: The system adopts a 36-2 tooth speed measurement system. The 36-2 induction ring gear is installed on the flywheel. As the flywheel (rotating speed is the same as the crankshaft), it will produce magnetic changes in the sensor, thereby generating an induced AC voltage, whose frequency depends on Rotating speed. The ECU signal circuit converts the input sine wave into a square wave. When the ECU finds that the distance between the falling edges of two square waves is greater than the two tooth spacing, the reference position is found. Physically the reference tooth pitch corresponds to a specific position of a cylinder. The system defines the software reference point signal (BM) at the

second falling edge after the reference tooth pitch, and the crankshaft angle between the software reference point signal and the top dead center of a cylinder is The fixed value is 100° CA. Therefore, every time the crankshaft rotates, the system will receive a software reference point signal, and according to this software reference point signal, the system keeps "synchronized" with the crankshaft position, thereby ensuring the correct control of fuel injection, air intake and ignition timing .

If one of the following conditions is found, it is judged that the crankshaft software reference point signal (BM) is faulty:

1. Frequently find that the measured crankshaft software reference point signal (BM) is ahead or lagging behind the expected position;
2. The speed signal can be detected but the crankshaft software reference point signal (BM) is not detected;
3. Frequent loss of crankshaft software reference point signal (BM).

<p>Repair tips: The fault has been confirmed and the following problems may exist</p> <ol style="list-style-type: none"> 1) Intermittent short circuit or open circuit connection 2) Installation position deviation of crankshaft signal wheel 3) The installation position deviation of the speed sensor 	<p>Repair tips:</p>
-------------------------------------------------------------------------------------------------------------------------------------------------------------------------------------------------------------------------------------------------------------------------------------------------------------------------------------------------	---------------------

error code: P0322 No speed sensor pulse signal (open circuit or short circuit)

Introduction to the cause of the failure: When the engine is started, the ECU simultaneously monitors the speed sensor signal and other signals.

The system judges that the signal of the speed sensor is lost through the rationality of the signal.

<p>Repair tips: The fault has been confirmed and the following problems may exist</p> <ol style="list-style-type: none"> 1) The circuit connecting the speed sensor to the ECU is open 2) The circuit connecting the speed sensor to the ECU is short-circuited 	<p>Repair tips:</p>
---------------------------------------------------------------------------------------------------------------------------------------------------------------------------------------------------------------------------------------------------------------------------------------------	---------------------

error code: P0444 Canister control valve control circuit is open

<p>Repair tips: The fault has been confirmed and the following problems may exist</p> <ol style="list-style-type: none"> 1) There is an open circuit between the circuit connected to the ECU and the No. 2 pin of the canister control valve. 2) The circuit connecting pin 1 of the canister control valve to the main relay is open 3) The solenoid between pin 1 and pin 2 of the canister control valve is open 	<p>Repair tips:</p>
-----------------------------------------------------------------------------------------------------------------------------------------------------------------------------------------------------------------------------------------------------------------------------------------------------------------------------------------------------------------------------------------------------------------------------------------------------------	---------------------

error code: P0458 Canister control valve control circuit voltage is too low

<p>Repair tips: The fault has been confirmed and the following problems may exist</p> <ol style="list-style-type: none"> 1) The circuit connected to the ECU is short-circuited to ground 	<p>Repair tips: Check the following items</p> <ol style="list-style-type: none"> 1) Measure whether the resistance to ground connected to the ECU pin is normal
--------------------------------------------------------------------------------------------------------------------------------------------------------------------------------------------------------------	------------------------------------------------------------------------------------------------------------------------------------------------------------------------------------

error code: P0459 Canister control valve control circuit voltage is too high

<p>Repair tips: The fault has been confirmed and the following problems may exist</p> <ol style="list-style-type: none"> 1) There is a short circuit between the circuit connected to the ECU and the circuit of pin 1 of the carbon canister control valve 2) There is a short circuit between the circuit connected to the ECU pin and other power circuits 	<p>Repair tips: Check the following items</p> <ol style="list-style-type: none"> 1) Measure whether the voltage of ECU pin is normal. 2) Measure the resistance between the ECU pin and the No. 1 pin circuit of the carbon canister control valve
-------------------------------------------------------------------------------------------------------------------------------------------------------------------------------------------------------------------------------------------------------------------------------------------------------------------------------------------------------------------------------------------	--------------------------------------------------------------------------------------------------------------------------------------------------------------------------------------------------------------------------------------------------------------------------------

error code: P0501 The signal of the vehicle speed sensor is unreasonable

Introduction to the cause of the failure:When the vehicle is coasting while releasing the throttle, the ECU will monitor the engine speed and vehicle speed at the same time. If the engine is maintained at a higher speed but the vehicle speed is displayed as 0 or obviously too low, the system will determine that the vehicle speed signal is faulty.

<p>Repair tips: The fault has been confirmed and the following problems may exist</p> <ol style="list-style-type: none"> 1) The signal circuit of the ECU connected to the vehicle speed sensor is short-circuited or open-circuited to the ground 	<p>Repair tips: Check the following items</p> <ol style="list-style-type: none"> 1) Check the circuit resistance of the ECU connector connected to the vehicle speed signal sensor 2) Check the ground resistance of the ECU pin circuit
-----------------------------------------------------------------------------------------------------------------------------------------------------------------------------------------------------------------------------------------------------------------------	----------------------------------------------------------------------------------------------------------------------------------------------------------------------------------------------------------------------------------------------------------------------

error code: P0506 Idle speed control speed is lower than target idle speed

Introduction to the cause of the failure:The engine idling speed is realized through closed-loop control. If the ECU enters the idling speed control for a certain period of time, but the actual engine speed is still lower than the target idling speed a certain value, the fault is judged.

<p>Repair tips: The fault has been confirmed and the following problems may exist</p> <ol style="list-style-type: none"> 1) Stepper motor stuck in a small opening 2) Check whether the throttle adjustment screw, throttle cable, throttle condition, etc. are working well 3) Throttle internal viscera 	<p>Repair tips:</p>
------------------------------------------------------------------------------------------------------------------------------------------------------------------------------------------------------------------------------------------------------------------------------------------------------------------------------------------------	---------------------

error code: P0507 Idle speed control speed is higher than target idle speed

Introduction to the cause of the failure: The engine idling speed is realized by closed-loop control. If the ECU enters the idling speed control for a certain period of time, but the actual engine speed is still higher than the target idling speed by a certain value, it is judged as the fault

Repair tips:

The fault has been confirmed and the following problems may exist

- 1) Check whether the throttle adjustment screw, throttle cable, and throttle operating conditions are in good working order
- 2) Throttle internal viscera
- 3) Stepper motor stuck in larger opening
- 4) Stepper motor stuck in larger opening

Repair tips:

error code: P0508 Stepper motor drive pin is shorted to ground

error code: P0509 Stepper motor drive pin is shorted to the power supply

error code: P0511 Stepper motor drive pin is open

Introduction to the cause of the failure: After the engine is started, the circuit control module in the ECU continuously monitors the drive circuit voltage of the idle stepper motor. When any one of the four circuits is short-circuited to ground/shorted to power/open, the system judges it as a stepper motor circuit. Corresponding failure.

<p>Repair tips: The fault has been confirmed and the following problems may exist</p> <ol style="list-style-type: none"> 1) Any one of the drive circuits of the stepping motor connected to the ECU is short-circuited to ground or short-circuited/opened to the power supply 	<p>Repair tips: Check the following items</p> <ol style="list-style-type: none"> 1) Measure the resistance or voltage between each stepping motor drive circuit connected to the ECU and the ground
----------------------------------------------------------------------------------------------------------------------------------------------------------------------------------------------------------------------------------------------------------------------------------------------------	------------------------------------------------------------------------------------------------------------------------------------------------------------------------------------------------------------------------

error code: P0560 system battery voltage signal is unreasonable

error code: P0562 System battery voltage is too low

error code: P0563 System battery voltage is too high

<p>Repair tips: The fault has been confirmed and the following problems may exist</p> <ol style="list-style-type: none"> 1) The generator has been damaged and cannot generate electricity or the battery is leaking 2) Open circuit of generator excitation circuit 3) The generator regulator has been damaged, unable to control the power generation, resulting in too high power generation voltage 	<p>Repair tips: Check the following items</p> <ol style="list-style-type: none"> 1) Measure the resistance or voltage of the oil pump relay control circuit connected to the ECU 2) Resistance from relay to main relay 3) The resistance between the two legs of the relay
-----------------------------------------------------------------------------------------------------------------------------------------------------------------------------------------------------------------------------------------------------------------------------------------------------------------------------------------------------------------------------------------------------------------------------------------------	------------------------------------------------------------------------------------------------------------------------------------------------------------------------------------------------------------------------------------------------------------------------------------------------------------------

error code: P0627 Oil pump relay control circuit is open

error code: P0628 Oil pump relay control circuit is shorted to ground

error code: P0629 Oil pump relay control circuit is shorted to the power supply

<p>Repair tips: The fault has been confirmed and the following problems may exist</p> <ol style="list-style-type: none"> 1) Open circuit/short circuit to ground/short circuit to power supply between oil pump relay control circuit connected to ECU and oil pump relay. 3) Open circuit between relay connected to main relay 3) The solenoid coil of the relay is open 	<p>Repair tips: Check the following items</p> <ol style="list-style-type: none"> 2) Measure the resistance or voltage of the oil pump relay control circuit connected to the ECU 4) Resistance from relay to main relay 3) The resistance between the two legs of the relay
-----------------------------------------------------------------------------------------------------------------------------------------------------------------------------------------------------------------------------------------------------------------------------------------------------------------------------------------------------------------------------------------------------------------	------------------------------------------------------------------------------------------------------------------------------------------------------------------------------------------------------------------------------------------------------------------------------------------------------------------

error code: P0650 MIL lamp driver stage circuit failure

<p>Repair tips: The fault has been confirmed and the following problems may exist</p> <ol style="list-style-type: none">1) The MIL lamp drive circuit connected to the ECU is open/shorted to ground/shorted to power.3) The circuit between the MIL connected to the main relay is open3) MIL lamp burned out	<p>Repair tips: Check the following items</p> <ol style="list-style-type: none">1) Measure the resistance or voltage of the MIL lamp drive circuit connected to the ECU
----------------------------------------------------------------------------------------------------------------------------------------------------------------------------------------------------------------------------------------------------------------------------------------------------------------------------------------------------	-------------------------------------------------------------------------------------------------------------------------------------------------------------------------------------------

error code: P2177 Air-fuel ratio closed-loop control self-learning value exceeds the upper limit

error code: P2178 Air-fuel ratio closed-loop control self-learning value exceeds the lower limit

Introduction to the cause of the failure: In order to optimize the comprehensive conversion efficiency of HC, CO and NO_x by the catalytic converter, the air-fuel ratio of the mixture needs to be controlled at 14.7:1. When the engine parts manufacturing deviation, the glue in the gasoline deposits on the injector, the intake duct or the back of the valve, and the air leakage of the intake and exhaust system, it will cause the air-fuel ratio to deviate from 14.7:1 (lean or rich). Richer will lead to worsening emissions and lower engine performance. The engine control system will correct and self-learn the fuel injection amount according to the degree and characteristics of the deviation of the air-fuel ratio. When the self-learning value reaches the upper limit set by the system (the mixture is leaner or richer, the system continuously corrects the fuel injection volume until the maximum value), the system judges that the self-learning value exceeds the limit.

<p>Repair tips: The fault has been confirmed and the following problems may exist</p> <ol style="list-style-type: none"> 1) The injector is blocked and needs to be cleaned 3) Air leakage in intake and exhaust system 3) Excessive accumulation of glue on the back of the intake duct or intake valve requires cleaning 4) Engine parts deviation 5) Valve clearance deviation 6) Fuel system pressure deviation 	<p>Repair tips:</p>
-------------------------------------------------------------------------------------------------------------------------------------------------------------------------------------------------------------------------------------------------------------------------------------------------------------------------------------------------------------------------------------------------------------------------------------------------------------------------------------	---------------------

MSE6.0 The diagnosis process of the system for maintenance based on the fault phenomenon

Before starting the steps of fault diagnosis based on the engine fault phenomenon, a preliminary inspection should be carried out first:

1. Confirm that the engine fault indicator is working normally;
2. Check with a fault diagnosis instrument to confirm that there is no fault information record;
3. Confirm that the fault phenomenon complained by the car owner exists, and confirm the conditions for the occurrence of the fault.

Then perform visual inspection:

- (1) Check whether there is leakage in the fuel pipeline;
- (2) Check whether the vacuum pipeline is broken or kinked, and whether the connection is correct;
- (3) Check whether the intake pipeline is blocked, leaked, squashed or damaged;
- (4) Check whether the high-voltage line of the ignition system is broken or aging, and whether the ignition sequence is correct;
- (5) Check whether the grounding part of the wiring harness is clean and firm;

(6) Check whether the connectors of the sensors and actuators are loose or have poor contact.

important hint:If the above phenomenon exists, perform maintenance work for the failure phenomenon first, otherwise it will affect Trouble diagnosis and repair work at the back.

Diagnosis help:

1. Confirm that the engine has no fault records;
2. Confirm the existence of the fault phenomenon in the complaint;
3. It has been checked according to the above steps, and no abnormal situation has been found;
4. Don't ignore the impact of car maintenance, cylinder pressure, mechanical timing, fuel condition, etc. on the system during the overhaul;
5. Replace ECU and test.

If the fault phenomenon can be eliminated at this time, the fault location is in the ECU. If the fault phenomenon still exists at this time, replace the original ECU, repeat the process, and perform the maintenance work again.

- When starting, the engine does not rotate or rotates slowly.
- When starting, the engine can be dragged but cannot be started successfully.
- It is difficult to start a hot car.
- It is difficult to start cold cars.
- The speed is normal, and it is difficult to start at any time.
- The starting is normal, but the idling speed is unstable at any time.
- The starting is normal, and the idling speed is unstable during the warm-up process.
- The starting is normal, and the idling speed is unstable after warming up.
- The starting is normal, and the idling speed is unstable or the flame is turned off under partial load (such as turning on the headlights).
- The starting is normal and the idling speed is too high.
- The speed does not go up or the flame is turned off when accelerating.
- Slow response when accelerating.
- Weakness during acceleration, poor performance

(1) (When starting, the engine does not rotate or rotates slowly.

General fault location :

1. Battery;
2. Starter motor;
3. Wire harness or ignition switch;
4. Engine mechanical part

General diagnosis process:

S/N	Steps	Test results	Next steps
1	Use a multimeter to check the voltage between the two terminals of the battery, whether there is about 8-12V when the engine is started.	Yes	Next step
		No	Replace the battery
2	Keep the ignition switch at the starting position. Use a multimeter to check whether the positive terminal of the starter motor has a voltage above 8V.	Yes	Next step
		No	Repair or replace the wiring harness
3	Disassemble the starter motor and check the working condition of the starter motor. Focus on checking whether there is an open circuit or stuck due to poor lubrication	Yes	Repair or replace the starter motor
		No	Next step
4	If the fault occurs only in winter, check whether the resistance of the starter motor is too large due to improper selection of engine lubricating oil	Yes	Change the lubricating oil with the appropriate label
		No	Next step
5	Check whether the internal mechanical resistance of the engine is too large, causing the starter motor to not rotate or rotate slowly.	Yes	Repair the internal resistance of the engine
		No	Repeat the above steps

(2) When starting, the engine can be dragged, but it cannot be started successfully
 General fault location: 1. No oil in the fuel tank; 2. Fuel pump; 3. Speed sensor; 4. Ignition coil; 5. Engine mechanical part

General diagnosis process:

S/N	Steps	Test results	Next steps
1	Connect the fuel pressure gauge (the front end of the fuel inlet pipe of the access point injector), turn on the ignition switch, repeat it several times if necessary, or start the engine, and check whether the fuel pressure is around 300kPa.	Yes	Next steps
		No	Overhaul the oil supply system
2	Connect the EFI system diagnostic instrument, observe the "engine speed" data item, start the engine, and observe whether there is a speed signal output.	Yes	Next steps
		No	Overhaul the speed sensor circuit
3	Pull out the ignition high voltage wire, connect the spark plug, make the spark plug electrode about 5mm away from the engine body, start the engine, and check if there is a blue and white high voltage fire.	Yes	Next steps
		No	Overhaul the ignition system
4	Check the pressure of the engine cylinder and observe whether there is insufficient pressure in the engine cylinder.	Yes	Troubleshoot engine mechanical failure
		No	Next steps
5	Connect the EFI system adapter, turn on the ignition switch, and check whether the power supply of pins 8# and 33# is normal; check whether the grounding of pins 5# and 10# is normal.	Yes	Diagnosis help
		No	Check and repair the corresponding circuit

(3) It is difficult to start a hot car.

General fault locations:

1. The fuel contains water;
2. The fuel pump;
3. The engine temperature sensor;
4. The ignition coil.

General diagnosis process

S/N	Steps	Test results	Next steps
1	Connect the fuel pressure gauge (the access point is the front end of the fuel injector inlet pipe), start the engine, and check whether the fuel pressure is around 300kPa.	Yes	Next steps
		No	Overhaul the oil supply system
2	Pull out the ignition high voltage wire, connect the spark plug, make the spark plug electrode about 5mm away from the engine body, start the engine, and check if there is a blue and white high voltage fire.	Yes	Next steps
		No	Repair the circuit or replace the sensor
3	Pull down the engine temperature sensor connector, start the engine, and observe whether the engine starts successfully at this time. (Or connect a 300 ohm resistor in series with the engine temperature sensor connector to replace the engine temperature sensor, and observe whether the engine starts successfully at this time.)	Yes	Next steps
		No	Overhaul the ignition system
4	Check the fuel condition and observe whether the malfunction is caused by just after refueling	Yes	Change fuel
		No	Next steps
5	Connect the EFI system adapter, turn on the ignition switch, and check whether the power supply of pins 8# and 33# is normal; check whether the grounding of pins 5# and 10# is normal.	Yes	Diagnosis help
		No	Check and repair the corresponding circuit

(4) Difficult to start cold car

General fault location:

1. Water in fuel;
2. Fuel pump;
3. Engine temperature sensor;
4. Fuel injector;
5. Ignition coil;
6. Throttle body and idle speed bypass air passage;
7. Engine mechanical part.

General diagnosis process:

S/N	Steps	Test results	Next steps
1	Connect the fuel pressure gauge (the access point is the front end of the fuel injector inlet pipe), start the engine, and check whether the fuel pressure is around 300kPa	Yes	Next steps
		No	Overhaul the oil supply system
2	Pull out the ignition high-voltage wire, connect the spark plug, make the spark plug electrode about 5mm away from the engine body, start the engine, and check if there is a blue and white high-voltage fire.	Yes	Next steps
		No	Overhaul the ignition system
3	Pull down the engine temperature sensor connector, start the engine, and observe whether the engine starts successfully at this time. (Or connect a 2500 ohm resistor in series with the engine temperature sensor connector to replace the engine temperature sensor, and observe whether the engine starts successfully at this time.)	Yes	Repair the circuit or replace the sensor
		No	Next steps
4	Gently pull the throttle to observe whether it is easy to start.	Yes	Clean the throttle and idle airway
		No	Next steps
5	Disassemble the fuel injector and check whether the fuel injector is leaking or blocked with a special cleaning analyzer for the fuel injector.	Yes	Replacement of failure
		否	Next steps
6	Check the fuel condition and observe whether the malfunction is caused by just after refueling	Yes	Change fuel
		No	Next steps
7	Check the pressure of the engine cylinder and observe whether there is insufficient pressure in the engine cylinder.	Yes	Troubleshoot engine mechanical failure
		No	Next steps
8	Connect the EFI system adapter, turn on the ignition switch, check whether the power supply of pins 8#, 33# is normal; check whether the grounding of pins 5#, 10# is normal	Yes	Diagnosis help
		No	Check and repair the corresponding circuit

(5) The speed is normal, and it is difficult to start at any time

General fault location:1. Water content in fuel; 2. Fuel pump; 3. Engine temperature sensor;

General fault location:1. Water content in fuel; 2. Fuel pump; 3. Engine temperature sensor;

4. Injector; 5. Ignition coil; 6. Throttle body and idle bypass air passage; 7. Intake port;

8. Ignition timing; 9. Spark plug; 10. Engine mechanical part.

General diagnosis process:

S/N	Steps	Test results	Next steps
1	Check whether the air filter is clogged, and whether there is air leakage in the air inlet.	Yes	Overhaul the intake system
		No	Next steps
2	Connect the fuel pressure gauge (the access point is the front end of the fuel injector inlet pipe), start the engine, and check whether the fuel pressure is around 300kPa.	Yes	Next steps
		No	Overhaul the oil supply system
3	Pull out the sub-cylinder line of one of the cylinders and connect the spark plug so that the spark plug electrode is about 5mm away from the engine body, start the engine, and check whether there is a blue and white high-pressure fire.	Yes	Next steps
		No	Overhaul the ignition system
4	Check the spark plug of the cylinder to observe whether its model and gap meet the specifications.	Yes	Next steps
		No	Adjust or replace
5	Pull down the engine temperature sensor connector, start the engine, and observe whether the engine starts successfully at this time.	Yes	Repair the circuit or replace the sensor
		No	Next steps
6	Gently pull the throttle to observe whether it is easy to start	Yes	Clean the throttle and idle airway
		No	Next steps
7	Disassemble the fuel injector and check whether the fuel injector is leaking or blocked with a special cleaning analyzer for the fuel injector.	Yes	Replacement of failure
		No	Next steps
8	Disassemble and check the fuel condition, and observe whether the malfunction is caused just after refueling.	Yes	Change fuel
		No	Next steps
9	Check the pressure of the engine cylinder and observe whether there is insufficient pressure in the engine cylinder	YES	Troubleshoot engine mechanical failure
		NO	Next steps
10	Check whether the mechanical ignition timing of the engine meets the specifications	Yes	Next steps
		No	Overhaul ignition timing
11	Connect the EFI system adapter, turn on the ignition switch, and check whether the power supply of pins 8# and 33# is normal; check whether the grounding of pins 5# and 10# is normal.	Yes	Diagnosis help
		No	Check and repair the corresponding circuit

6) The starting is normal, but the idle speed is unstable at any time.

General fault location: 1. Water in fuel; 2. Injector; 3. Spark plug; 4. Throttle body and idle bypass air passage; 5. Intake port; 6. Idle speed regulator; 7. Ignition timing; 8. Spark plug; 9. Engine mechanical part.

General diagnosis process:

S/N	Steps	Test results	Next steps
1	Check whether the air filter is clogged, and whether there is air leakage in the air inlet.	Yes	Overhaul the intake system
		No	Next steps
2	Check whether the idle speed regulator is issued a card.	Yes	Clean or replace
		No	Next steps
3	Check the spark plug of the cylinder to observe whether its model and gap meet the specifications.	Yes	Next steps
		No	Adjust or replace
4	Check the throttle body and idle bypass air passage for carbon deposits.	Yes	Cleaning
		No	Next steps
5	Disassemble the fuel injector and use a special cleaning analyzer for the fuel injector to check whether the fuel injector is leaking, clogged or the flow is out of tolerance.	Yes	Replacement of failure
		No	Next steps
6	Check the fuel condition and observe whether the malfunction is caused by just after refueling.	Yes	Change fuel
		No	Next steps
7	Check the pressure of the engine cylinder and observe whether there is a large difference in the pressure of the engine cylinder.	Yes	Troubleshoot engine mechanical failure
		No	Next steps
8	Check whether the mechanical ignition timing of the engine meets the specifications.	Yes	Next steps
		No	Overhaul ignition timing
9	Connect the EFI system adapter, turn on the ignition switch, and check whether the power supply of pins 8# and 3# is normal; check whether the grounding of pins 5# and 10# is normal.	Yes	Diagnosis help
		No	Check and repair the corresponding circuit

(7)The starting is normal, and the idling speed is unstable during the warm-up process. General fault location:1. Water content in fuel; 2. Engine temperature sensor; 3. Spark plug; 4. Throttle body and idle bypass air passage; 5. Intake passage; 6. Idle speed regulator; 7. Engine mechanical part.

General diagnosis process:

S/N	Steps	Test results	Next steps
1	Check whether the air filter is clogged and whether there is air leakage in the air inlet	Yes	Overhaul the intake system
		No	Next steps
2	Check the spark plug of the cylinder to observe whether its model and gap meet the specifications	Yes	Next steps
		No	Adjust or replace
3	Remove the idle speed regulator, check the throttle body, idle speed regulator and idle speed bypass air passage for carbon deposits	Yes	Cleaning related parts
		No	Next steps
4	Pull down the engine temperature sensor connector, start the engine, and observe whether the engine is idling unstable during the warm-up process	Yes	Repair the circuit or replace the sensor
		No	Next steps
5	Disassemble the fuel injector and use a special cleaning analyzer for the fuel injector to check whether the fuel injector is leaking, clogged or the flow is out of tolerance	Yes	Replacement of failure
		No	Next steps
6	Check the fuel condition and observe whether the malfunction is caused by just after refueling	Yes	Change fuel
		No	Next steps
7	Check the pressure of the engine cylinder and observe whether there is a large difference in the pressure of the engine cylinder.	Yes	Troubleshoot engine mechanical failure
		No	Next steps
8	Connect the EFI system adapter, turn on the ignition switch, check whether the power supply of pins 8#, 33# is normal; check whether the grounding of pins 5#, 10# is normal	Yes	Diagnosis help
		No	Check and repair the corresponding circuit

(8) The starting is normal, and the idle speed is unstable after warming up.
 General fault location: 1. Water content in fuel; 2. Engine temperature sensor; 3. Spark plug;
 4. Throttle body and idle bypass air passage; 5. Intake passage; 6. Idle speed regulator;
 7. Engine mechanical part.

General diagnosis process:

S/N	Steps	Test results	Next steps
1	Check whether the air filter is clogged, and whether there is air leakage in the air inlet.	Yes	Overhaul the intake system
		No	Next steps
2	Check the spark plug and observe whether its model and gap meet the specifications.	Yes	Next steps
		No	Adjust or replace
3	Remove the idle speed regulator, check the throttle body, idle speed regulator and idle speed bypass air passage for carbon deposits.	Yes	Cleaning related parts
		No	Next steps
4	Pull down the engine temperature sensor connector, start the engine, and observe whether the engine is idling unstable during the warm-up process.	Yes	Repair the circuit or replace the sensor
		No	Next steps
5	Disassemble the fuel injector and use a special cleaning analyzer for the fuel injector to check whether the fuel injector is leaking, clogged or the flow is out of tolerance.	Yes	Replacement of failure
		No	Next steps
6	Check the fuel condition and observe whether the malfunction is caused by just after refueling.	Yes	Change fuel
		No	Next steps
7	Check the pressure of the engine cylinder and observe whether there is a large difference in the pressure of the engine cylinder.	Yes	Troubleshoot engine mechanical failure
		No	Next steps
8	Connect the EFI system adapter, turn on the ignition switch, and check whether the power supply of pins 8# and 33# is normal; check whether the grounding of pins 5# and 10# is normal.	Yes	Diagnosis help
		No	Check and repair the corresponding circuit

Efi system

(9) (9The starting is normal, and the idling speed is unstable or the flame is turned off when part of the load (such as turning on the headlights).

General fault location: 1. Idle speed regulator; 2. Fuel injector.

General diagnosis process:

S/N	Steps	Test results	Next steps
1	Remove the idle speed regulator and check the throttle body, idle speed regulator and idle speed bypass air passage for carbon deposits.	Yes	Cleaning related parts
		No	Next steps
2	Observe whether the engine output power increases when the load is turned on, that is, use the electronic injection system diagnostic instrument to observe the changes in the ignition advance angle, the fuel injection pulse width and the intake air volume.	Yes	Go to step 4
		No	Next steps
3	Disassemble the fuel injector and use a special cleaning analyzer for the fuel injector to check whether the fuel injector is leaking, clogged or the flow is out of tolerance.	Yes	Replacement of failure
		No	Next steps
4	Connect the EFI system adapter, turn on the ignition switch, and check whether the power supply of pins 8# and 33# is normal; check whether the grounding of pins 5# and 10# is normal.	Yes	Diagnosis help
		No	Check and repair the corresponding circuit

10) The starting is normal and the idle speed is too high.

General fault location: 1. Throttle body and idle speed bypass air passage; 2. Vacuum tube; 3. Idle speed regulator; 4. Engine temperature sensor; 5. Ignition timing.

General diagnosis process:

S/N	Steps	Test results	Next steps
1	Check if the throttle cable is stuck or too tight	Yes	Adjustment
		No	Next steps
2	Check the air intake system and the connected vacuum pipeline for leaks.	Yes	Overhaul the intake system
		No	Next steps
3	Remove the idle speed regulator and check the throttle body, idle speed regulator and idle speed bypass air passage for carbon deposits.	Yes	Cleaning related parts
		No	Next steps
4	Pull down the engine temperature sensor connector, start the engine, and observe whether the engine idling speed is too high at this time.	Yes	Repair the circuit or replace the sensor
		No	Next steps
5	Check whether the mechanical ignition timing of the engine meets the specifications.	Yes	Next steps
		No	Overhaul ignition timing
6	Connect the EFI system adapter, turn on the ignition switch, and check whether the power supply of pins 8# and 33# is normal; check whether the grounding of pins 5# and 10# is normal.	Yes	Diagnosis help
		No	Check and repair the corresponding circuit

(11) The speed does not go up or the flame is turned off when accelerating.

General fault location: 1. Water content in fuel; 2. Intake pressure sensor and throttle position sensor; 3. Spark plug; 4. Throttle body and idle bypass air passage; 5. Intake passage; 6. Idle speed regulator; 7. Fuel injector; 8. Ignition timing; 9. Exhaust pipe.

General diagnosis process:

S/N	Steps	Test results	Next steps
1	Check if the air filter is clogged.	Yes	Overhaul the intake system
		No	Next steps
2	Connect the fuel pressure gauge (the access point is the front end of the fuel injector inlet pipe), start the engine, and check that the fuel pressure is around 300kPa under idling conditions	Yes	Next steps
		No	Overhaul the oil supply system
3	Check the spark plug of the cylinder to observe whether its model and gap meet the specifications	Yes	Next steps
		No	Adjust or replace
4	Remove the idle speed regulator, check the throttle body, idle speed regulator and idle speed bypass air passage for carbon deposits	Yes	Cleaning related parts
		No	Next steps
5	Check whether the intake pressure sensor, throttle position sensor and their wiring are normal	Yes	Next steps
		No	Repair the circuit or replace the sensor
6	Disassemble the fuel injector and use a special cleaning analyzer for the fuel injector to check whether the fuel injector is leaking or blocked	Yes	Replacement of failure
		No	Next steps
7	Check the fuel condition and observe whether the malfunction is caused by just after refueling	Yes	Change fuel
		No	Next steps
8	Check whether the ignition sequence and timing of the engine meet the specifications	Yes	Next steps
		No	Overhaul ignition timing
9	Check whether the exhaust pipe is smoothly exhausted	Yes	Next steps
		No	Repair or replace exhaust pipe
10	Connect the EFI system adapter, turn on the ignition switch, check whether the power supply of pins 8#, 33# is normal; check whether the grounding of pins 5#, 10# is normal	Yes	Diagnosis help
		No	Check and repair the corresponding circuit

(12) Slow response when accelerating

General fault location: 1. Water content in fuel; 2. Intake pressure sensor and throttle position sensor; 3. Spark plug; 4. Throttle body and idle bypass air passage; 5. Intake passage; 6. Idle speed regulator; 7. Fuel injector; 8. Ignition timing; 9. Exhaust pipe.

General diagnosis process:

S/N	Steps	Test results	Next steps
1	Check if the air filter is clogged	Yes	Overhaul the intake system
		No	Next steps
2	Connect the fuel pressure gauge (the access point is the front end of the fuel injector inlet pipe), start the engine, and check whether the fuel pressure is around 300kPa under idling conditions	Yes	Next steps
		No	Overhaul the oil supply system
3	Check the spark plug of the cylinder to observe whether its model and gap meet the specifications	Yes	Next steps
		No	Adjust or replace
4	Remove the idle speed regulator and check the throttle body, idle speed regulator and idle speed bypass air passage for carbon deposits	Yes	Cleaning related parts
		No	Next steps
5	Check whether the intake pressure sensor, throttle position sensor and their wiring are normal	Yes	Next steps
		No	Repair the circuit or replace the sensor
6	Disassemble the fuel injector and check whether the fuel injector is leaking or blocked with a special cleaning analyzer for the fuel injector	Yes	Replacement of failure
		No	Next steps
7	Check the fuel condition and observe whether the malfunction is caused by just after refueling	Yes	Change fuel
		No	Next steps
8	Check whether the ignition sequence and timing of the engine meet the specifications	Yes	Next steps
		No	Overhaul ignition timing
9	Check whether the exhaust pipe is smoothly exhausted	Yes	Next steps
		No	Repair or replace exhaust pipe
10	Connect the EFI system adapter, turn on the ignition switch, and check whether the power supply of pins 8# and 33# is normal; check whether the grounding of pins 5# and 10# is normal.	Yes	Diagnosis help
		No	Check and repair the corresponding circuit

(13) Weakness during acceleration and poor performance.

General fault location: 1. Water content in fuel; 2. Intake pressure sensor and throttle position sensor; 3. Spark plug; 4. Ignition coil; 5. Throttle body and idle bypass air passage; 6. Intake passage; 7. Idle speed regulator; 8. , Fuel injector; 9. Ignition timing; 10. Exhaust pipe.

General diagnosis process:

S/N	Steps	Test results	Next steps
1	Check whether there are faults such as clutch slippage, low tire pressure, brake drag, and unbalanced tire size.	Yes	repair
		No	Next steps
2	Check if the air filter is clogged.	Yes	Overhaul the intake system
		No	Next steps
3	Connect the fuel pressure gauge (the access point is the front end of the fuel injector inlet pipe), start the engine, and check whether the fuel pressure is around 300kPa under idling conditions.	Yes	Next steps
		No	Overhaul the oil supply system
4	Pull out the ignition high-voltage wire, connect the spark plug, make the spark plug electrode about 5mm away from the engine body, start the engine, and check whether the high-voltage fire intensity is normal.	Yes	Next steps
		No	Overhaul the ignition system
5	Check the spark plug of the cylinder to observe whether its model and gap meet the specifications.	Yes	Next steps
		No	Adjust or replace
6	Remove the idle speed regulator, check the throttle body, idle speed regulator and idle speed bypass air passage for carbon deposits.	Yes	Cleaning related parts
		No	Next steps
7	Check whether the intake pressure sensor, throttle position sensor and their wiring are normal.	Yes	Next steps
		No	Repair the circuit or replace the sensor
8	Disassemble the fuel injector and check whether the fuel injector is leaking or blocked with a special cleaning analyzer for the fuel injector.	Yes	Replacement of failure
		No	Next steps
9	Check the fuel condition and observe whether the malfunction is caused just after refueling.	Yes	Change fuel
		No	Next steps
10	Check whether the mechanical ignition timing of the engine meets the specifications.	Yes	Overhaul ignition timing
		No	Next steps
11	Check whether the exhaust pipe is smoothly exhausted.	Yes	Next steps
		No	Repair or replace exhaust pipe
12	Connect the EFI system adapter, turn on the ignition switch, and check whether the power supply of pins 8# and 33# is normal; check whether the grounding of pins 5# and 10# is normal.	Yes	Diagnosis help
		No	Check and repair the corresponding circuit

annex:

1) List of failure codes (PCODE)

序号	ERRO CODE	Description (UAES)
1	P0030	Oxygen sensor heating control circuit is open
2	P0031	Oxygen sensor heating control circuit is shorted to ground
3	P0032	The oxygen sensor heating control circuit is shorted to the power supply
4	P0053	The internal resistance of the oxygen sensor heating is unreasonable
5	P0105	No change in intake pressure sensor signal (icing)
6	P0106	The intake pressure sensor is unreasonable
7	P0107	Intake pressure sensor is shorted to ground
8	P0108	The intake air pressure sensor is shorted to the power supply
9	P0112	Intake air temperature sensor signal voltage is too low
10	P0113	Intake air temperature sensor signal voltage is too high
11	P0116	Engine temperature sensor is unreasonable
12	P0117	Engine temperature sensor circuit voltage is too low
13	P0118	Engine temperature sensor circuit voltage is too high
14	P0122	Throttle position sensor circuit voltage ultra-low limit
15	P0123	Throttle position sensor circuit voltage limit
16	P0130	The oxygen sensor signal is unreasonable
17	P0131	The oxygen sensor signal circuit voltage is too low
18	P0132	The oxygen sensor signal circuit voltage is too high
19	P0134	Oxygen sensor circuit signal failure
20	P0201	One-cylinder injector control circuit is open
21	P0261	One-cylinder injector control circuit is shorted to ground
22	P0262	One-cylinder injector control circuit is shorted to the power supply
23	P0321	Rotational speed signal reference point failure
24	P0322	No speed sensor pulse signal (open circuit or short circuit)
25	P0444	Canister control valve control circuit is open
26	P0458	Canister control valve control circuit voltage is too low
27	P0459	Canister control valve control circuit voltage is too high
28	P0501	The vehicle speed sensor signal is unreasonable
29	P0506	P0506 Idle speed control speed is lower than target idle speed
30	P0507	Idle speed control speed is higher than target idle speed
31	P0508	Stepper motor drive pin is shorted to ground
32	P0509	The stepper motor drive pin is shorted to the power supply
33	P0511	Stepper motor drive pin is open
34	P0560	The system battery voltage signal is unreasonable
35	P0562	System battery voltage is too low
36	P0563	System battery voltage is too high
37	P0602	Electronic control unit coding failure
38	P0627	Oil pump relay control circuit is open
39	P0628	Oil pump relay control circuit is shorted to ground
40	P0629	The oil pump relay control circuit is shorted to the power supply
41	P0650	MIL lamp driver stage circuit failure
42	P2177	The air-fuel ratio closed-loop control self-learning value exceeds the upper limit
43	P2178	The air-fuel ratio closed-loop control self-learning value exceeds the lower limit
44	P1105	Idle speed actuator TEV is shorted to the power supply
45	P1116	Engine temperature exceeds limit
46	P1117	Idle speed actuator TEV short circuit to ground
47	P1118	Idle speed actuator TEV open circuit
48	P571	Brake switch failure
49	P1136	K line disconnection fault

SERVICE INFORMATION -----5-1

TROUBLESHOOTING ----- 5-2

SYSTEM LOCATION ----- 5-4

IGNITION SYSTEM INSPECTION ----- 5-4

IGNITION COIL ----- 5-8

SERVICE INFORMATION

GENERAL

NOTICE:

- .The ECM may be damaged if dropped. Also if the connector is disconnected when current is flowing, the excessive voltage may damage the module. Always turn off the ignition switch before servicing.
- .Use spark plug of the correct heat range. Using a spark plug with an incorrect heat range can damage the engine.
- .Some electrical components may be damaged if terminals or connectors are connected or disconnected while the ignition switch is turned ON and current is present.
- .A faulty ignition system is often related to poorly connected or corroded connections. Check those connections before proceeding
- .Make sure the battery is adequately charged. Using the starter motor with a weak battery results in a slower engine cranking speed as well as no spark at the spark plug.
- .The ignition timing cannot be adjusted since the ECM is factory preset.
- .When servicing the ignition system, always follow the steps in the troubleshooting table.
- .For following components information, refer to each section.
 - ignition switch
 - engine stop switch
 - main relay
 - bank angle sensor
 - sidestand switch
 - neutral switch
 - neutral diode

TROUBLESHOOTING

.Inspect the following before diagnosing the system.

-Faulty spark plug

-Loose spark plug cap or spark plug wire connection

-Water got into the spark plug cap (Leaking the ignition coil secondary current)

.If there is no spark at cylinder, temporarily exchange the ignition coil with a known good one and perform the spark test. If there is spark, the original ignition coil is faulty.

."Initial voltage" of the ignition primary coil is the battery voltage with the ignition switch turned ON and engine stop switch turned "⏻"

No spark at spark plug

Unusual condition		Probable cause (Check in numerical order)
Ignition coil primary voltage	When the ignition switch is turned on and the engine stop switch is switched to "OFF" position, there is no initial voltage (other electrical components are normal)	<ol style="list-style-type: none"> 1. Purple line break between main relay and ignition coil. 2. Failure of the main relay or its associated circuit. 3. Loose or poor connection of main terminal or open main coil.
	The initial voltage is normal, but the voltage drops by 2-4v when the engine is started	<ol style="list-style-type: none"> 1. The battery is under-charged (the voltage drops significantly when the engine starts). 2. There is no voltage between the red and white (+) wires at the ECU connector and the body ground (-) or the ECU connection is loose 3. The green wire of the ECU is open or the connection is loose. 4. The black-blue or yellow-red wires between the ignition coil and the engine control module are open or loosely connected 5. Failure of side bracket switch or neutral switch: <ul style="list-style-type: none"> -Side bracket switch circuit: green and white black -Neutral switch circuit: green and green red 6. ECU is faulty (if No. 1 to No. 5 and above are normal)
	Peak voltage is lower than standard value.	<ol style="list-style-type: none"> 1.1. The multimeter impedance is too low; below 10 MQ/DCV. 2. Cranking speed is too low (Battery is undercharged). 3. The sampling timing of the tester and measured pulse were not synchronized (System is normal if measured voltage is over the standard voltage at least once). 4. Faulty ECU (in case when above No. 1 through 3 are normal)..
	Initial and peak voltages are normal but no spark jumps.	<ol style="list-style-type: none"> 1. Faulty spark plug or leaking ignition coil secondary current. 2. Faulty ignition coil
CKP sensor	Peak voltage is lower than standard value	<ol style="list-style-type: none"> 1. The multimeter impedance is too low; below 10 MQ/DCV. 2. Cranking speed is too low (Battery is undercharged). 3. The sampling timing of the tester and measured pulse were not synchronized (System is normal if measured voltage is over the standard voltage at least once). 4. Faulty CKP sensor (in case when above No. 1 through 3 are normal)
	No peak voltage	<ol style="list-style-type: none"> 1. Faulty peak voltage adaptor. 2. Faulty CKP sensor.

SYSTEM LOCATION



IGNITION SYSTEM INSPECTION

NOTICE: If there is no spark on the plug, before measuring the peak voltage, check whether all connections are loose or have poor contact. Use a commercial digital multimeter with a minimum impedance of 10 M Ω /DCV. According to the internal impedance of the multimeter, the displayed value is different. If you use a peak voltage tester (U.S. only),

Please follow the manufacturer's instructions. Use a peak voltage tester or connect a peak voltage adaptor [1] to a digital multimeter [2]

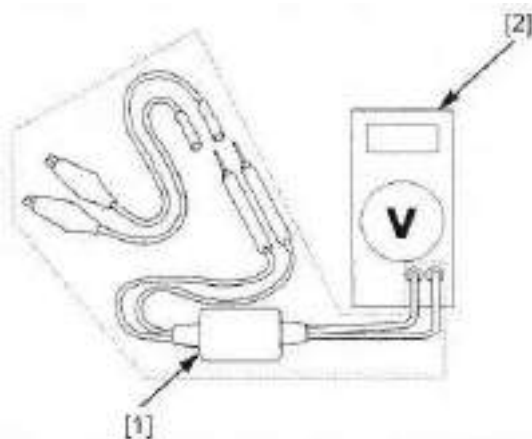

MTPO7-0286 (U.S. only) or
07HGJ-0020100 (not applicable
in the U.S.)

IgnitionMate peak voltage tester Peak voltage adaptor with commercially available digital multimeter (impedance 10 M Ω /DCV minimum)

IGNITION COIL PRIMARY PEAK VOLTAGE

NOTICE:

Check all system connections before performing this inspection. Loose connectors can cause incorrect readings. Check the cylinder compression and check that the spark plugs are installed correctly in the cylinder head.

.Remove the ignition coils

Temporarily install the following components to the wiring harness by connecting each connector -ECU; 48P (black); -ignition coil
Connect a known good spark plug [1] to the spark plug cover, and ground it to the cylinder head connection connector as done in the spark test, connect the peak voltage tester or adapter [2] probe to the ignition coil Primary terminal [3] and ground

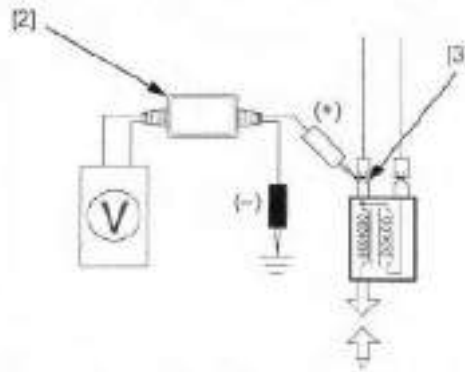

CONNECTION:

No. 1 (left) ignition coil: black yellow (+)-purple (+)

No. 2 (right) ignition coil: black blue (+)-purple (+)

Avoid touching the spark plug and tester probes to prevent electric shock

Turn the ignition switch ON with the engine stop switch "⏏". Check the initial voltage at this time. The battery voltage should be measured. If the initial voltage cannot be measured, follow the checks described in the troubleshooting table. Shift the transmission into neutral. Crank the engine with the starter motor and read ignition coil primary peak voltage.

PEAK VOLTAGE: 100 V minimum

NOTICE: Although the measured value of each ignition coil is different, as long as the voltage is close to the specified value, the measured value is normal. If the peak voltage is lower than the standard value, please follow the inspection described in the troubleshooting table. Install and remove in the reverse order of removal Parts under

CKP sensor peak voltage

NOTICE: Check the cylinder compression and check that the spark plugs are installed correctly in the cylinder head. Disconnect the ECU 48P (black) Test probe Connect the peak voltage tester or adapter [1] probe to the ECU 48P (black) connector [2] terminal on the harness side.

TOL: Test probe (2 required)

CONNECTION: Blue/white (+) -Green/white (-)

Switch the transmission to neutral and use the engine stop switch "🛑" to turn on the ignition. Start the engine with the starter motor and measure the peak voltage of the crankcase position sensor.

PEAK VOLTAGE: 0.7 V minimum

If the peak voltage measured on the ECU 48P (black) connector is abnormal, measure the peak voltage on the CKP connector. .

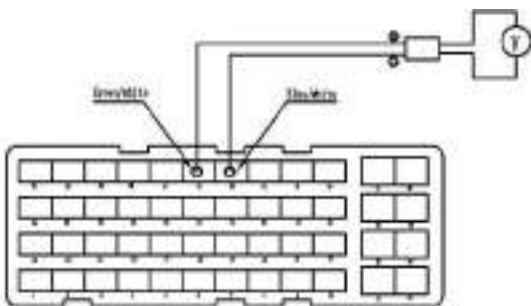

Turn off the ignition switch. Release the wire clamp and disconnect the 2P (white) connector of the CKP sensor [1]. Connect the peak voltage tester or adapter probe to the 2P (white) connector terminal on the CKP sensor side. 2

Connection method: black (+)-green (-)

Measure the peak voltage in the same way as the ECU 48P (black) connector.

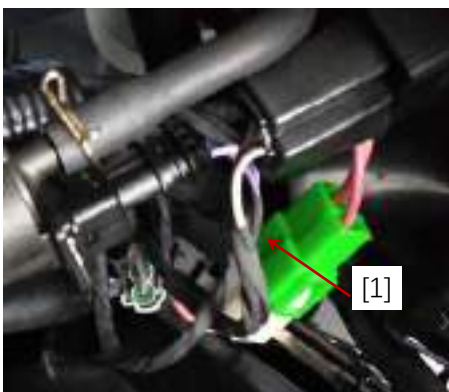

IGNITION SYSTEM

Note: If the peak voltage measured on the ECU (about 12V) is abnormal, and the peak voltage measured on the CKP sensor is normal, it indicates that the wiring harness is open, shorted or loosely connected. If the peak voltage on the crankcase position sensor side is lower than the standard Value, please operate according to the inspection described in the troubleshooting table. Replace the CKP sensor and install the removed parts in the reverse order of removal

IGNITION TIMING

Note: Since the ECU is factory preset, the ignition timing cannot be adjusted. To remove/install the fuel tank, you need to connect the timing light [1] to the spark plug wire to start the engine, warm it up to normal operating temperature and stop. Stop the engine and Remove the crankshaft hole cover. Without disconnecting the spark plug cover, remove the fuel tank under the tray from the frame, and then connect the timing light. Temporarily install the fuel tank under the tray. Lower the fuel tank until the fuel pump can be connected and supported 4P (white) connector. Temporarily connect the fuel pump 4P (white) connector. Start the engine and let it run idly.

IDLE SPEED: 1400±100rpm

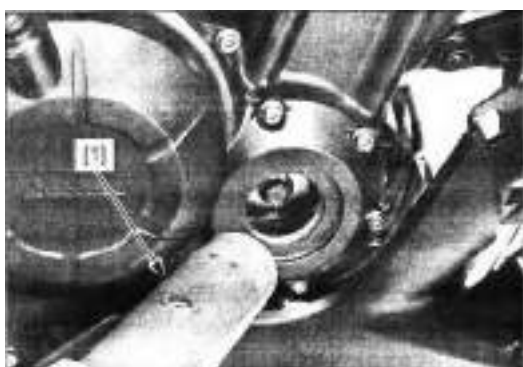

If the "F" mark [2] on the main drive gear is aligned with the index groove [3] on the right crankcase cover, the ignition timing is correct. Apply engine oil to the new O-ring and install it on the crankshaft. Apply grease to the threads of the crankshaft hole cover in the groove of the hole cover and install it. Tighten the crankshaft hole cover to the specified torque.

TORQUE: 18 N.m (1.8 kgf.m, 13 lbf.ft)

Remove the timing lamp in the reverse order of connection. Install the fuel tank under the tray



IGNITION COIL

REMOVAL/INSTALLATION

Remove the fuel tank under tray. Remove the nuts [1] and bolts [2]. First remove no. 1 (left) ignition coil [3], then remove no. 2 (right) ignition coil [4]. Installation is in the reverse order of removal.

NOTE:

Do not interchange the ignition coils.

-1# (left) ignition coil; long wire

-2# (right) ignition coil; short wire

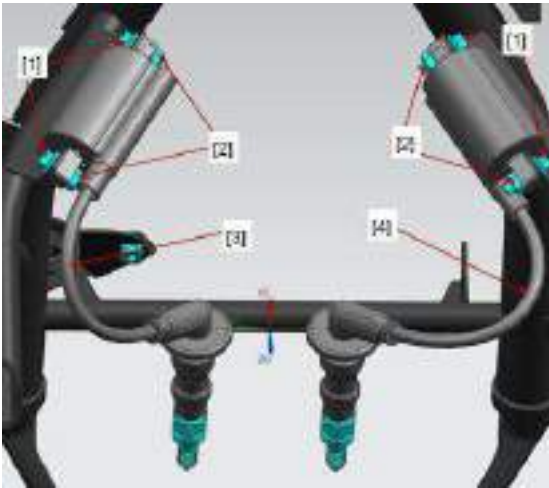

6.ELECTRIC STARTER

SERVICE INFORMATION ----- 6-1

STARTER MOTOR ----- 6-5

TROUBLESHOOTING ----- 6-2

STARTER RELAY SWITCH ----- 6-8

SYSTEM LOCATION ----- 6-4

FUSE ----- 6-10

SERVICE INFORMATION

GENERAL

. If the current is kept flowing through the starter motor turn it while the engine is not cranking over, the starter motor may be damaged.

. The starter motor can be serviced with the engine installed in the frame.

. Always turn the ignition switch OFF before servicing the starter motor. The motor could suddenly start, causing serious injury.

. A weak battery may be unable to turn the starter motor quickly enough, or supply adequate ignition current.

. When servicing the starter system, always follow the steps in the troubleshooting flow chart.

. For following components information, refer to Lights/Meters/Switches section.

- ignition switch
- engine stop switch
- starter switch
- clutch switch
- sidestand switch
- neutral switch

TROUBLESHOOTING

NOTE: .Ensure the battery is fully charged and in good condition. Check the primary fuse (30 A) and secondary fuse (ignition switch: 20 A) for fuses. (If the fuse fuses again, please check whether the relevant wires are short-circuited) The starting motor shall operate under the following conditions.

-Gearbox in neutral or pinched clutch side bracket switch back.

-Ignition switch on, engine stop switch to “”

-The starter switch has been pressed.

Starter motor does not turn

1. Starter Relay Switch Operation Inspection

Check the operation of the starter relay switch as above starting conditions.

Does the starter relay switch click?

YES - GO TO STEP 2

NO - GO TO STEP 3

2. Starter Motor Inspection

Apply battery voltage directly to the starter motor and check the operation. (A large amount of current flows, so do not use a thin wire).

Does the starter motor turn?

YES - • Poorly contacted starter motor cable
• Faulty starter relay switch

NO- Faulty starter motor

3. Check the power input line of the relay coil

Check the power input circuit of the start relay switch Is the input line normal?

YES-Go to step 4.

NO--Ignition switch failure

·Engine shutdown switch failure ·

Start switch failure

·Neutral fuse failure

·The relevant connector terminals in the wiring harness are in poor contact or open circuit.

4. Relay Coil Ground Line Inspection

Check the ground line of the starter relay switch.

Is the ground line normal?

YES- GO TO STEP 5

NO- • Faulty neutral diode

• Faulty sidestand switch

• Faulty clutch switch

• Loose or poor contact of the related connector terminal Open circuit in wire harness.

6. Starter Relay Switch Inspection

Check the starter relay switch.

Is the starter relay switch normal?

YES-Loose or poor contact of the starter relay switch connector terminal

NO- Faulty starter relay switch

Starter motor turns slowly

• Low battery voltage

• Poorly connected battery cables

• Poorly connected starter motor cable

• Faulty starter motor

Starter motor turns, but engine does not turn

·Failure of the starting clutch or starting gear train

·Ignition system failure

·Too little fuel

SYSTEM LOCATION

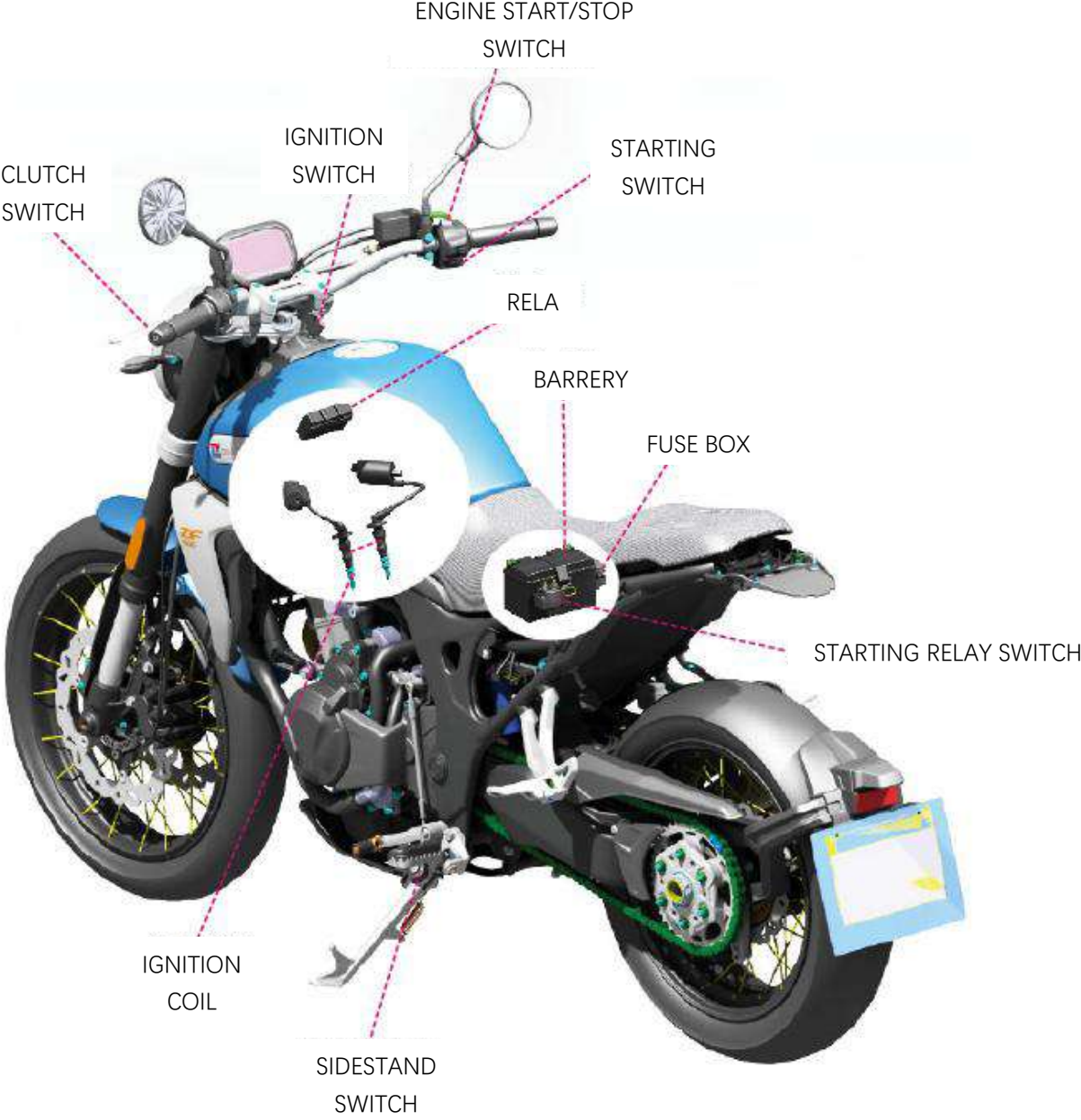

STARTER MOTOR

REMOVAL/INSTALLATION

Remove the following:

Disconnect the negative (-) cable from the battery, remove the throttle body air filter housing assembly, remove the two mounting bolts [1] and the negative (-) cable [2]. Disconnect the positive (+) cable of the starter motor) Remove the starter motor from the crankcase [3].

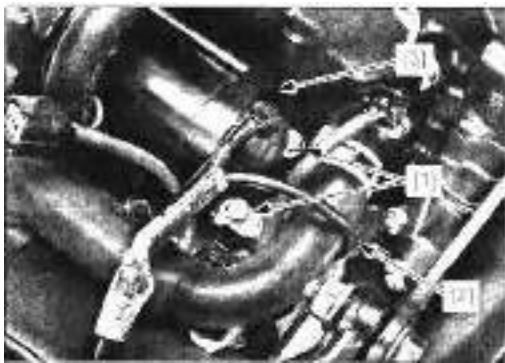

Release the terminal cap [1]. Remove the end nut [2] remove the starting motor [4].

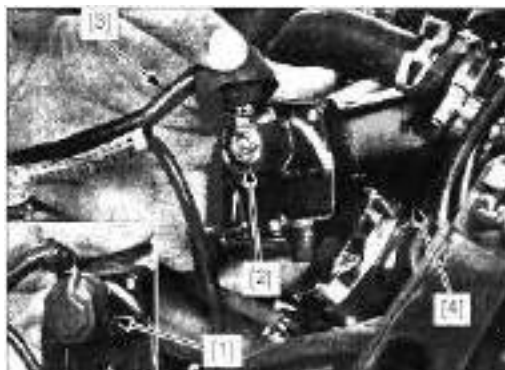

Remove the O-ring [1]. Installation is in the reverse order of removal..

NOTICE:

Replace the O-ring with a new one and coat it with engine.

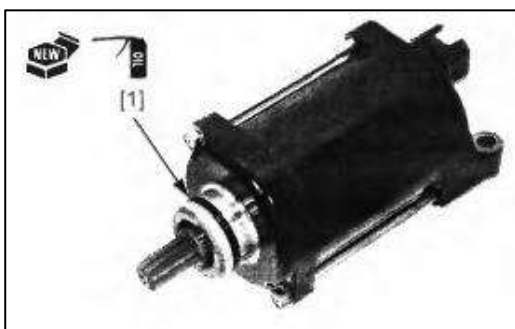

ELECTRIC STARTER

DISASSEMBLY/ASSEMBLY

Disassemble and assemble the starter motor according to the following figure

Note: If the magnet pulls the armature towards the motor housing, the coil may be damaged.

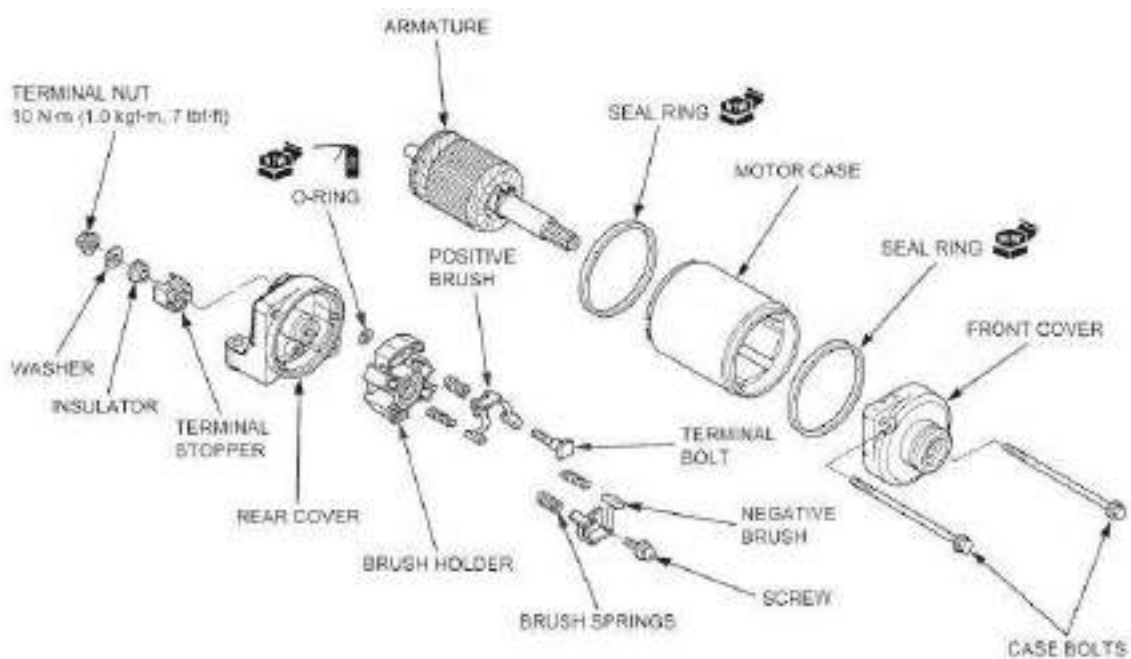

NOTICE:

Install the armature [1] into the motor housing from the housing groove [2] side with the commutator lever facing the rear side. When installing the rear cover [3], align the tongue with the groove (index line [4] Alignment). When installing the front cover [5]. Take care to prevent damage to the oil seal lip with the armature shaft. Align the index line on the front cover and the motor housing [6]

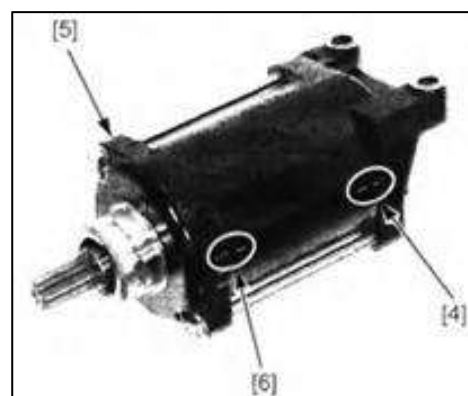
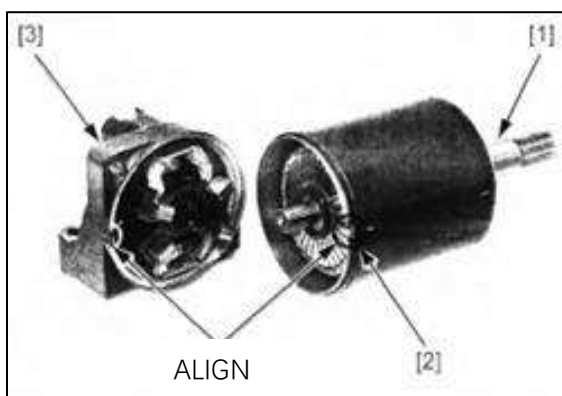

INSPECTION**FRONT COVER**

Check whether the oil seal [1] in the front cover is deteriorated, worn or damaged. Use your fingers to rotate the inner ring of the bearing [2]. The bearing should rotate smoothly. At the same time, check whether the outer race is tightly matched with the front cover.

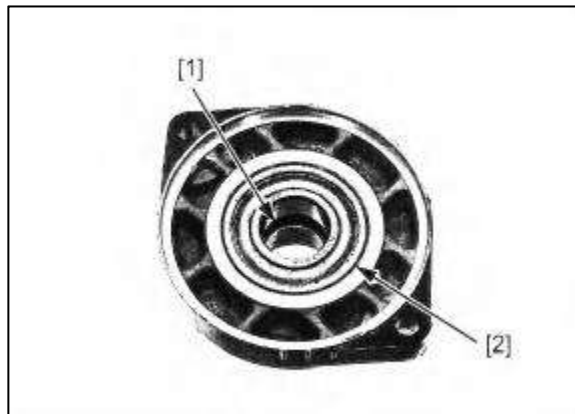
**REAR COVER**

Check whether the bushing [1] in the back cover is worn or damaged. Check whether the carbon brush is damaged and measure the length of the carbon brush. Use limit: 6.5 mm (0.26 in)

Check the continuity of the back cover according to the following steps:

- There should be continuity between the positive brush [2] and the cable terminal.
- Between the cable terminal and the back cover: there should be no conduction.
- Between the negative brush [3] and the back cover: there should be conduction.

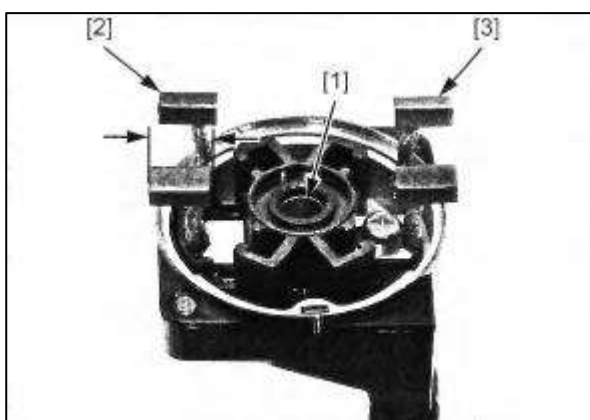

ARMATURE

Remove the metal debris on the commutator rod [1]. Check whether the commutator rod is discolored.

Check the continuity on the rotor,

As follows:

- Between a pair of commutator rods; there should be continuity
- Between each commutator rod and the armature shaft [2];

There should be no continuity

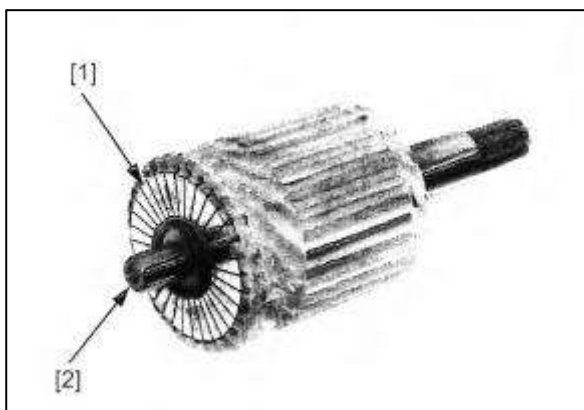
**STARTER RELAY SWITCH****OPERATION INSPECTION**

Remove the seat cushion. Put the gearbox into neutral or squeeze the clutch, and retract the side bracket. Turn on the ignition switch with the engine stop switch turned to "OFF", and press the start switch. If the starter relay switch [1] Click sound, the coil is normal. If you do not hear the "click" sound of the start relay switch, check the relay coil circuit



ELECTRIC STARTER

RELAY COIL CIRCUIT INSPECTION

Loosen the connector sheath from the starter relay switch 4P (red) connector [1] of the power input wire. Turn on the ignition switch when the engine stop switch is turned to "", and measure the voltage between the 4P (red) connector terminal and the surroundings .

Connection: yellow-red (+)-green-red (-)

When the start switch is pressed, the yellow and red wires (+) should have voltage

GROUND LINE

Turn off the ignition switch, disconnect the start relay switch 4P (red) connector [1] Check the continuity between the 4P (red) connector terminal and the green-red ground

Connection: green red-ground.

When the gearbox is in neutral or when the clutch lever is tightened, continuity should be maintained.

**RELAY INSPECTION**

Remove the starting relay switch, as shown in the figure, connect the 12 V battery to the starting relay switch. When connecting the battery, the cable terminals should be conductive, and disconnecting the battery should not be conductive.

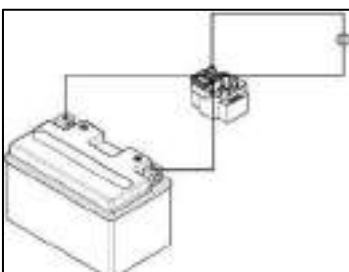

REMOVAL/INSTALLATION

Remove the following:

Remove the right side cover, disconnect the negative (-) cable from the battery, disconnect the start relay switch 4P (red) connector [1], remove the socket bolt [2] to disconnect the cable, take out the start relay switch from the mounting base [3]. The installation sequence is opposite to the removal sequence



FUSE

INSPECTION

Remove the following:

-SEAT

Loosen the two bosses, remove the fuse box cover from the left fuse box, and remove the fuse



Check the connection between fuse terminals.

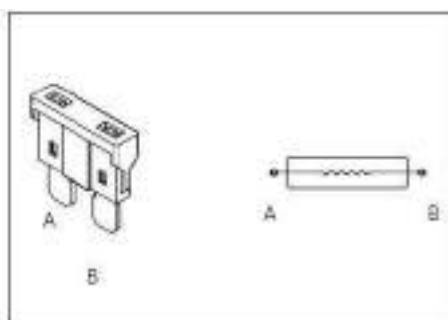

7.FUEL SYSTEM

MAINTENANCE INFORMATIO -----7-1	FUEL RAIL ASSEMBLY ----- 7-18
COMPONENT LOCATION -----7-2	IDLE SPEED MOTO----- 7-18
FUEL LINE INSPECTION ----- 7-3	IACV ----- 7-21
FUSE TANK ----- 7-9	EVAP CANISTER -----7-22
FUEL PUMP UNIT -----7-9	FUEL PUMP RELAY -----7-22
THROTTLE BADCY/AIR FILTER ----- 7-12	

SERVICE INFORMATION

GENERAL

Bending or twisting the control cable will impair smooth operation and could cause the cables to stick or bind, resulting in loss of vehicle control.

- Work in a well ventilated area. Smoking or allowing flames or sparks in the work area or where gasoline is stored can cause a fire or explosion.
- Before disconnecting the fuel feed hose, relieve fuel pressure from the system.
- Do not snap the throttle valve from full open to full close after the throttle cable has been removed. It may cause incorrect idle operation.
- Seal the intake port with a piece of tape or a clean cloth to keep dirt and debris from entering the engine after the throttle body has been removed.
- Do not damage the throttle body. It may cause incorrect throttle valve operation.
- Prevent dirt and debris from entering the throttle bore and air passages after the throttle body has been removed. Clean them using a compressed air if necessary.
- Do not loosen or tighten the white painted nut and screw of the throttle body. Loosening or tightening them can cause throttle valve and idle control failure.
- Do not apply commercially available carburetor cleaners to the inside of the throttle bore.
- The parts of the throttle body not shown in this manual should not be disassembled.
- For maintenance of fuel injectors and idle air control valves, the throttle body shall be removed/installed.
- For fuel level sensor inspection
- The following color codes are used throughout this section.

Bl=Black	G=Green	Lg=Light green	R=Red	Y=Yellow
Br=Brown	Gr=Gray	O=Organge	V=Violet	
Bu=Blue	Lb=Light blue	P=Pink	W=White	

COMPONENT LOCATION

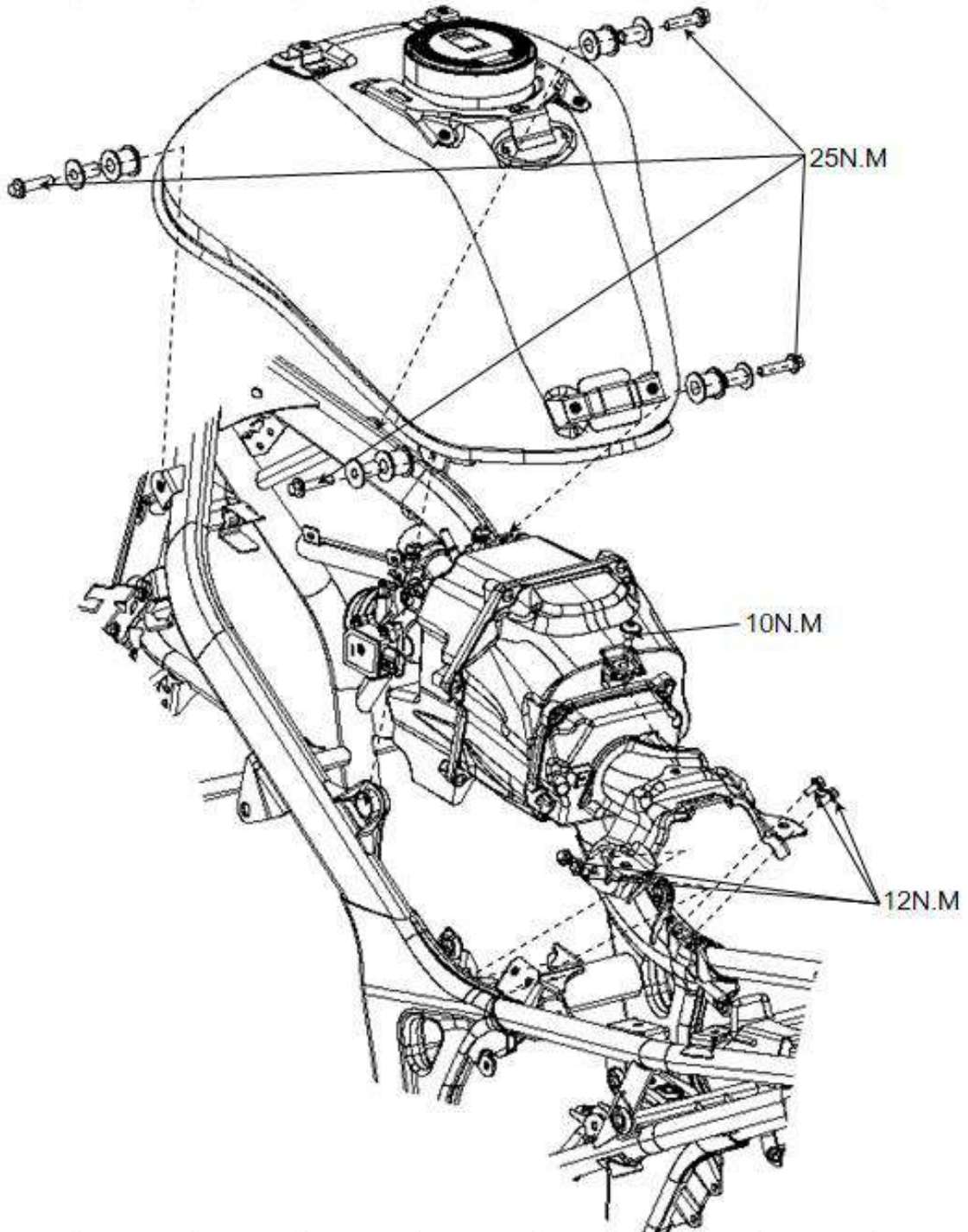

FUEL LINE INSPECTION

FUEL PRESSURE RELIEVING

NOTE:

- Before disconnecting fuel feed hose, relieve pressure from the system as follows.
1. Turn the ignition switch OFF.
 2. Remove the left side cover.
 3. Disconnect the fuel pump 3P (Black) connector [1].
 4. Start the engine, and let it idle until the engine stalls.
 5. Turn the ignition switch OFF.



QUICK CONNECT FITTING REMOVAL

NOTE:

- Disconnect the fuel supply hose before cleaning around the quick coupling, and make sure that no dirt enters the fuel system.

- Do not bend or twist the fuel supply hose.

1. Release fuel pressure
2. Disconnect the negative (-) cable and battery from the top
3. Lift the fuel tank and support it.
4. Put a towel on the quick connector. Pull out from the holder and loosen the joint rubber [1].

5. Hold the connector with one hand and squeeze the retainer tabs [2] with the other hand to release the locking pawls [3], then pull the connector off the fuel Pipe.

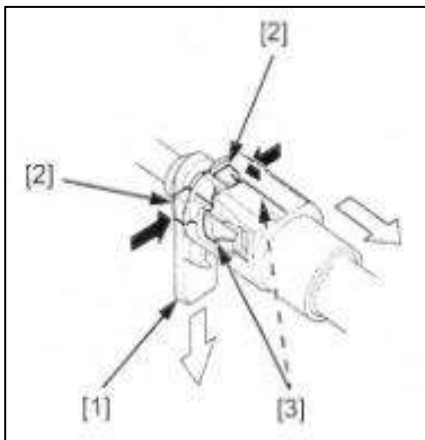

NOTE:

- Be careful not to damage the fuel feed hose, connector and fuel pipe. Do not use tools.
- Prevent the remaining fuel in the fuel feed hose from flowing out, using a shop towel.
- If the connector does not move, alternately Pull and push the connector until it comes off easily.

6. Remove the retainer and joint rubber from the fuel pipe.

7. To prevent damage and keep foreign matter out, cover the connector and fuel pipe with plastic bags [1].

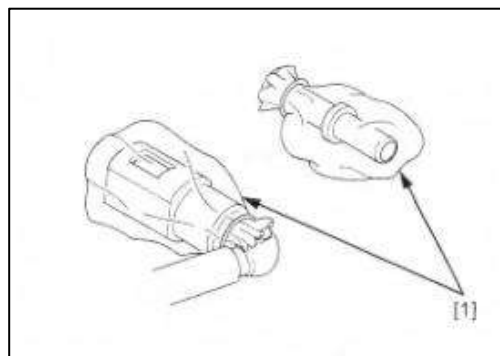

QUICK CONNECT FITTING INSTALLATION

NOTE:

·When disconnecting the fuel supply hose, be sure to replace the retainer and joint rubber.

Use the same type of cage and joint rubber that were removed.

Do not bend or twist the fuel supply hose.

1. Align the locking claws of the new holder [1] with the holes and insert it into the connector [2].

2. Install the new joint rubber [1] on the fuel pipe. Install the joint directly on the fuel pipe, as shown in the figure, align the holder groove with the rubber tab of the joint. Press the connector until the two locking claws [2] Locked.

Notice:

If the connection is difficult, add a small amount of oil to the end of the pipe.

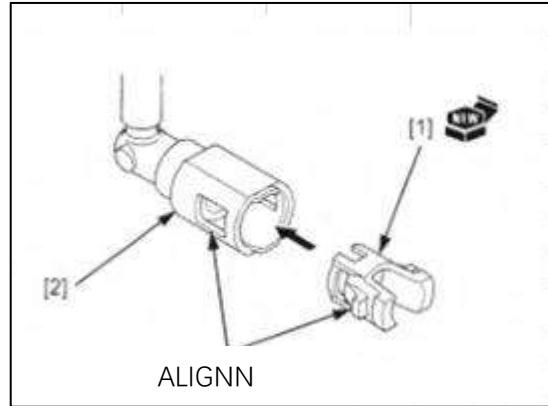
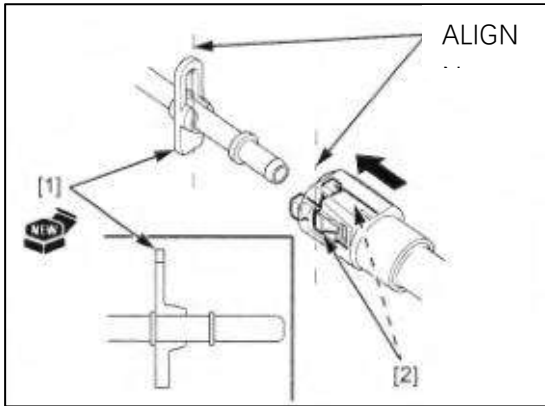

3.3. Ensure that the quick connector is firmly connected, and firmly lock the locking claw [1] by pulling the connector. As shown in the figure, make sure that the connector rubber boss [2] is located between the fixed bosses [3].

4. Temporarily lower the fuel tank

5. Connect the battery negative (-) cable

6. Make fuel pressure normal

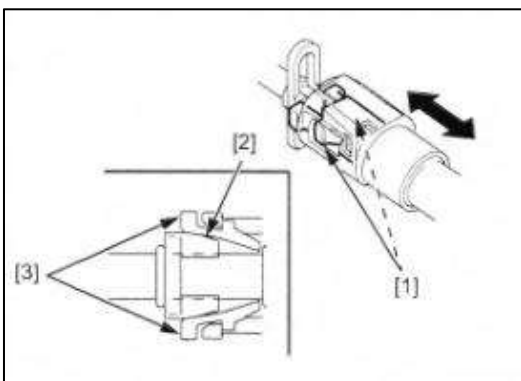

FUEL PRESSURE NORMALIZATION

1. Be sure the fuel pump 3P (Black) connector [1] is connected.
2. Turn the ignition switch ON with the engine stop switch “”

**Notice:**

Do not start the engine, the fuel pump will run for about 2 seconds and the pressure will rise. Turn off the ignition switch

3. Repeat step 2 two to three times and check that there is no leakage.
4. Install the fuel tank correctly

FUEL PRESSURE TEST**Notice:**

When lifting the fuel tank, check whether the fuel tank ventilation hose on the frame or the hose from the fuel tank to the evaporative emission carbon canister is squeezed or blocked, and disconnect the quick connector from the fuel tank

TOOL

- [1] Fuel pressure gauge
- [2] Pressure gauge manifold
- [3] Hose attachment
- [4] Hose attachment
- [5] Attachment joint

FUEL SYSTEM

Lower the fuel tank until the fuel pump 4P (white) and connect the connector [6], temporarily connect the fuel pump 4P (white) connector, fuel tank ventilation hose cable. Start the engine and let it run at idle speed. Read the fuel pressure.

STANDARD: 300kPa (3.5 kgf/cm 2,50 psi)

If the fuel pressure is higher than the specified pressure, replace the fuel pump unit. If the fuel pressure is lower than the specified pressure,

Check the following:

- Whether the fuel pipeline is leaking
- Fuel tank ventilation hose (fuel tank side) clamped or blocked
- Clogging fuel filter
- fuel pump

After checking, release the fuel pressure, disconnect the negative (-) cable from the battery and remove the special tool. Connect the quick connector.

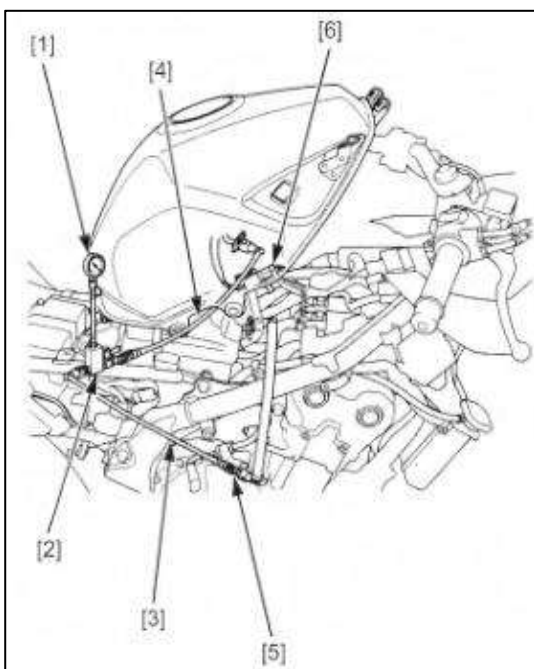

FUEL FLOW INSPECTION**NOTICE:**

When lifting the fuel tank, check whether the fuel tank ventilation hose on the frame or the hose from the fuel tank to the evaporative emission carbon canister is squeezed or blocked. Disconnect the quick connector from the throttle body. Connect the fuel supply hose [1] Put the end of the fuel pump into a gasoline container. Lower the fuel tank until the fuel pump 4P (white) [2] can be connected to the connector. Temporarily connect the fuel pump 4P (white) connector and cable

Use the engine stop switch "🔌" to turn on the ignition switch, and the fuel pump works for 2 seconds, repeating 5 times to meet the total measurement time.

NOTICE:

When the first fuel flows out, return the fuel to the fuel tank. Measure the fuel flow.

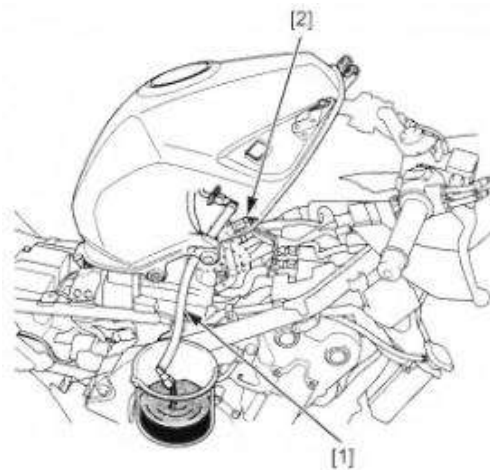
**Amount of fuel flow**

319 cm³ (10.8 US oz, 11.2 Imp oz) minimum/10 seconds at 12 V
(10.8 USoz, 11.2 Imp oz)

If fuel flow is less than specified volume,
inspect the following:

- fuel feed hose for clogs
- fuel tank breather hose (tank side) for pinches or clogs (A, CM types)
- fuel filter for clogs
- fuel pump

Connect the quick connect fitting

FUEL TANK

REMOVAL/INSTALLATION

Disconnect the quick connect fitting from the fuel tank. Lower the fuel tank, being careful not to pinch the wire and hoses. Remove the bolts [1], turn over the bushing [2] and i-ring [3] as well as the fuel tank [4]. Installation is in the reverse order of Removal.

NOTE:

The mounting bolt is installed from the left side.

TORQUE:

Fuel tank mounting nut: 22N·m (2.2kgf·m, 16 lbMt)

Connect the quick connect fitting

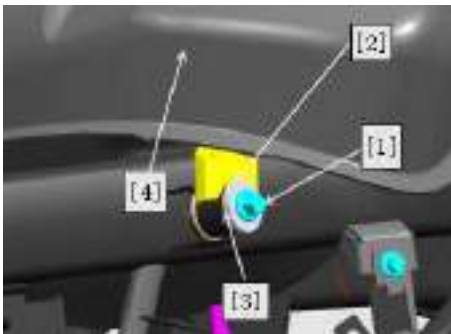

FUEL PUMP UNIT

INSPECTION

Turn on the ignition switch when the engine is stopped, switch "🔌" and confirm that the fuel pump works for 2 seconds. If the fuel pump does not work, check as follows:

Turn off the ignition switch.

Remove the fuel tank guard plate-left

Disconnect fuel pump 4P (white) connector [1].



FUEL PUMP UNIT

INSPECTION

Turn on the ignition switch when the engine is stopped, switch "🔌" and confirm that the fuel pump works for 2 seconds. If the fuel pump does not work, check as follows:

Turn off the ignition switch.

Remove the fuel tank guard plate-left

Disconnect the fuel pump 3P (black) connector [1].



Turn on the ignition switch with the engine stop switch "🔌", and measure the voltage between the 3P (black) connector [1] terminals of the fuel pump on the wire side.

Connection: brown-green (+)-green (-)

There should be battery voltage for 2 seconds. If there is battery voltage, replace the fuel pump unit. If there is no voltage, check the following items:

- Whether the green wire between the fuel pump and the ground is open
- Whether the brown-green wire between the relay box and the fuel pump is open
- fuel pump relay and its circuit

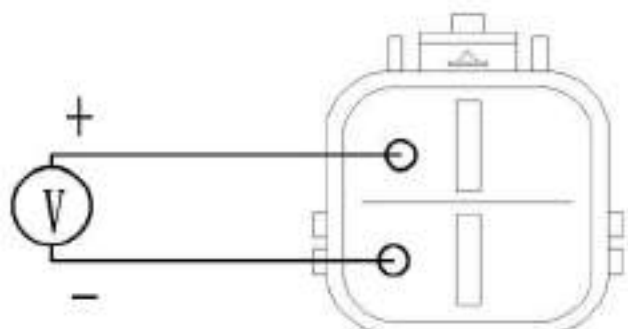

REMOVAL/INSTALLATION

Remove the fuel tank. Clean around the fuel pump. Loosen the six mounting nuts [1] in a crisscross pattern in several steps and remove them. Remove the fuel pump unit [2] and the rubber seal [3].

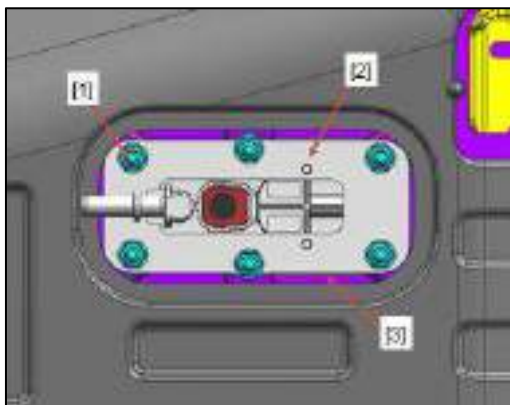

Installation is in the reverse order of removal.

NOTE:

Replace with a new rubber seal [1]. Clean the rubber seal seat area of the fuel tank and fuel pump bottom plate to ensure that there are no foreign objects. Place the rubber seal on the position where the boss faces the fuel pipe [2]. Tighten the two mounting nuts to the specified torque.

TORQUE:

Fuel pump mounting nut: 6N·m (0.5 kgf·m, 3.7 lbf.ft)

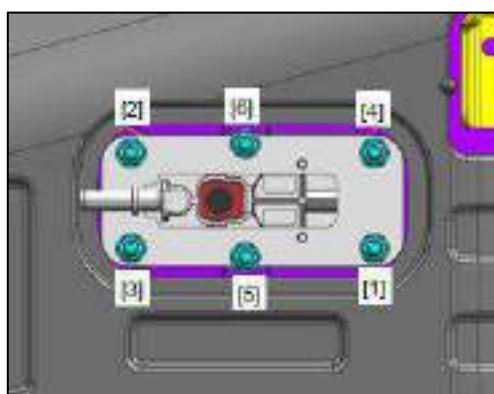
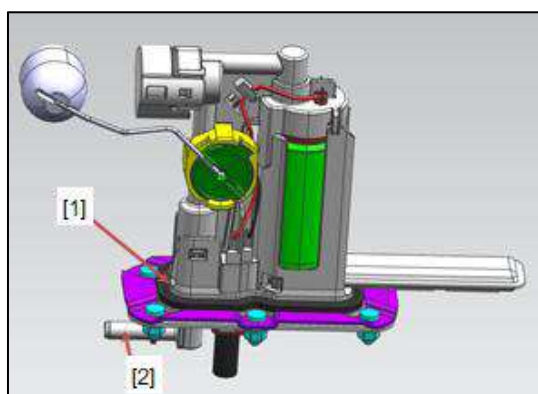

THROTTLE BODY/AIR CLEANER HOUSING

REMOVAL/INSTALLATION

NOTICE:

Be sure to clean the fuel system parts with detergent. Before disassembling, blow compressed air to prevent dust and debris from being in the throttle body. Remove the fuel tank and disconnect the following connections:

-Sensor unit 5P (black) connector[1]

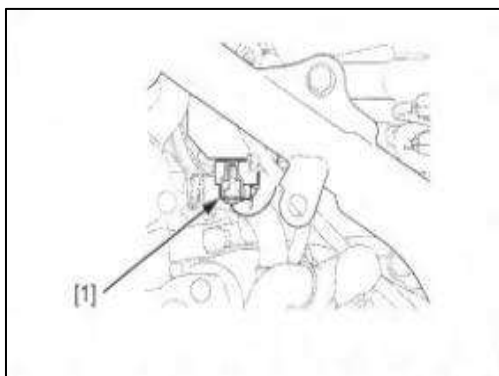

-Injector 2P (gray) connector[1]

-Idle speed motor 4P (black) connector [2]



FUEL SYSTEM

- crankcase breather hose [1]
- Evaporative carbon discharge tank to throttle body hose [3] (from tee joint)

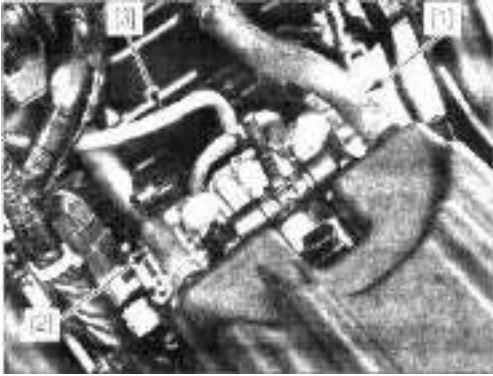

- Throttle cable [1] (Remove from the cable retainer and disconnect from the throttle drum)



Remove the following:

- M6 bolt [1] (loosen)
- four M6 bolts [2]
- seat bracket [3]



Loosen the intake pipe assembly clamp (cylinder head side) [1]

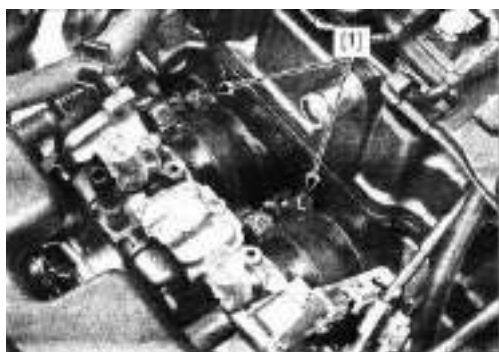

Slide the throttle body/air filter housing assembly to the rear and loosen the intake pipe assembly from the cylinder head [1]. Lift the front of the assembly and remove it from the strut on the air filter housing Engine harness 6P (black) connector [2]. Remove the throttle body/air filter housing assembly from the frame.

The installation sequence is opposite to the removal sequence.

NOTICE:

When putting the components into the frame, place the crankcase breather pipe [3] under the hose, make sure it is not kinked or deformed, and tighten the intake pipe assembly screws. The distance between the belt ends [4] is 10 ± 1.0 mm (0.4 ± 0.04 in), when connecting the injector 2P (gray) connector [5], align the groove with the lug of the injector connector

TORQUE:

Thread connection pull thread tapping screw: 1.0 N·m (0.1 kgf·m, 0.7 lbMt)

Throttle pull connection bolt (at throttle body): 3.0 N·m (0.3 kgf·m, 2.2 lbf·ft)

Adjust the free gap of the throttle handle, if the sensor unit has been removed, execute the throttle position sensor reset procedure

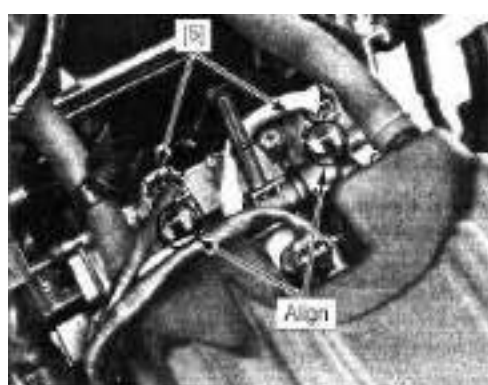
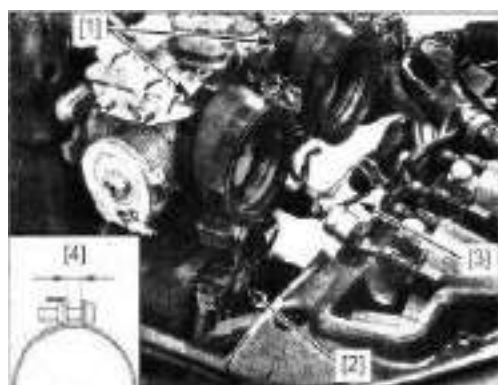

DISASSEMBLY/ASSEMBLY**NOTICE:**

The throttle body is assembled at the factory. It must not be disassembled in any other way than shown in this manual.

·After the throttle cable is removed, do not turn the throttle valve from fully open to fully closed, which may cause damage to the throttle.

·Do not damage the throttle body; this may cause damage to the throttle

- Do not loosen or tighten the nuts[1] and screws[2] that are painted with torque marks.

Loosening or tightening them will cause the throttle body to malfunction.

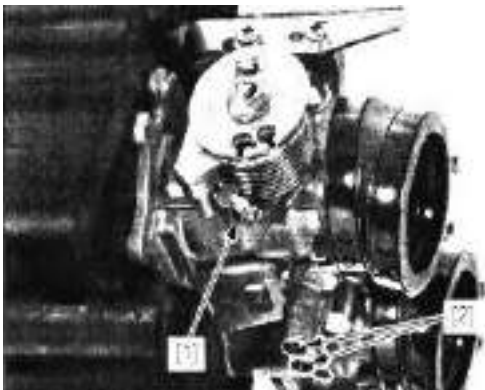
**Remove the following:**

- throttle body insulators [1] (loosen the band screws)
- six tapping screws [2]
- rear air cleaner housing[3]
- three screws[4]
- air funnel[5]
- front air cleaner housing[6]
- throttle body[7]
- rubber seals[8]

Install air filter cover and filter element separately[9]

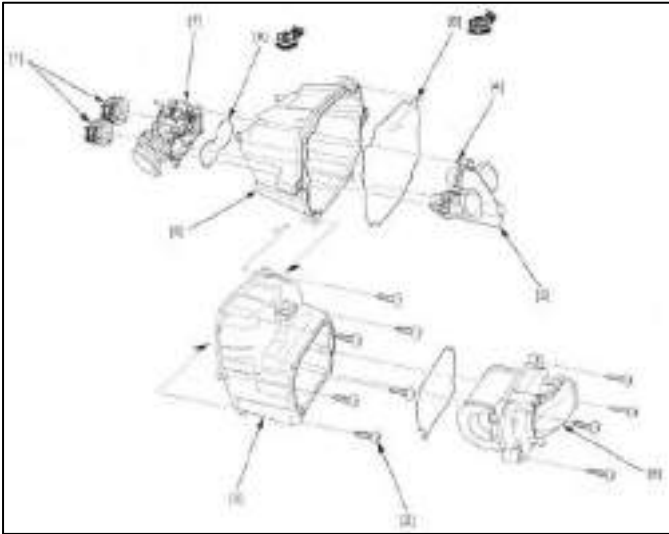

Remove the following:

- Sensor unit
- Fuel rail
- Evaporative carbon tank to throttle body hose[1]
- Three screws[2]
- Idle motor body[3]
- Rubber seal ring[4]
- Two screws[5]
- Throttle pull retainer[6]

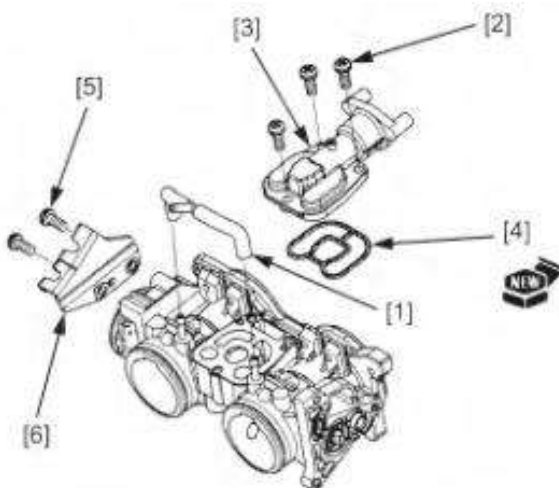

Use compressed air to clean the throttle body and idle speed motor valve body pipeline

NOTICE:

Cleaning with a steel wire ball will damage the throttle body. The assembly sequence is opposite to the disassembly sequence.

NOTICE:

Replace with a new rubber seal. Install each clamp on the intake pipe assembly with the screw head [1] to the right and align the left belt hole [2] with the positioning boss. Install each clamp so that the "UP" mark [3] faces UP towards the throttle body and aligns the grooves [4] with the lugs. Tighten the clamp screw so that the distance between the two ends [5] is 10 ± 1.0 mm (0.4 ± 0.04 in)

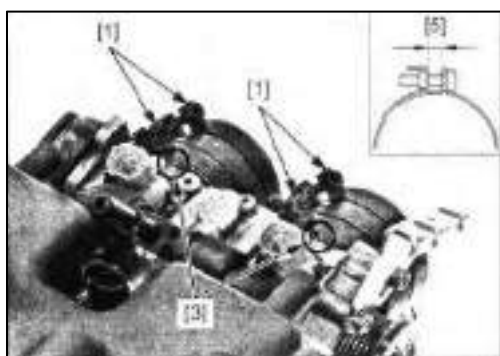

TORQUE:

Throttle wire retainer screw: 3.4 N·m (0.3 kgf·m, 2.5lb·ft)

Idle motor body screw: 3.4 N·m (0.3 kgf·m, 2.5lb·ft)

Air filter housing assembly tapping screw: 1N·m (0.1 kgf·m, 0.8lb·ft)

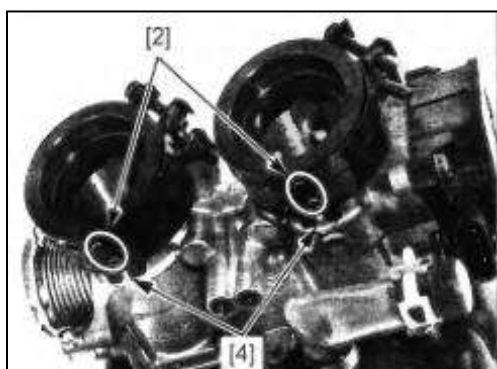

FUEL RAIL

REMOVAL/INSTALLATION

Remove the oil rail from the throttle assembly

Remove the following:

- 2 bolts[1]
- 2 wire harness connector[2]-

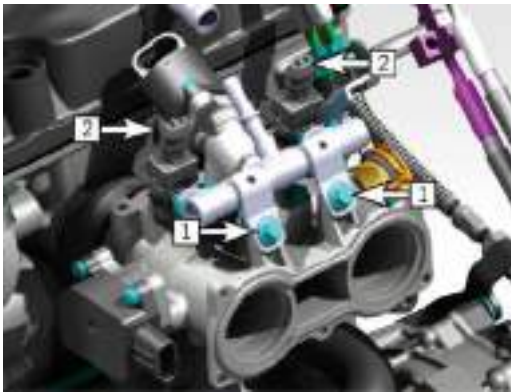

- fuel pipe[1]
- O-rings[2]

Check each part for wear or damage and replace it if necessary.



Installation is in the reverse order of removal

NOTICE:

- Replace the O-rings and seal rings with new ones and coat them with engine oil.
- When installing the fuel injector, be careful not to damage the O-ring.
- Align the injector connector with the fuel pipe.

TORQUE:

Oil rail assembly connecting bolt: 12N·m (1.2 kgf·m,8.9lbf.ft)

**Idle speed motor****INSPECTION**

The idle speed motor is installed on the throttle body and operated by a stepping motor. When the ignition switch is turned on, the idle speed motor works for a few seconds. Raise the fuel tank and support the engine stop switch "ⓘ" to turn on the ignition switch and check the idle speed motor. If there is no If no operation (beep) sound is heard when MIL is flashing, perform the following checks:

Remove the idle speed motor (idle air control valve)

Check the idle speed motor slide valve [1] and idle speed motor in the throttle body

Whether the air channel has carbon deposits.

Check the O-ring [2] on the idle motor for deterioration or damage.

Temporarily install the following components to the wiring harness by connecting each connector:

- Throttle body; injector 2P (gray) and sensor unit 5P (black)
- Idle speed motor; 4P (black) [3]

Use the engine stop switch "⏻" to turn on the ignition switch, while gently holding the spool valve, the spool valve should move back and forth. Turn off the ignition switch. Disconnect the connector, and remove the throttle body and idle speed motor from the wiring harness. Install the idle speed motor

REMOVAL/INSTALLATION

Remove the throttle body from the air filter housing

Remove the following:

- two screws[1]
- setting plate[2]
- Idle speed motor[3]
- O-ring[4]

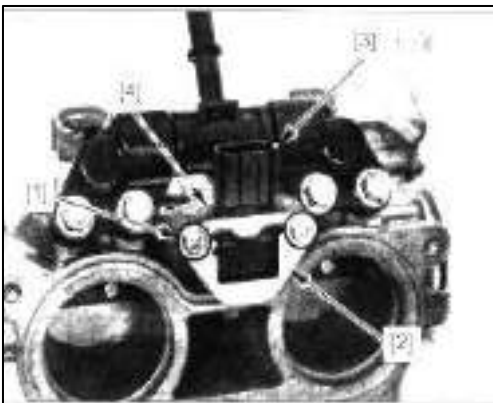

Evaporation discharge cleaning control

REMOVAL/INSTALLATION

Remove the fuel tank

Disconnect the following connections:

- 2P (black) connector[1]
- EVAP to throttle body hose [2]
- EVAP canister to EVAP control solenoid valve valve hose [3]

Remove the following:

- Two cap nuts [4] and washers [5] (external)
- Two bolts [6] and EVAP control solenoid valve valve [7]
- Two collars [8] (inside)

The installation sequence is opposite to the removal sequence.

INSPECTION

Disassemble the EVAP discharge cleaning control solenoid valve and check the air flow through the solenoid valve. Air cannot be fed from the hose connector (A)
Flow direction output hose connector (B). Connect the 12V battery to the EVAP emission cleaning control, solenoid valve 2P connector [1] terminal, when the battery is connected, air should be circulated. Measure evaporative emission cleaning control solenoid valve 2P connector [1] Resistance between terminals

STANDARD: 17Ω(20°C/68°F)

If the resistance is out of specification, replace the EVAP emission purge control solenoid valve

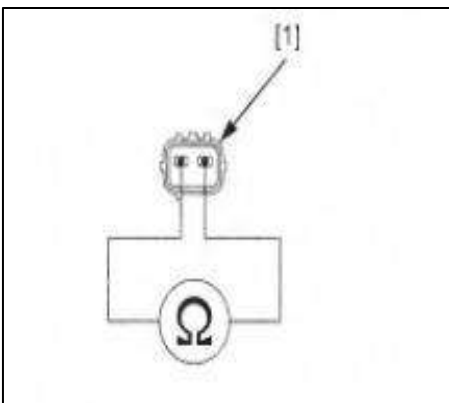

EVAP(evaporation emission)CANISTER

REMOVAL/INSTALLATION

Remove the fuel tank guard plate, disconnect the EVAP carbon canister discharge hose [1]. Remove the mounting bolts [2], and then take the EVAP carbon canister from the bracket [3], disconnect the following connections and remove the EVAP canister

- Fuel tank to EVAP carbon canister hose [4]
- EVAP carbon canister to EVAP cleaning control solenoid valve
- Valve hose [5]

The installation sequence is opposite to the removal sequence.

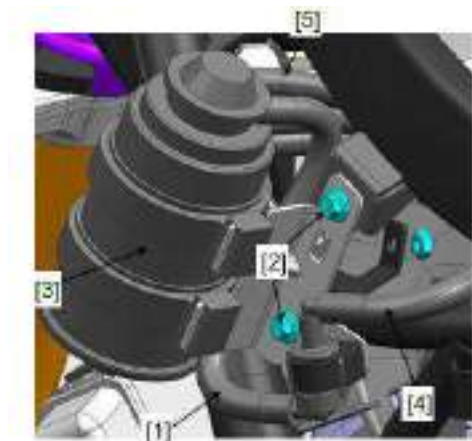

FUEL PUMP RELAY

CIRCUIT INSPECTION

For relay inspection. Remove the fuel pump relay

RELAY SWITCH/COIL POWER INPUT LINE

Measure the voltage between each fuel pump relay terminal of the relay box [1] and ground.

CONNECTION: B (+) - Ground (-)

D (+) - Ground (-)

When the engine stop switch “” is turned on, the storage should have a pool voltage.

If there is no voltage, check the following:

- Main pump and fuel pump relay in relay box
- Main relay and its circuit

SIGNAL LINE

Check for continuity between the fuel pump relay terminal of the relay box [1] and ground.

CONNECTION: C – Ground

The ignition switch should not be turned on when the ignition switch is off. If there is continuity, check whether the brown/black wire between the relay box and the ECU is short-circuited. When turning on the ignition switch with the engine stop switch, keep it for a few seconds. If not For continuity, please check the brown/black wire between the relay box and the ECU.

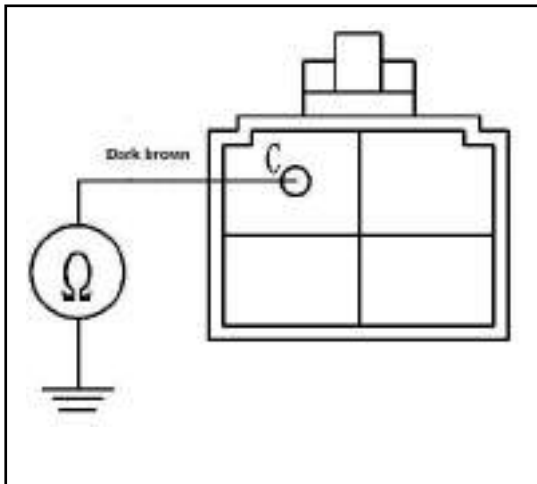

8. COOLING SYSTEM

SERVICE INFORMATION	8-1
SYSTEM FLOW CHART	8-3
SYSTEM TEST	8-4
COOLANT REPLACEMENT	8-5
THERMOSTAT	8-6
RADIATOR/COOLING FAN	8-8
RADIATOR WATER TANK	8-10
WATER PUMP	8-11
WATER HOSE JOINT	8-14

SERVICE INFORMATION

GENERAL



Do not remove the radiator cap before the engine and radiator are cooled to prevent the coolant from splashing out and scalding the person.

NOTICE:

Use of coolant added with silicate corrosion inhibitor will cause premature wear of the water pump seal or blockage of the radiator channel.

Use of tap water can cause engine damage.

·Add coolant to the auxiliary water tank; do not remove the radiator cover except for adding or draining coolant.

There is no need to remove the engine from the frame when repairing the COOLING SYSTEM.

Avoid leakage of coolant to the painted surface.

After the system is MAINTENANCE, use a cooling system tester to check for leaks.

Coolant temperature indicator/water temperature sensor inspection.

Inspection of fan control relay.

TROUBLESHOOTING

Engine temperature too high

Coolant temperature indicator/water temperature sensor failure

- The thermostat is not open
- Failure of radiator cover
- Insufficient coolant

Blockage of radiator passages, hoses, and water pipes

- Circulation system intake
- Cooling fan motor failure
- Fan control relay failure
- Water pump failure

Engine temperature is too low

- Coolant temperature indicator/water temperature sensor failure
- The thermostat is open
- Fan control relay failure

Coolant leak

- Faulty water pump mechanical seal
- Deteriorated O-rings
- Faulty radiator cap
- •Damaged or deteriorated cylinder head gasket
- •Loose hose connection or clamp
- Damaged or deteriorated hose
- Radiator damage
- The joints of thermostat cap and pump cap are loose

SYSTEM FLOW CHART

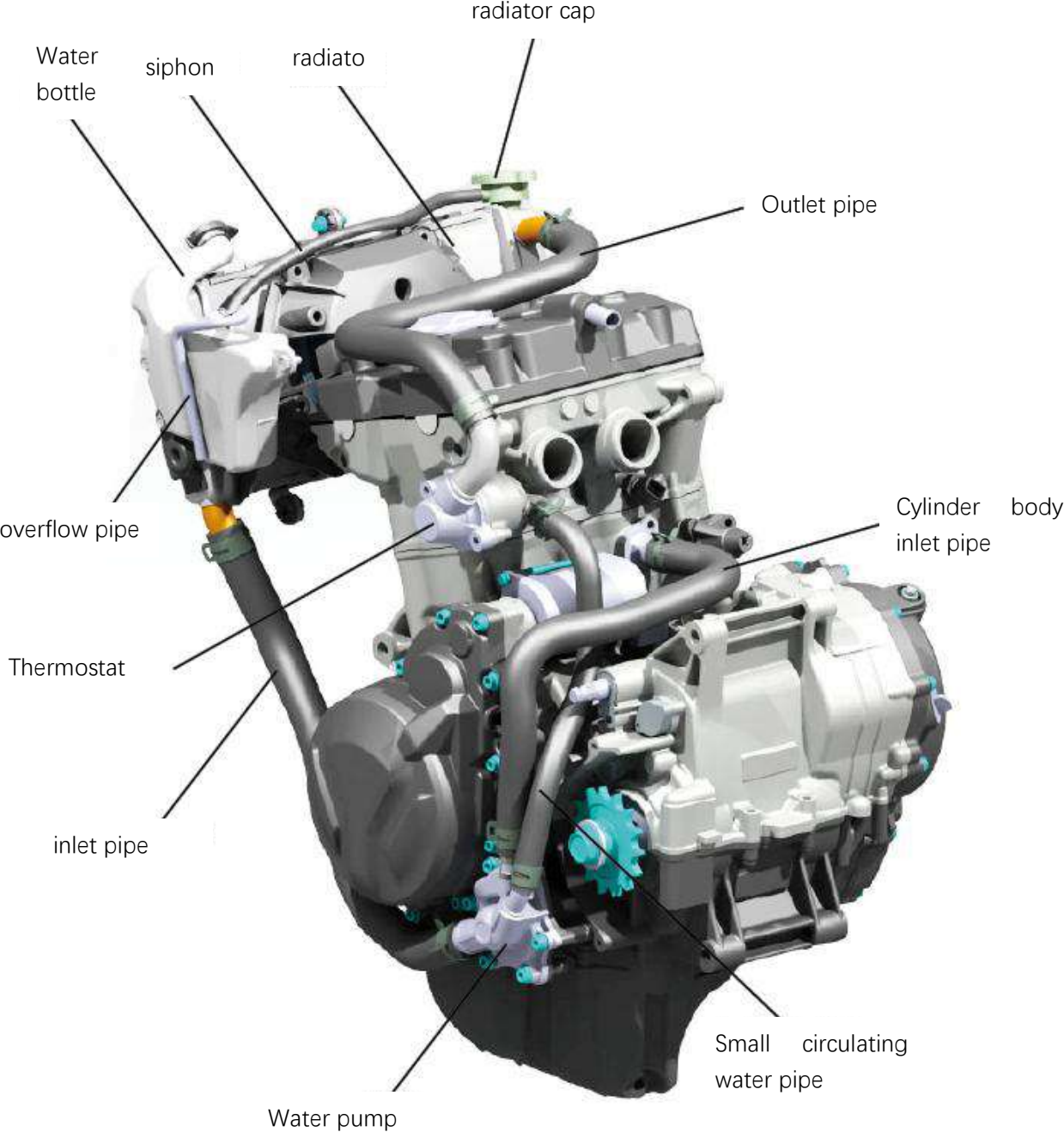

SYSTEM TESTING**RADIATOR CAP/SYSTEM PRESSURE INSPECTION**

Remove the right middle cowl.

Remove the radiator cap [1].



Lubricate the sealing surface of the cover [1]; then install the cover on the tester [2] Use the tester to pressurize the radiator cover. If the radiator cover cannot maintain the pressure or release the pressure too high or too low, replace the radiator Cover. The radiator cover must maintain the specified pressure for at least 6 seconds

RADIATOR CAP RELIEF PRESSURE: 108-137Kp (1.1-1.4 kgf/cm², 16-20 psi)

Connect the detector to the radiator. Use the detector to pressurize the radiator, engine and hoses, and check for leaks.

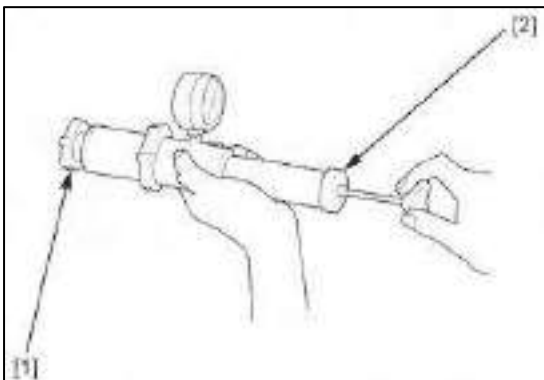
**NOTICE:**

Excessive pressure can damage the cooling system components. Do not exceed **137kPa (1.4 kgf/cm², 20psi)** .Repair or replace components if the system will not hold the specified pressure for at least 6 seconds.

COOLANT REPLACEMENT

REPLACEMENT/AIR BLEEDING

NOTICE:

When adding coolant to the system or the auxiliary water tank or checking the coolant dosage, the motorcycle should be placed on a level ground and in an upright position. Remove the fan fairing and remove the water pump drain bolt and flat washer at position [1]. Remove Lower the radiator cover [2] and drain the coolant. After replacing the new flat washer, install the drain bolt. Tighten the drain bolt to the correct torque.



TORQUE:

Pump drain bolt: 10 N.m (1.0 kgf.m, 10 lbf.ft)

Cylinder discharge bolt: 12 N.m (1.2 kgf.m, 9 lbf.ft)

Disconnect the siphon hose from the radiator [1]. Pull the siphon hose out of the pipe clamp. Place the hose in a lower position outside the engine frame and drain the coolant in the storage tank. Coolant, flush the inside of the storage tank with water. Install the hose into the pipe clamp and the radiator

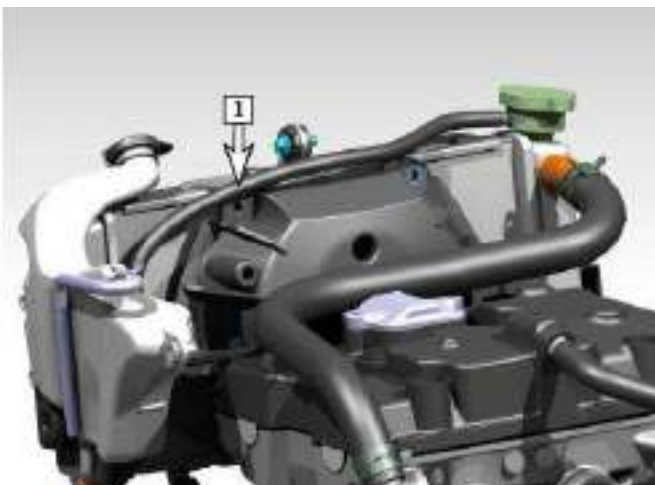

COOLING SYSTEM

Fill the COOLING SYSTEM with the recommended coolant through the water injection hole up to the neck [1]



Antifreeze is recommended:

Contains ethanol and does not contain silicate coolant

Coolant concentration standard:

Mix with distilled water 1 1:1

Remove the air from the system as follows:

1. Shift the engine to neutral. Start the engine and let it idle for 2-3 minutes.
2. Open and close the throttle three to four times to exhaust the air in the system.
3. Turn off the engine and add coolant if necessary.

4. Install the radiator cover. Fill the storage tank with the recommended coolant and install the diversion cover.

THERMOSTAT

REMOVAL/INSTALLATION

Remove the following:

Drain the coolant remove the bolts [1] and thermostat cover [2].



Remove the thermostat from the cylinder head [1] The installation sequence is opposite to the removal sequence

TORQUE:

Thermostat cover bolt: 12 N.m (1.2 kgf.m, 9 lbf.ft)

NOTICE:

When installing the thermostat, pay attention to align with the exhaust hole, use the groove on the cylinder head to adjust the convex nail. The system fills and drains the coolant

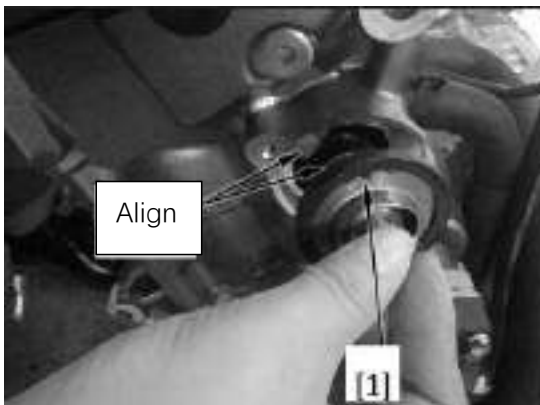
**INSPECTION**

Whether the thermostat [1] is damaged. If the thermostat valve is open at room temperature, it needs to be replaced. Check whether the sealing ring [2] is damaged, and replace it if necessary.

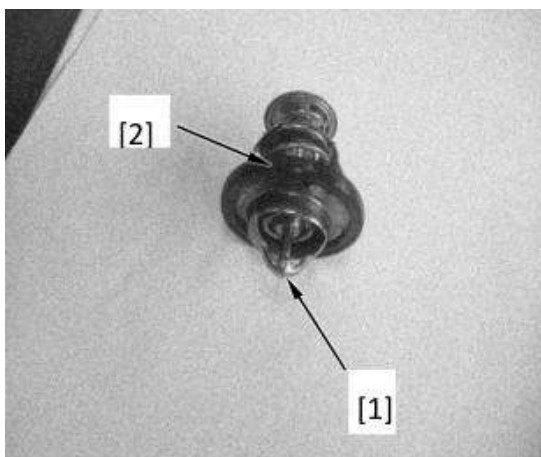
**NOTICE:**

Wear insulating gloves and proper eye protection. Do not let flammable materials contact the heating element. Do not let the thermostat or thermometer [1] touch the container, otherwise it will cause the reading to be wrong. Use the heating element to heat the water to the working temperature for 5 minutes. Hang the thermostat [2] in hot water and check its working condition.

THERMOSTAT BEGIN TO OPEN: 80-84°C (176-183°F)

VALVE LIFT: 95°C (203°F) minimum at 8 mm (0.3 in)

Replace the thermostat if it responds at temperatures other than those specified.

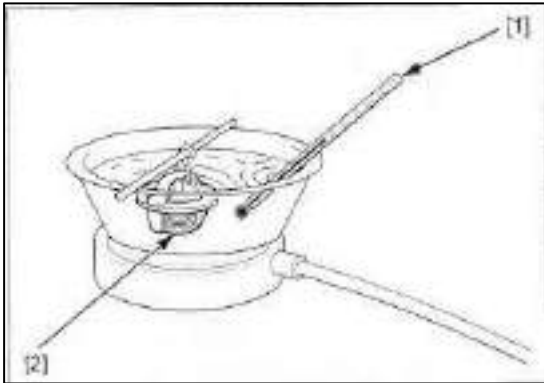

RADIATOR/COOLING FAN

REMOVAL/INSTALLATION

Drain the coolant, cut off the fan motor 2P (black) connector [1], and remove it from the original state. Remove the wire clamp from the fan motor shield [2].

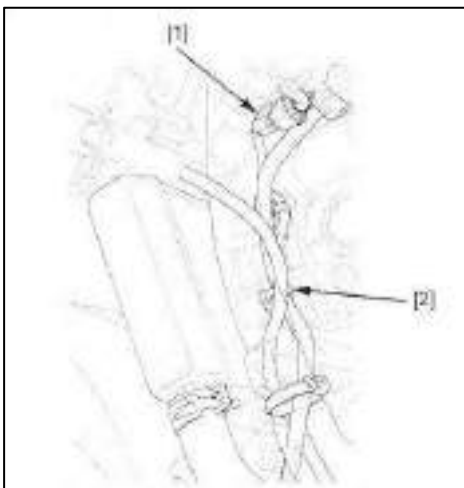

Loosen the pipe clamp [1] and loosen the hose on the radiator [2]. Loosen the siphon hose [3]. Loosen the pipe clamp [4] and loosen the hose under the radiator [5].

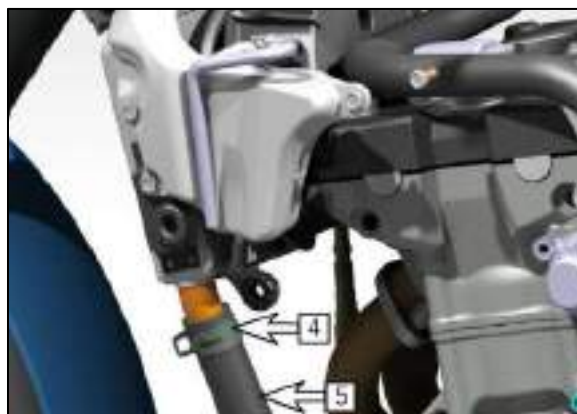

COOLING SYSTEM

Remove the assembly bolts and gaskets on the radiator [1]. Loosen the thermal protection rubber from the filling pipe, bend, and cable.



Be careful not to damage the radiator fins. Loosen the bushing ring [1] by moving the radiator to the left and remove the radiator [2]. The installation sequence is opposite to the removal sequence. The system fills and drains the cooling liquid.



DISASSEMBLY/ASSEMBLY

Disassemble and assemble the radiator as following illustration.

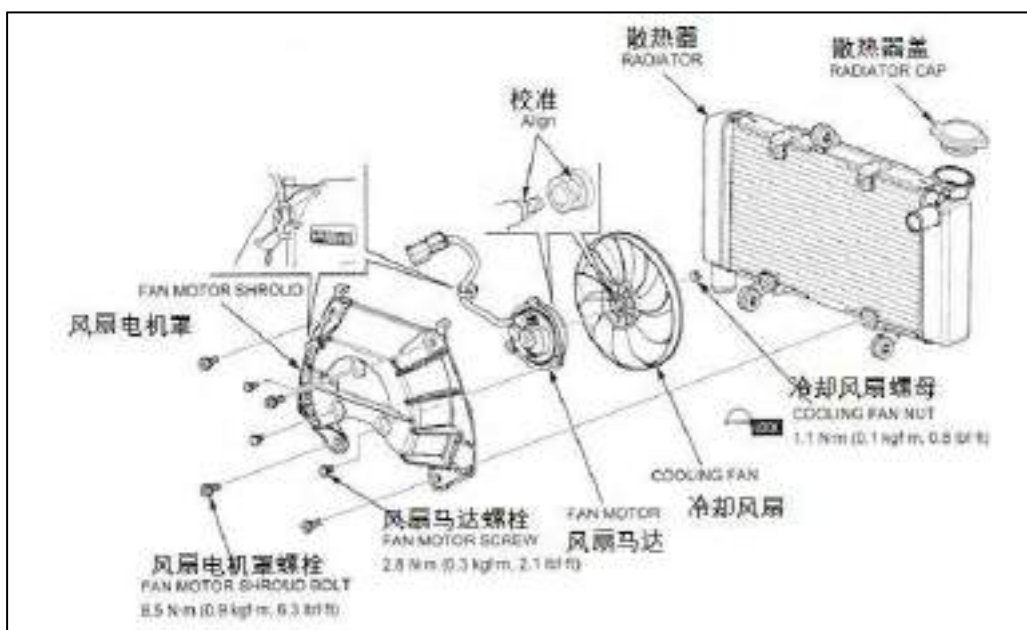

RADIATOR WATER TANK

REMOVAL/INSTALLATION

Remove the following:

- Fan motor guard
- Fans and motors

Remove the overflow pipe [1] from the lower vent cap. Remove the bolts [2], and remove the water tank [3]

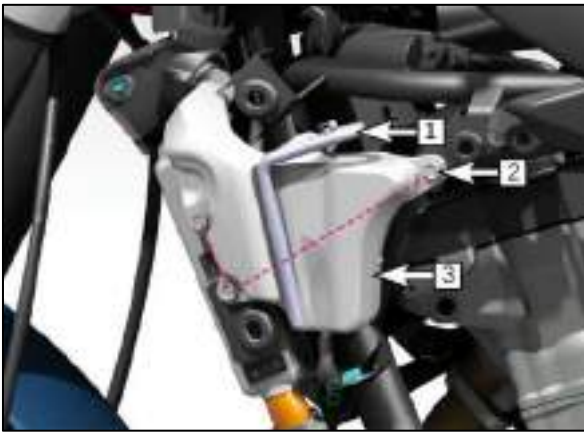

Loosen the siphon hose [1], drain the coolant, and remove the radiator water tank. Disconnect the overflow pipe [2] and remove the radiator water tank. The installation sequence is opposite to the removal sequence. Fill it with the recommended coolant Water tank.



WATER PUMP

Face seal inspection

Check the overflow hole of the pump [1] to confirm whether there is coolant leakage.

- a small amount of coolant outflow is normal.

- ensure no continuous coolant leakage when starting the engine.

Replace the pump as an assembly if necessary.



REMOVAL/INSTALLATION

NOTICE:

Place a clean oil pan under the engine. When the water pump body is removed, the organic oil will flow out. After installation, add the specified oil to the specified position (see the lubrication system maintenance guide for details). Drain the coolant and remove the drive sprocket cover, Keep the motorcycle upright on a level ground.

Loosen the pipe clamp [1], and loosen the following devices from the water pump:

- Small circulating water pipe [2]
- Cylinder body inlet pipe [3]



Remove the following:

- Water pump cover bolt [1]
- 3 assembly bolts [2]
- Drain bolt [3]
- Water pump cover [4]

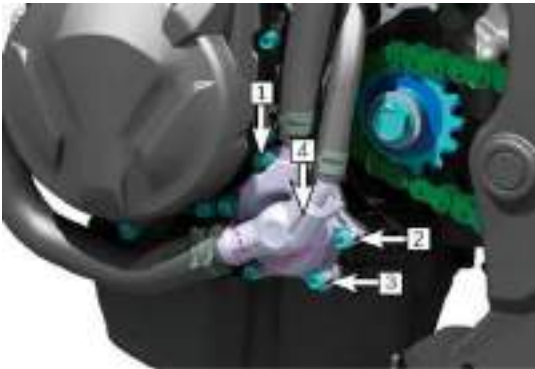

Remove the cover O-ring [1] from the water pump body. Remove the water pump body [2] from the crankcase.

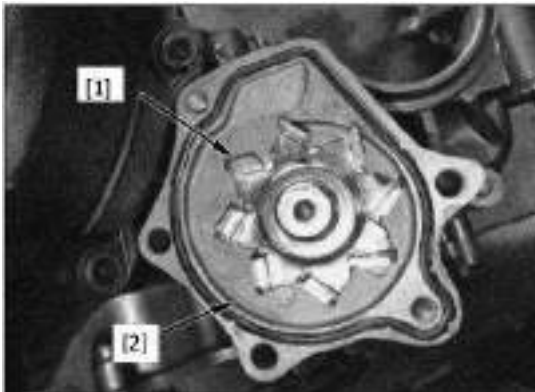

COOLING SYSTEM

Remove the water pump body O-ring [1]. Installation is in the reverse order of removal.

TORQUE:

Water pump mounting bolt: 12N.m (1.2kgf.m, 9 lbf.ft)

Water pump cover bolt: 10 N.m (1.0 kgf.m, 10 lbf.ft)

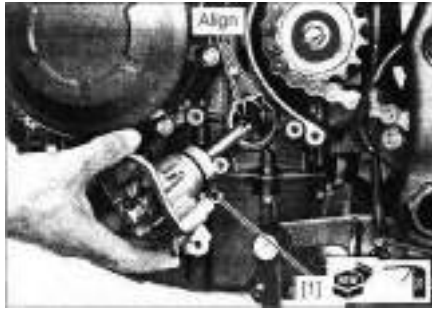
**NOTE:**

- Do not disassemble the water pump body.
- Replace the O-rings with new ones.
- Apply engine oil to the water pump body O-ring.
- Do not apply engine oil to the cover O-ring.
- Align the water pump shaft groove with the oil pump shaft end by turning the water pump impeller.

Check the oil level. Fill and bleed the cooling system.

WATER PIPE CONNECTOR

REMOVAL/INSTALLATION

Drain the coolant, remove the throttle valve/air filter assembly, loosen the pipe clamp [1], and remove the water inlet pipe [2]. Remove the nut [3], pipe joint [4] and O-ring [5]. The installation sequence is opposite to the removal sequence.

NOTICE:

Replace the O-ring with a new one. Fill and bleed the cooling system.

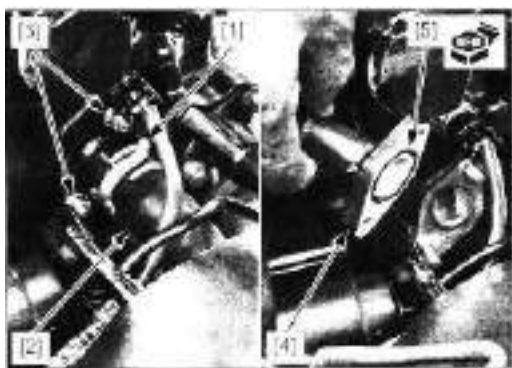

STUD BOLT REPLACEMENT

Remove the water hose connector, screw the nut on the two bolts, and tighten, and then use the wrench to unscrew the stud bolt. Use the new stud bolt locking device to install the stud bolt into the cylinder block, as shown in the figure. After the stud bolts are installed, check whether the length from the bolt head to the surface of the cylinder block is within the specified length.

SPECIFIED LENGTH: 15.0- 16.0mm

Install the water pipe joint

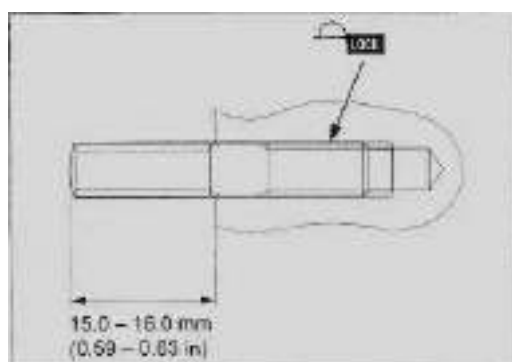

9.LUBRICATION SYSTEM

MAINTENANCE INFORMATION	9-1
TROUBLE SHOOTING	9-2
LUBRICATION SYSTEM	9-3
OIL PRESSURE INSPECTION	9-4
OIL PUMP	9-5
PRESSURE RELIEF VALVE	9-6
OIL STRAINER	9-7

MAINTENANCE INFORMATION

GENERAL



Used engine oil may cause skin cancer if repeatedly left in contact with the skin for prolonged periods. Although this is unlikely unless you handle used oil on a daily basis, it is still advisable to thoroughly wash your hands with soap and water as soon as possible after handling used oil.

- The oil pump can be serviced with the engine installed in the frame.
- The service procedures in this section must be performed with the engine oil drained.
- When removing and installing the oil pump, use care not to allow dust or dirt to enter the engine.
- If any portion of the oil pump is worn beyond the specified service limits, replace the oil pump as an assembly.
- After the oil pump has been installed, check that there are no oil leaks and that oil pressure is correct.
- For engine oil pressure indicator/EOP switch inspection.
- For piston oil jet service.

TROUBLE SHOOTING

Oil level too low

- Oil consumption.
- External oil leak.
- Piston rings are worn or not in place.
- Worn cylinders.
- Worn stem seals.
- Worn valve guide.

Low oil pressure

- Oil level low
- Clogged oil strainer
- Internal oil leak
- Incorrect oil being used

No oil pressure

- Oil level too low
- Oil pressure relief valve stuck open
- Broken oil pump drive chain
- Broken oil pump drive or driven sprocket
- Damaged oil pump
- Internal oil leak

Oil pressure is too high

- Hydraulic safety valve is closed
- Oil filter, oil return hole, oil measuring hole blocked
- Improper use of oil

Oil pollution

- The oil and filter are not changed regularly
- The piston ring is damaged

Engine oil emulsification

- Cylinder head cover expansion and cracking
- Leakage of coolant channel
- Water has entered the engine

LUBRICATION SYSTEM DIAGRAM

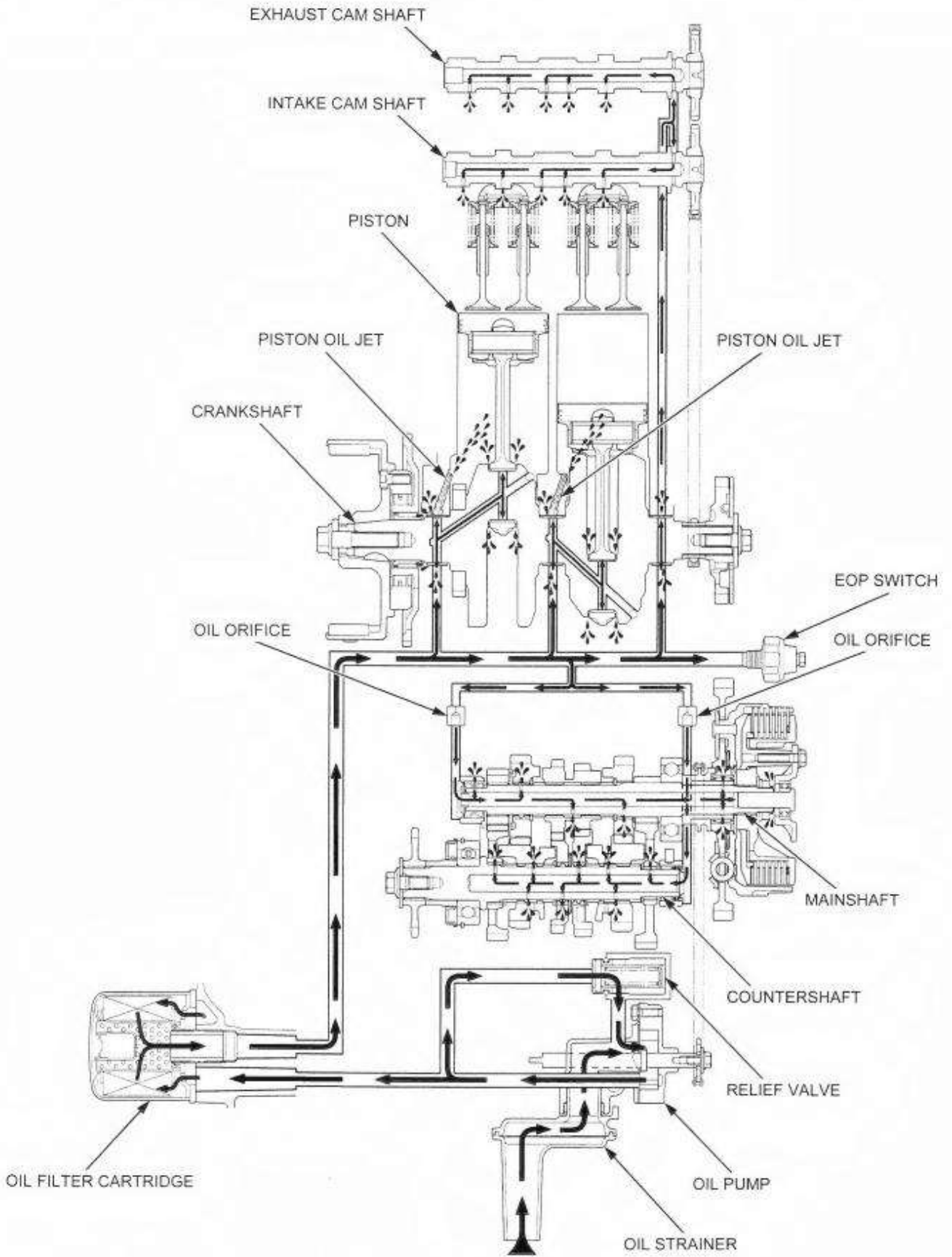

OIL PRESSURE INSPECTION

NOTE:

When the engine is running, if the engine oil pressure gauge keeps on, check the pressure gauge system before checking the oil pressure. Remove the oil pressure sensor.

Install the oil pressure measuring instrument buffer [1] into the switch base.

Connect the oil pressure measuring instrument [2] with the instrument buffer.



TOOL:

Oil pressure measuring instrument

Oil pressure gauge buffer

Check the oil level and add the recommended oil if necessary.

Warm the engine to normal operating temperature (approximately 80°C/176°F) and increase the engine speed to 1,200 rpm and read the oil pressure.

STANDARD:

At 1200rpm/80 °C, the reading is: 93kPa (0.9kgf/cm², 13psi)

Turn off the engine, remove the tool. Install the oil pressure sensor.

OIL PUM

REMOVAL/INSTALLATION

Disassemble the clutch, remove the bolt [1] and the oil pump [2]

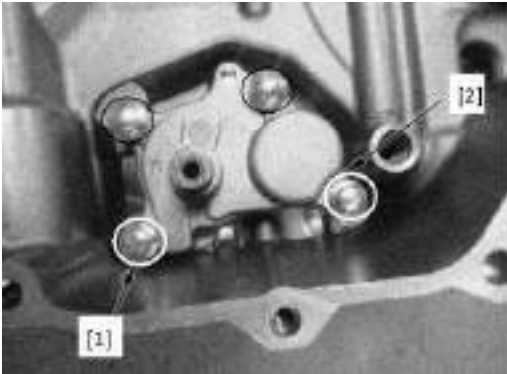

Installation is in the reverse order of removal.

NOTICE:

Align the oil pump shaft end with the water pump shaft groove.

DISASSEMBLY/ASSEMBLY

Disassemble and assemble the oil pump as following illustration:

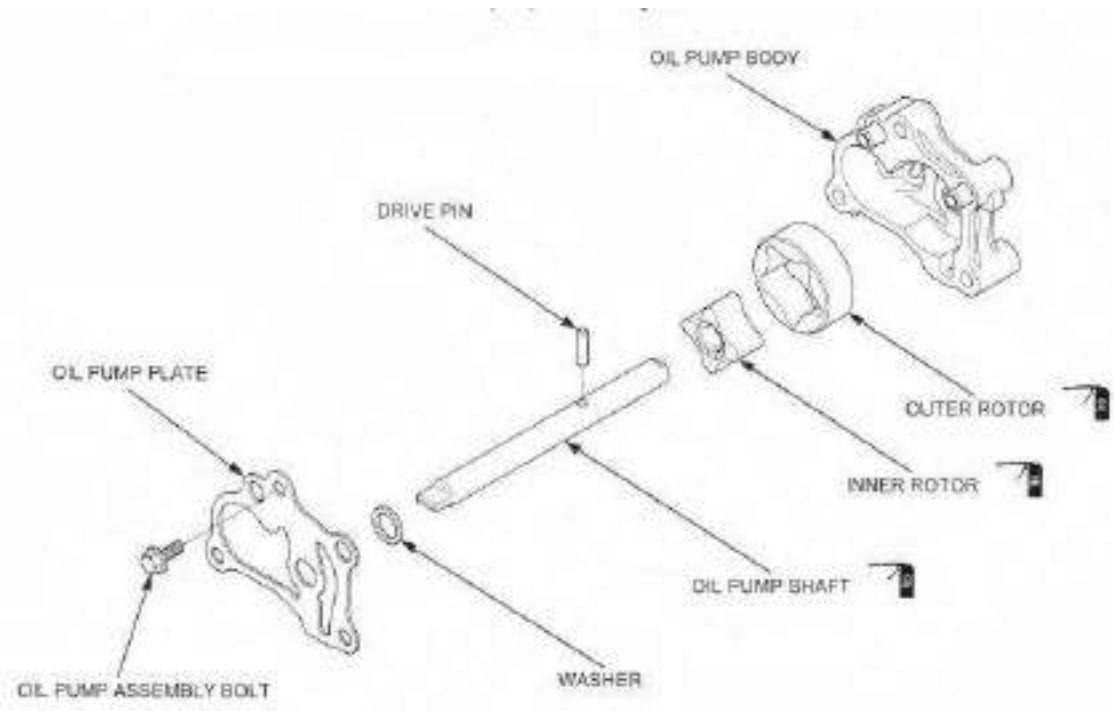

INSPECTION:

- For oil pump drive sprocket, driven sprocket and drive chain inspection.

Inspect the following parts for damage, abnormal wear, deformation or burning.

- oil pump shaft
- drive pin
- inner rotor
- outer rotor
- oil pump body

Measure the oil pump clearance according to the specifications of the lubrication system. If any measured value exceeds the specified maintenance limit value, please replace the entire oil pump assembly.

PRESSURE RELIEF VALVE**REMOVAL/INSTALLATION**

Remove the oil pump, remove the pressure relief valve [1] and O-ring [2]. Replace with a new O-ring. Install the O-ring into the pressure relief valve groove. Install the pressure relief valve into the crankcase groove. Installation Oil pump

**INSPECTION**

Check the operating condition of the pressure relief valve by pushing the control valve push rod [1].

Remove the elastic retaining ring [2] to disassemble the pressure relief valve.

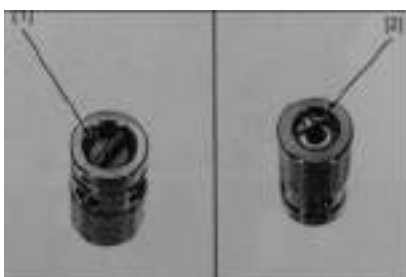

LUBRICATION SYSTEM

Remove the washer [1], spring [2], piston [3]. Check whether the control valve push rod is worn, scratched, or damaged. Check whether the spring is fatigued or damaged. The installation sequence of the pressure relief valve is the opposite of the decomposition sequence.

NOTE:

- When installing the circlip, the chamfered side faces outward.
- Ensure that the retaining ring is installed in the groove.

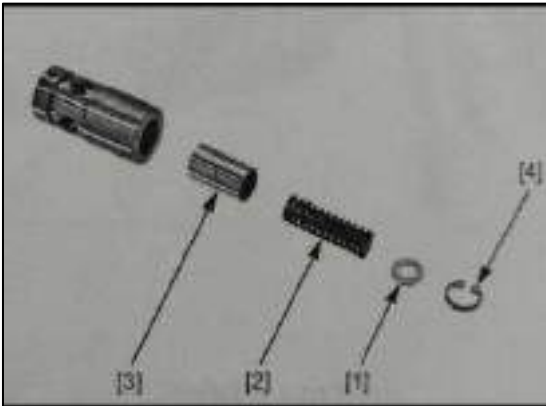
**OIL STRAINER**

Drain the oil. Remove the exhaust pipe. Remove the drain pipe clamp [1] from the bottom shell.

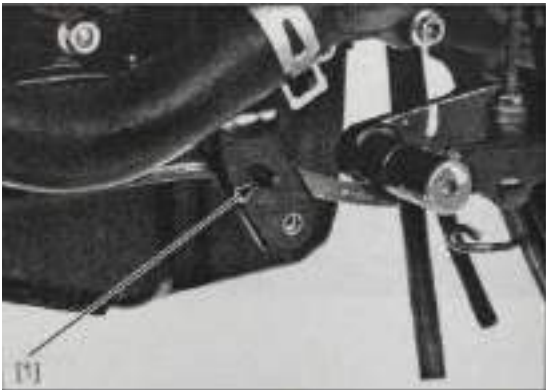

Remove the oil pan bolt [1] diagonally, and remove the oil pan and gasket at position [2].



Remove the oil filter [1] and the sealing ring [2]. Clean the filter net [3] and check for damage.

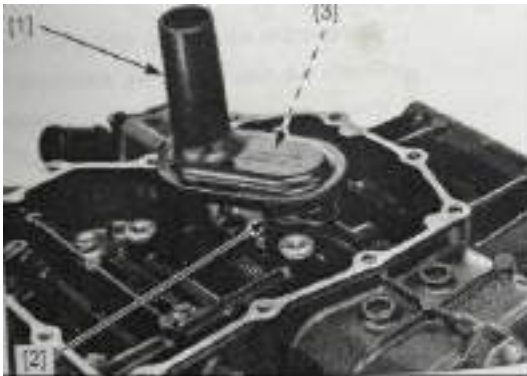

INSTALLATION

NOTICE: Do not damage the installation surface and clean the gasket on the installation surface of the oil pan. Replace with a new sealing ring [1] and install it on the filter [2]. Install the filter into the crankcase, pay attention Align the convex shaft on the filter with the groove on the crankcase.



Replace the new gasket [1] and install the oil pan [2]. Install the oil pan and bolts [3] on the crankcase body. Tighten the bolts in diagonal order.

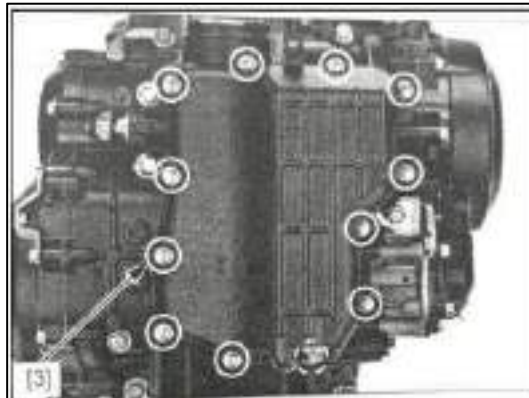
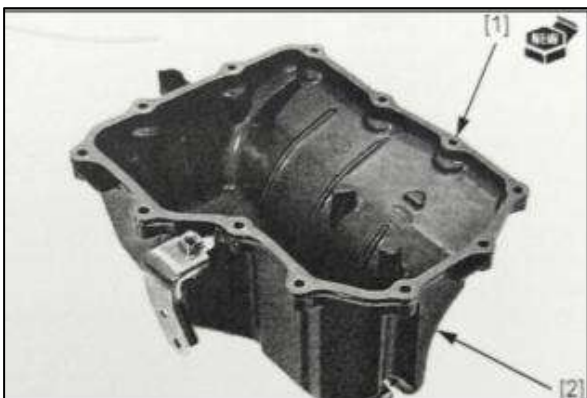

LUBRICATION SYSTEM

Install the drain pipe bracket [1]. Install the drain pipe. Add recommended oil to the engine and check for inorganic oil leakage.



10. CYLINDER HEAD/VALVES

MAINTENANCE INFORMATION	10-1
TROUBLESHOOTING.....	10-3
COMPONENT LOCATION	10-4
CYLINDER COMPRESSION TEST.....	10-5
CAM SHAFT	10-9
CAMSHAFT OIL SYSTEM	10-12
ROCKER ARM	10-16
CYLINDER HEAD	10-18
TENSIONER ADJUSTING SCREW.....	10-26
TIMING CHAIN/SPROCKET	10-27

MAINTENANCE INFORMATION

GENERAL

- This section covers service of the cylinder head, valves, rocker arms and camshafts.
- The rocker arms, camshafts and cam chain tensioner lifter services can be done with the engine installed in the frame. The cylinder head and valve service requires engine removal.
- When disassembling, mark and store the disassembled parts to ensure that they are reinstalled in their original locations.
- Clean all disassembled parts with cleaning solvent and dry them by blowing them off with compressed air before inspection.
- Camshafts and rocker arms lubricating oil is fed through oil passages in the cylinder head and camshaft holder. Clean the oil passages before assembling them.
- Be careful not to damage the mating surfaces when removing the cylinder head cover and cylinder head.

TROUBLESHOOTING

The top fault of the engine usually affects the performance of the engine. These faults can be diagnosed through the compression test,

You can also use a probe rod or stethoscope to trace the source of engine noise, and the tracing range can reach the top tip.

If the engine performance is not good when running at low speed, please check whether there is white smoke in the crankcase breather pipe.

The hose is smoking, please check if the piston ring is stuck.

When the engine is running at low speed, the compression pressure is too low, it is difficult to start or the performance is poor

- Valves
 - Incorrect valve clearance adjustment
 - Burned or bent valve
 - Incorrect valve timing
 - Broken valve spring
- Cylinder head
 - Leaking or damaged cylinder head gasket
 - Warped or cracked cylinder head
 - Loose spark plug
- Worn cylinder, piston or piston rings

Compression too high, overheating or knocking

- Excessive carbon build-up on piston crown or on combustion chamber.

Excessive smoke

- Cylinder head
 - Worn valve stem or valve guide
 - Damaged stem seal
- Worn cylinder, piston or piston rings

Excessive noise

- Cylinder head
 - improper adjustment of valve clearance
 - valve stuck or valve spring broken
 - camshaft worn or damaged
 - worn rocker arm or rocker shaft
 - worn rocker arm and valve stem ends
 - the CAM chain is loose or worn
 - worn timing chain
 - Worn cam sprocket teeth
- Worn cylinder, piston or piston rings

Rough idle

- Low cylinder compression

CYLINDER HEAD/VALVES

COMPONENT LOCATION

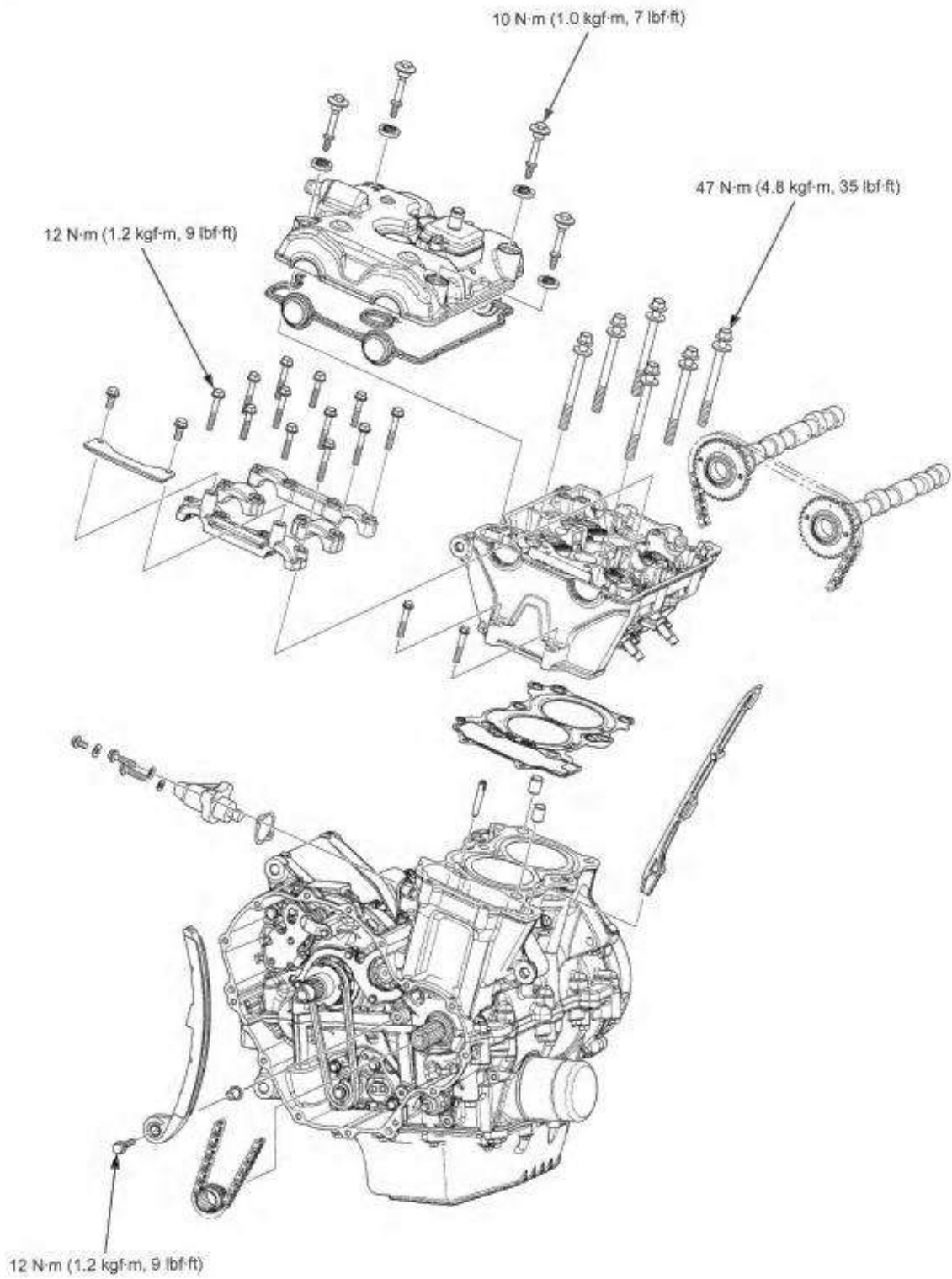

CYLINDER COMPRESSION TEST

Heat the engine to normal operating temperature. Stop the engine and remove the spark plug.

Temporarily install the wiring harness of the ECU. Connect the 33 (black) connector.

Install the threaded end of the cylinder pressure gauge [1] into the spark plug hole.

TOOL:

[2] Compression instrument buffer



Turn the ignition switch to the "O" position, and the engine switch to the gear position to neutral.

Open the maximum throttle and start the engine until the pressure gauge reading no longer rises. The maximum reading usually lasts 4-7 seconds.

Compression pressure:

At 450rpm, 1372kPa

Low compression can be caused by:

- Blown cylinder head gasket
- Improper valve clearance adjustment
- Valve leakage
- Worn piston rings or cylinder

High compression can be caused by:

- Carbon deposits in combustion chamber or on piston head

CYLINDER HEAD COVER

REMOVAL/INSTALLATION

NOTICE:

Maintenance of the cylinder head cover does not need to remove the engine from the frame.

Remove the fuel tank under the pallet.

Remove the following parts :

- Remove the plug of the secondary air supply valve [1]
- Remove the secondary air intake pipe [2]
- Remove the snorkel [3]
- Fuel evaporation control system [4][5]



Remove the bolt [1], the clutch brace positioning plate, and remove the clutch cable [4] from the clutch cable hanger [3]. Move the clutch cable out of the frame.

Loosen the throttle cable adjuster lock nut A[1] and adjuster [2], and then loosen the throttle cable A[3] from the throttle drum and cable bracket. Loosen the throttle cable adjuster B[4], then loosen the throttle cable B[5] from the throttle drum and cable bracket. Move the throttle cable out of the frame.

Remove the mounting bolt on the radiator. Remove the bolt [6] and Brake cable connector [7]. Remove the Brake tube [9] from the two wire clamps [8], and remove the wire clamp from the frame.

Fuel evaporation system:

Remove the carbon canister mounting bolt [1] and washer [2], and remove the carbon canister [3].

Remove the bolt [4] and connecting cable [5].

CYLINDER HEAD/VALVES

Fuel evaporation system:

Remove the evaporative emission control solenoid valve from the frame.

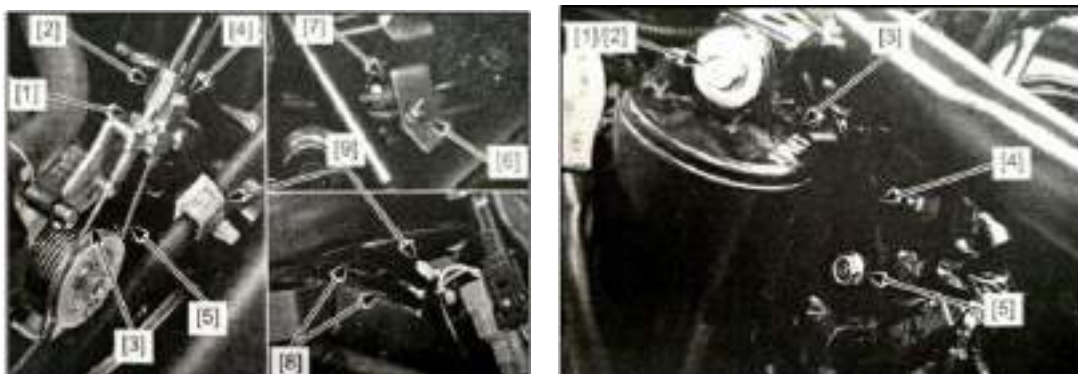

Loosen the overflow pipe [2] from the pipe clamp [1]. Remove the insulating rubber sheet [3] except for the overflow pipe, and place it on the right side of the frame.

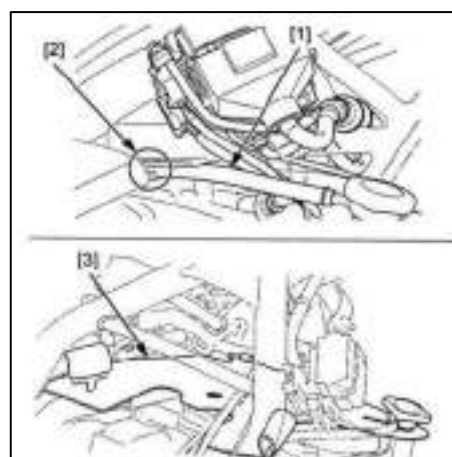

Remove the secondary air supplement pipe joint bolt [4], remove the pipe joint [5] from the cylinder head cover, remove the two reed valves [6], and remove the two fire nets [7].

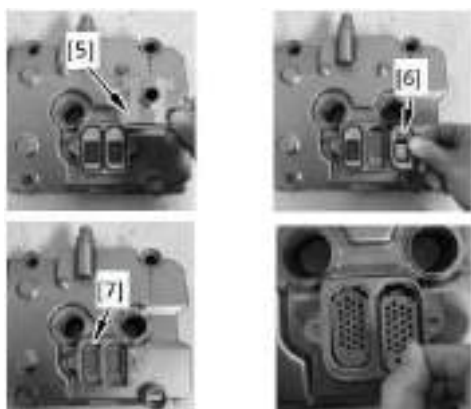

NOTICE:

Do not forcibly remove the positioning pin [8] of the cylinder head cover. The positioning pin is an interference fit.

The installation direction of the fire net and reed valve is as shown in the figure, and cannot be installed violently.

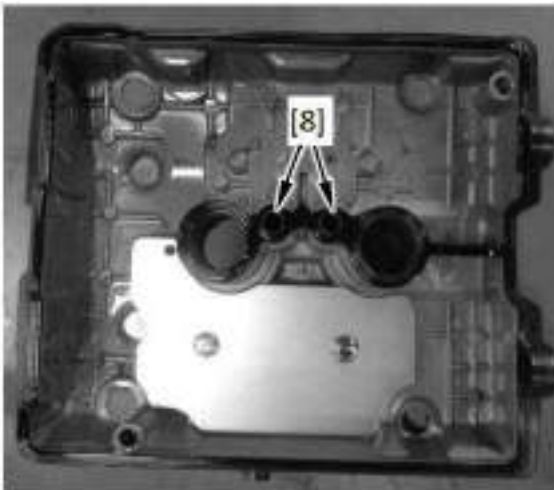
**INSPECTION:**

Whether the reed of the reed valve returns to the normal position.



Remove the cylinder head cover seal ring from the cylinder head cover.

The installation sequence is opposite to the removal sequence.

TORQUE:

Cylinder head cover bolt: 10N·m

Right crankcase cover bolt: 10N·m

NOTE:

Replace the cylinder head cover sealing ring with a new one.

When installing, pay attention to install the cylinder head cover seal ring into the cylinder head cover groove. Align the hole of the clutch brace positioning plate with the boss on the crankcase.

Adjust the following:

- throttle grip freeplay
- clutch lever freeplay

CAMSHAFT

NOTE:

When servicing the camshaft, there is no need to remove the engine from the frame. Remove the cylinder head cover. Make sure that the first cylinder piston is at the top dead center of the compression stroke. Remove the sealing bolt [1] and the sealing washer [2]. Use the tool to retract the tensioner adjusting screw completely (clockwise).



[3] Tensioner holder B

NOTE:

Be careful not to drop the chain limit plate bolts into the crankcase. Remove the bolts [1] and chain limit plate [2].



NOTE:

From the outside to the inside, loosen the camshaft bracket bolts alternately several times, otherwise the camshaft bracket will be easily damaged. Be careful to prevent the camshaft bracket bolts from falling into the crankcase. Divide 2 to 3 times and loosen the camshaft bracket bolts alternately [1], and remove. Remove the camshaft bracket [2] and the positioning pin from the cylinder block.

CYLINDER HEAD/VALVES

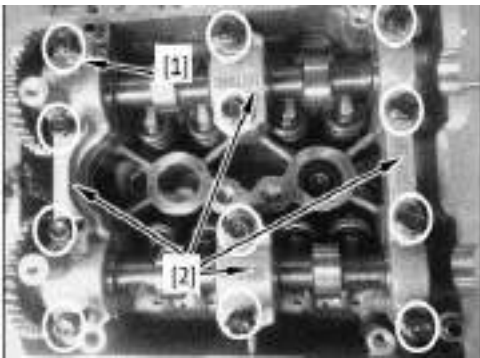

NOTE:

Do not forcibly remove the positioning pin from the camshaft bracket. Hang the cam chain with a wire to prevent it from falling into the crankcase. Remove the chain [1] from the sprocket, and remove the camshaft [2]

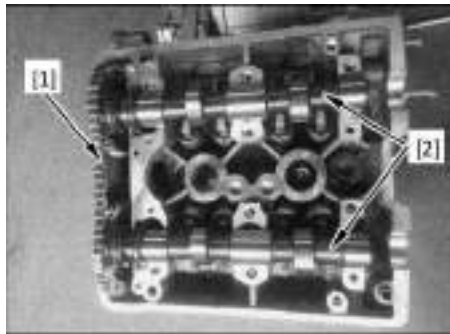

NOTE:

Be careful to prevent the valve adjusting gasket from falling into the crankcase.

Mark the gasket to ensure that it is in the original position during installation.

The gasket is easier to remove with tweezers or magnets.

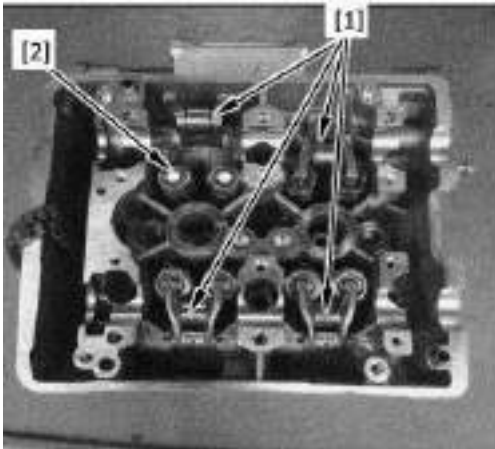

INSPECTION

Inspect the following parts for damage, abnormal wear, deformation, burning or clogs in oil passages.

- cam sprockets/camshafts
- camshaft holders/dowel pins
- CAM chain clamp

Measure each part according to cylinder head / / valve specification.

Camshaft pulsates

Fix the two ends of the camshaft with a v-block and use a scale.

Measure the beat

SERVICE LIMIT: 0.04mm

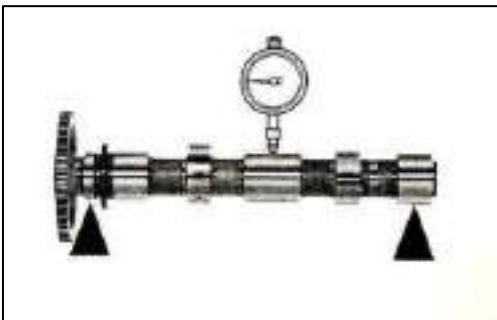

CYLINDER HEAD/VALVES

CAMSHAFT OIL CLEARANCE

Wipe off the oil on the camshaft, cylinder head, and camshaft bracket.

Install the camshafts onto the cylinder head.

- Align the machine mark [2] on the intake CAM sprocket [1] with the surface of the cylinder head, as shown in the figure.

- Align the "EX" mark [4] on the exhaust camshaft [3] with the surface of the cylinder head, as shown in the picture.

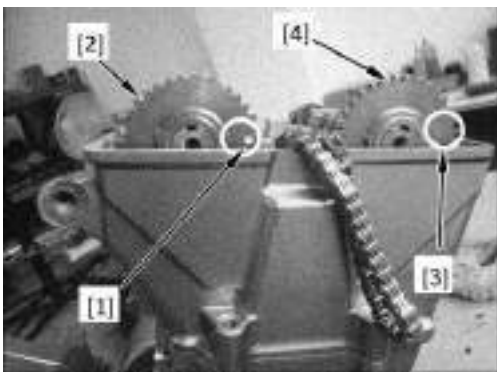

A plastic line clearance gauge [1] is placed longitudinally on the top of the cam journal, taking care to avoid oil holes.

NOTE:

Do not rotate the camshaft during inspection

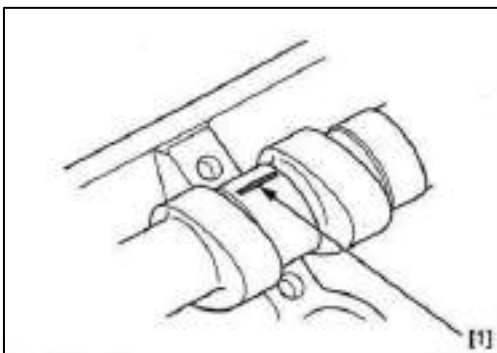

Be sure the dowel pins in the camshaft holder align with the holes in the cylinder. Install each camshaft bracket in the corresponding position and make sure the arrow [1] points to the intake side, as shown in [2] the figure.

- camshaft holder A [2]
- camshaft holder B [3] ("IN" mark: intake side holder)
- camshaft holder C [4] ("EX" mark: exhaust side holder)

— camshaft holder D[5]

Pay attention to the camshaft support bolt thread and sealing surface oil.

Camshaft support bolt:

— 6×39.5mm bolt[1]

— 6×32mm bolt[2]

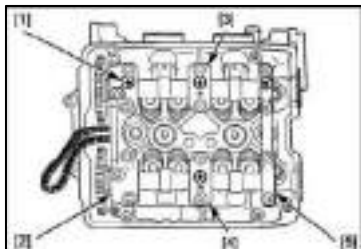

NOTE:

From the inside to the outside, tighten the camshaft bracket bolts in several staggered intervals, otherwise the camshaft bracket will be easily damaged. From the inside to the outside, tighten the camshaft bracket bolts in staggered intervals until the camshaft bracket is installed in place. Stagger the camshaft bracket bolts to the specified torque value 3 times.

TORQUE: 12N ·m

拆下凸轮轴支架，并测量每个塑性线间隙规的宽度.最宽厚度决定油隙.



维修界限值: 0.10m

When the maintenance limit value is exceeded, replace the camshaft and re-check the oil gap. If the oil gap still exceeds the maintenance limit value, replace the camshaft bracket and cylinder head as a group at the same time.



INSTALLATION

NOTE:

When turning the crankshaft, do not force the cam chain into the timing sprocket. Turn the crankshaft clockwise to align the "T" mark [1] on the primary driving gear with the index mark [2] on the right crankcase cover.

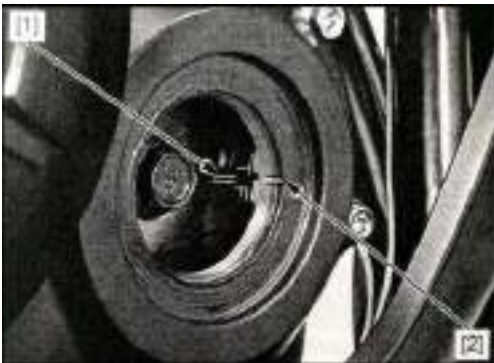

NOTE:

Be careful to prevent the valve adjusting shim from falling into the crankcase. Install the valve adjusting shim [1] to the original position on the valve seat in turn. Lower the rocker shaft [2].

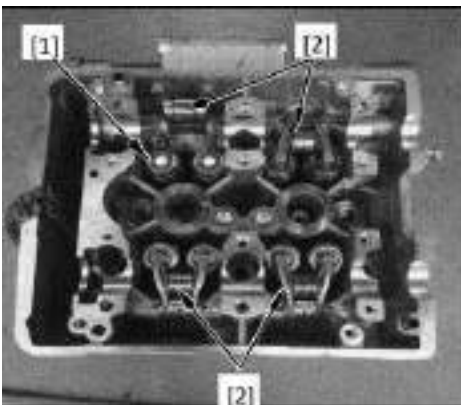

Each camshaft has an identification mark: · "IN" mark [1]: intake camshaft · "EX" mark [2]: exhaust camshaft



CYLINDER HEAD/VALVES

Apply molybdenum disulfide solution to the camshaft cam[1], journal and bearing surface. Apply oil to the entire surface of the cam chain[2]. Install the cam chain with the cam sprocket, and install the camshaft on the cylinder head Up. Move the punching mark [3] on the cam sprocket upward, and align the lower marks of the "IN" mark [4] and the "EX" mark [5] with the upper surface of the cylinder head, as shown in the figure.

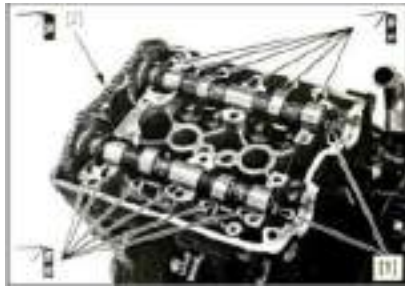

Ensure that the locating pin on the camshaft support is aligned with the pin hole on the head of the cylinder. Also ensure that all arrows on the camshaft support point to the intake side. Install each camshaft bracket in the corresponding position and make sure the arrow [1] points to the intake side, as shown in the figure.

- camshaft holder A[2]
- camshaft holder B[3] (“IN” mark: intake side holder)
- camshaft holder C[4] (“EX” mark: exhaust side holder)
- camshaft holder D[5]

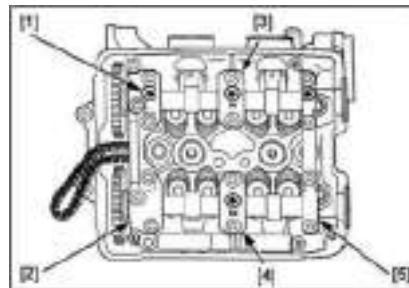

Be careful not to let the cam chain guide bolts fall into the crankcase.

Camshaft support bolt

- 6×39.5mm bolt[1]
- 6×32mm bolt[2]



CYLINDER HEAD/VALVES

From the inside out, tighten the camshaft bracket bolts alternately several times, otherwise the camshaft bracket will be easily damaged. From the inside out, tighten the camshaft bracket bolts alternately several times until the camshaft bracket is in place.

Stagger the camshaft bracket bolts to the specified torque value in 2-3 times. Install the cam chain pressure plate [1], and pay attention that the "EX" mark [2] faces the exhaust side.

NOTE:

Be careful to prevent the cam chain pressure plate bolt from falling into the crankcase. Install and tighten the cam chain pressure plate bolt [3].

TORQUE: 12N.m



Remove the tensioner [1] from the tension adjustment screw. Turn the crankshaft clockwise several times, and then align the "T" mark on the primary driving gear with the index mark on the right crankcase cover. Recheck the valve timing. Check the valve clearance. Install the sealing bolt [1], pay attention to replace the new gasket [2]. Install the cylinder head cover.



ROCKER ARM

REMOVAL/INSTALLATION

NOTE:

When servicing the rocker shaft, there is no need to remove the engine from the frame.

The maintenance steps of the intake valve and exhaust valve rocker shaft are the same.

Remove the camshafts.

Remove the plug bolt [1] and sealing washer [2].



Fix the rocker arm [1], then remove the rocker arm shaft [3] with a 6mm bolt [2].

Remove the rocker arm. Apply molybdenum disulfide solution to the sliding area, force surface and outer surface of rocker arm shaft. Install rocker arm and rocker arm shaft.

NOTE:

- The rocker arms are identified by the stamped marks:
 - “I” mark [4]: intake rocker arm
 - “E” mark [5]: exhaust rocker arm

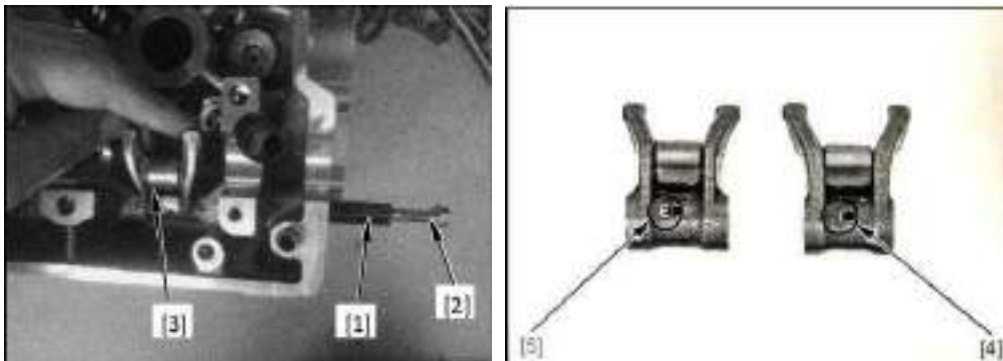

Install the pin bolt [1], pay attention to the thread oil and replace the new gasket [2], align the blade with the groove. Tighten the pin bolt to the specified torque.

TORQUE: 15N ·m

Install the camshaft.

INSPECTION

Check whether the following parts are damaged, abnormally worn, deformed, burnt or blocked in the oil passage.

CYLINDER HEAD/VALVES

- rocker arms
- rocker arm shafts

Measure each part and clearance according to CYLINDER HEAD/ALVES SPECIFICATIONS.
Replace any part if it is out of service limit.

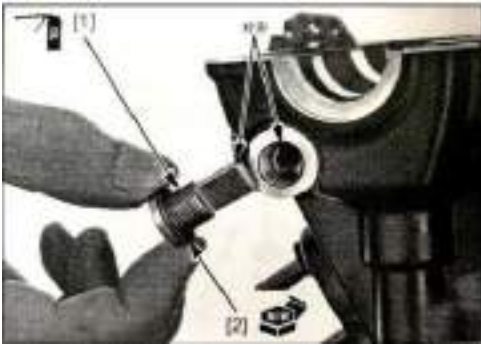

CYLINDER HEAD

REMOVAL

Remove the following:

- engine
- rocker arms
- thermostat

Loosen the pipe clamp [2] and remove the small circulating water pipe [3].



Remove the 6mm bolt [1]. Before removing the bolt, suck out the oil in the 9mm lever head bolt groove.

Loosen the 9mm cylinder head bolts [2] alternately in 2-3 times, and then remove the bolts. Remove the cylinder head [3].

NOTE:

Hook the CAM chain with wire to prevent it from falling into the crankcase.

CYLINDER HEAD/VALVES

Do not knock the cylinder head too much and do not damage the binding surface by using any tool as a lever.

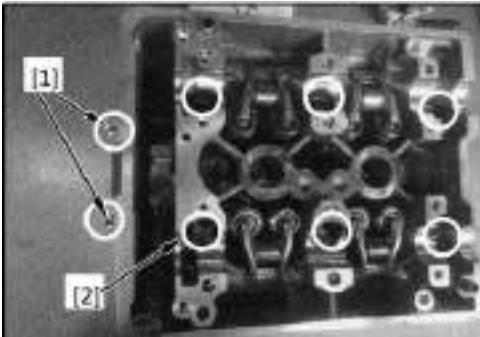

Remove locating pin [1] and gasket [2].



Remove the chain guide plate [1].

Remove the water-proof rubber rod [1].

Check whether the waterproof rubber rod is deteriorated or damaged.



Remove the following:

- spark plugs
- Water temperature sensor

Note: to prevent permanent deformation of the valve spring, do not compress the spring too much during disassembly.

Remove the air lock clip with a special tool [1].

CYLINDER HEAD/VALVES

When disassembling, pay attention to mark each part for easy installation.

Remove the valve spring compression tool and the following parts:

- Upper valve spring seat ring[1]
- Outer valve spring[2]
- Inner valve spring[3]
- Valve [4]
- Oil guard[5]
- Lower valve spring seat [6]

Be careful not to damage the joint surface of the cylinder block and the surface of the valve seat. Clean the carbon deposits in the combustion chamber and the surface of the cylinder head gasket.

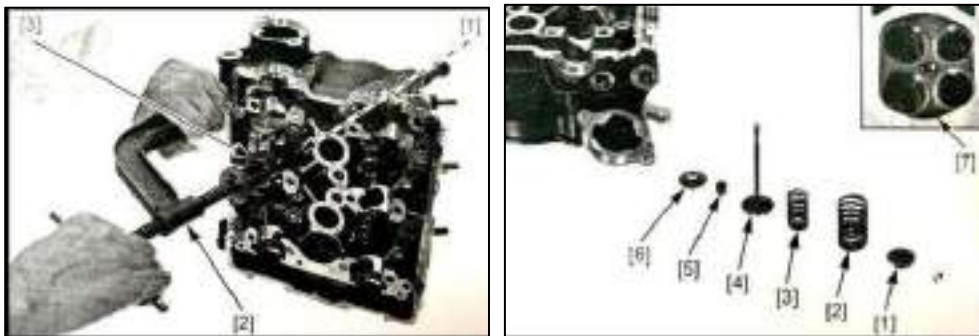

INSPECTION

Check whether the following parts are damaged, abnormally worn, deformed, burnt or blocked in the oil passage.

- Cylinder head
- Inner/outer spring
- Valve
- valve guide
- Chain guide plate

CYLINDER HEAD/VALVES

Measure each part and clearance according to the cylinder head//valve specifications.

If any component exceeds the maintenance limit value, replace it.

Before measuring the catheter, use a valve guide reamer to clean the carbon deposits in the catheter.

Please refer to valve seat inspection.

VALVE GUIDE REPLACEMENT

Disassemble the cylinder head. Cool the new valve guide in the freezer for one hour.

Notice:

·Be careful to wear heat-insulating gloves to avoid burns when operating the hot cylinder head.

Warping will occur when the cylinder head is heated with a torch. Use a hot plate or oven to heat the cylinder head to 130-140°C. Use a temperature indicator rod to ensure that the cylinder head is heated to a suitable temperature. The temperature indicator rod can be purchased from a welding supply store .Support the cylinder head, and push the valve guide and guide clamp out of the cylinder head from the direction of the combustion chamber.

TOOL:

Valve guide driver: , 4.5mm

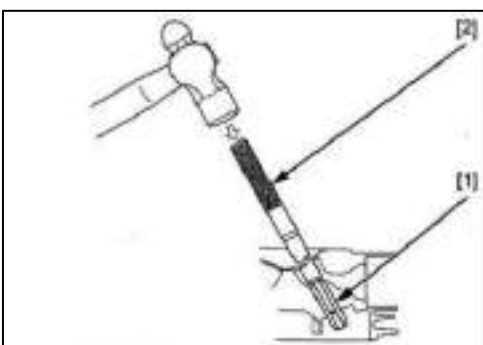

Take out new valve guides [1] from the freezer. While the cylinder head is still heated, drive new valve guides from the camshaft side until the exposed height is specified value.

CYLINDER HEAD/VALVES

Installation requirements:

Mark the depth of the valve guide with a marker. Use the valve guide driver to adjust the correct depth. Let the cylinder head cool to room temperature. Use a reamer to adjust the new valve guide after installation.

**NOTE:**

When reaming, be careful not to tilt or tilt the reamer inside the valve guide. Note the use of cutting oils during this operation. Insert the reamer from the combustion chamber of the cylinder head and always turn the reamer clockwise

TOOL:

Valve guide reamer, 4.5mm

Clean the cylinder head thoroughly to remove metal debris after reaming and trim the valve seat.

VALVE SEAT INSPECTION/REFACING INSPECTION

Disassemble the cylinder head cover. Thoroughly remove the carbon deposits on the intake/exhaust valves. Apply a thin layer of iron blue to each valve. Use a hand tool toward the valve seat. [1] Knock the valve lightly, and don't make the valve rotate. In case, check the contact of the valve seat.

Remove the valve and check the width of the valve seat surface. The contact surface width of the valve seat should be within the specified range, and the valve seat should be flat.

STANDARD: 0.90–1.10mm

SERVICE LIMIT: 1.5mm

If the valve seat width is not within the specified range, the valve seat needs to be trimmed. The valve cannot be polished. If the valve contact surface is ablated or severely worn, or the valve seat is uneven, replace the valve. Check the valve seat surface for the following conditions:

- The valve seat contact surface is uneven
- Bend or fold the valve stem, replace the valve and refit the valve seat.
- Seat wear
- Replace the valve and refit the valve seat.
- Contact area (too high or too low)
- Replace the valve seat.

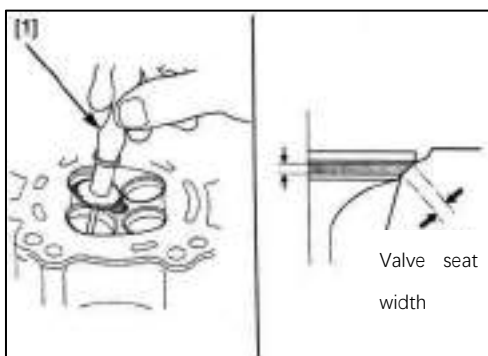

CYLINDER HEAD/VALVES

ASSEMBLY

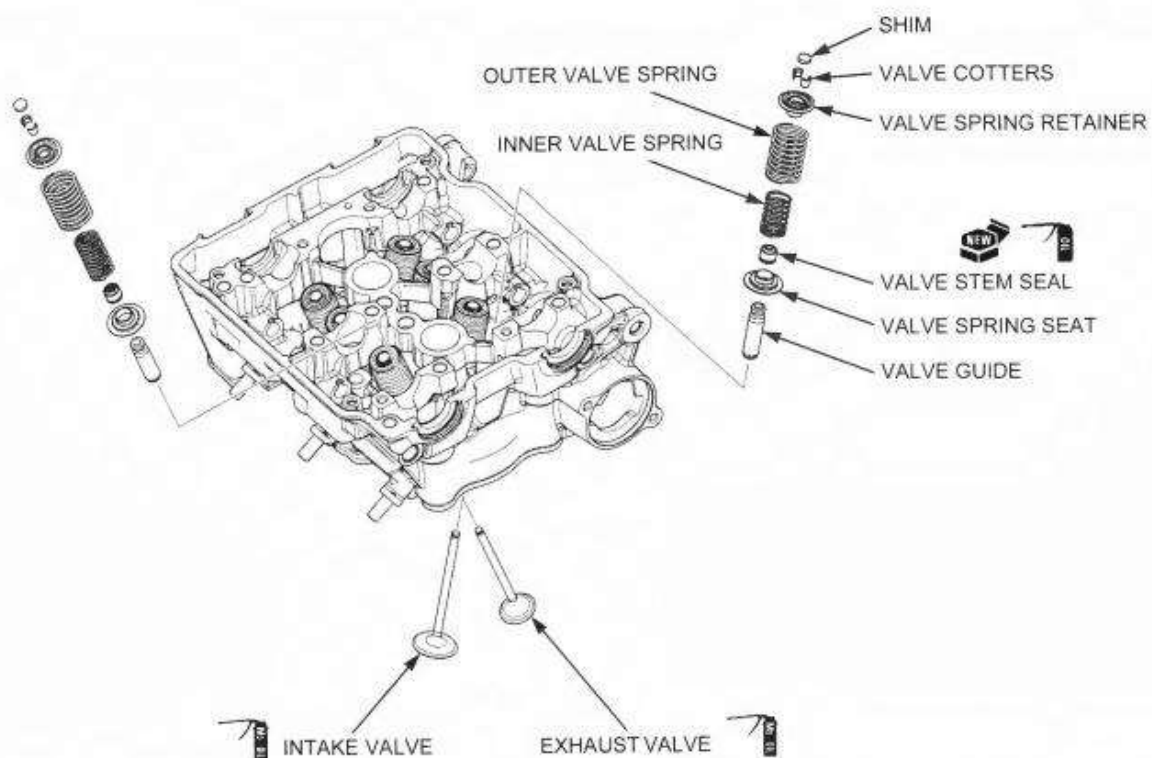

Clean the cylinder head assembly with solvent and flush all oil passages with compressed air.

Lubricate the new oil baffle cover with engine oil [1]. Install the lower valve spring seat [2] and the oil baffle cover. Lubricate the valve stems with molybdenum disulfide solution The sliding surface and rod end of the valve. Insert the valve [3] into the valve guide, and rotate the valve slowly during insertion to prevent damage to the oil baffle. Install the inner valve spring [4] and the outer valve spring [5] to make the coil dense One side faces the combustion chamber. Install the valve spring seat ring [6]. Use a special tool to install the valve lock clip [1]. Lubricate the split pin to reduce installation resistance. To prevent the spring from losing its elasticity, do not over-press the spring.

Set up the cylinder head on the workbench to prevent damage to the valve. Put the appropriate tool [1] into the valve guide [2]. Tap the tool lightly to securely install the lock clip.

Install the following components:

- Water temperature sensor
- Spark plug

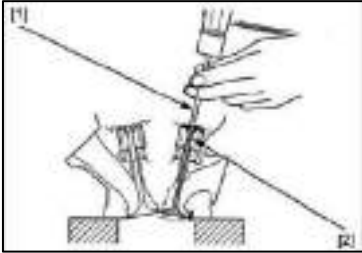

Install and remove the gasket material on the cylinder joint surface.

NOTE:

Do not allow dust and scum to enter the cylinder. Install the water-proof rubber rod [1] into the right side of the cylinder head on the intake side, with the cone facing down, and align the flange with the cylinder water jacket. The flange can be on the right side and left.

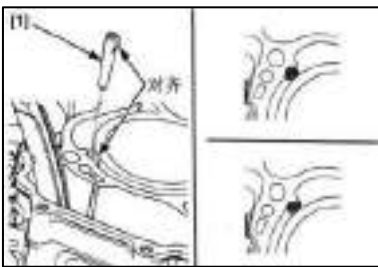

Install the chain guide plate [1] so that its protruding part is aligned with the groove on the cylinder, and its bottom is in the groove of the crankcase.



Install the positioning pin [1] and the new gasket [2].



CYLINDER HEAD/VALVES

Pass the timing chain through the cylinder head and install the cylinder head [1] onto the cylinder.

Thoroughly clean the threads and seat surface of the cylinder head seal bolt (9mm) and wipe dry. Apply engine oil to the cylinder head seal bolt (9mm) Install the cylinder head sealing bolts (9mm) [2] alternately in 2-3 times, and tighten them to the specified torque.

TORQUE: 47N ·m m

Install and tighten the 6 mm bolts [3] securely.

Install the following:

- thermostat
- rocker arms
- engine

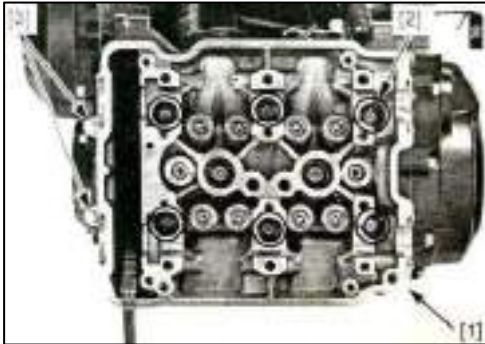

Tensioner adjusting screw

REMOVAL/INSTALLATION

NOTE:

The maintenance of the tensioner adjusting screw does not need to remove the engine from the frame. Remove the sealing bolt [1] and the sealing ring [2]. Use a special tool to turn the tensioner adjusting screw clockwise to ensure that it is fully tensioned.

Remove the tensioner mounting bolt [4] and sealing ring [5];

Remove the tensioner adjusting screw [1] and gasket [2].

The installation sequence is opposite to the removal sequence.

NOTE:

Replace the sealing ring and gasket with a new one.

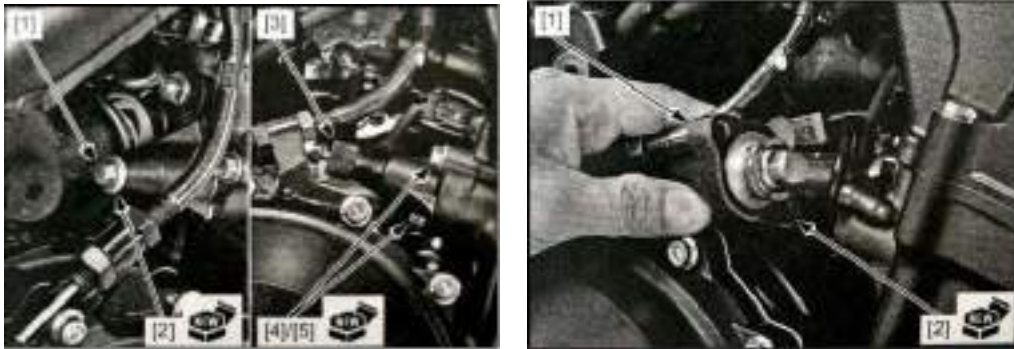

INSPECTION

Check the operability of the tensioner adjustment lever [1].

When pressing the tensioner adjusting rod, the adjusting rod should not be pressed into the adjuster.

When turning the adjusting rod clockwise with a Phillips card or screwdriver [2], the adjusting rod should be able to be pressed into the adjuster; when the tool is removed, the adjusting rod should immediately pop out of the adjuster.



CAM CHAIN/TIMING SPROCKET

Remove the following:

- cylinder head
- primary drive gear
- clutch outer

Remove the following:

Remove the bolt [1], the chain tensioning plate [2] and the bushing [3].



Remove the timing chain [1] and timing sprocket [2] from the crankshaft.



INSPECTION

Check the following parts for scratches, damage, abnormal wear and deformation.

Replace if necessary.

- Timing chain
- Chain tension plate
- Timing sprocket

INSTALLATION

Install the timing sprocket [1], and align the wide spline teeth of the sprocket with the wide keyway on the crankshaft.



Oil the whole surface of timing chain [1] and install with timing sprocket.



Apply a locking agent to the cam chain tensioner pivot bolt threads. Install the collar [1], cam chain tensioner [2] and bolt [3]. Tighten the cam chain tensioner pivot bolt to the specified torque.

TORQUE: 12N·m

Install the following:

- clutch outer
- primary drive gear
- cylinder head

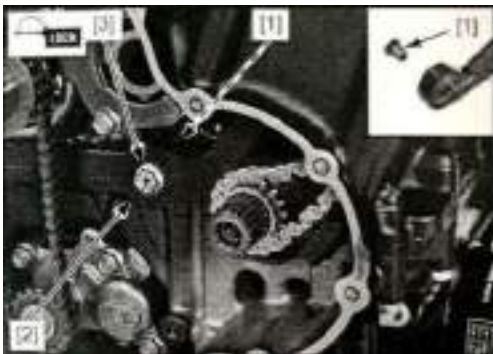

11.CLUTCH/GEARSHIFT CONTROL

MAINTENANCE INFORMATION	11-1
TROUBLESHOOTING	11-2
COMPONENT LOCATION	11-4
RIGHT CRANKCASE COVER	11-5
CLUTCH	11-7
PRIMARY DRIVE GEAR	11-16
GEARSHIFT SYSTEM	11-19

MAINTENANCE INFORMATION**GENERAL**

· This chapter introduces the maintenance of the clutch and shift mechanism, all operations do not need to remove the engine from the frame.

- Engine oil viscosity and oil level have an effect on clutch separation. When the clutch is not disconnected or the motorcycle is crawling with the clutch disconnected, check the engine oil level before repairing the clutch system.

TROUBLESHOOTING

Difficulty gripping the clutch handle

- The clutch cable is damaged, tangled or dirty
- Improper wiring of clutch cable
- Damaged clutch thrust mechanism
- Clutch push rod bearing failure
- Improper installation of the clutch lever

Clutch slips when accelerating

- Clutch push rod stuck
- Active friction plate wears out
- The clutch spring is not flexible enough
- The clutch handle has no free travel
- Molybdenum disulfide or graphite additives are added to the oil

When the clutch is not detached or the clutch is detached, the motorcycle is still moving slowly

The free stroke of the clutch handle is too large

Clutch friction disc warping

The oil level is too high, the oil viscosity is used improperly, or the oil additives are used

The lock nut of the clutch center sleeve is loose

Damaged clutch thrust mechanism

Improper installation of the clutch lever

Wear of clutch cover slot and clutch gear slot

Improper clutch operation

Hard to shift

- Improper adjustment of the clutch cable
- Improper clutch operation
- Improper use of oil viscosity
- Damaged or bent fork
- The fork shaft is bent
- The fork claw is bent
- Five-star plate bolts are loose
- The five-star dial plate is damaged
- Damaged gear shift drum guide groove
- Five-star dial plate is worn or damaged

Transmission jumps out of gear

- Worn shift drum stopper arm
- Weak or broken shift drum stopper arm return spring
- Loose shift drum center bolt
- Damaged shift drum center
- Bent shift fork shaft
- Damaged or bent shift forks
- Worn gear engagement dogs or slots

Gearshift pedal will not return

- Weak or broken gearshift spindle return spring
- Damaged or bent gearshift spindle

CLUTCH/GEARSHIFT CONTROL

COMPONENT LOCATION

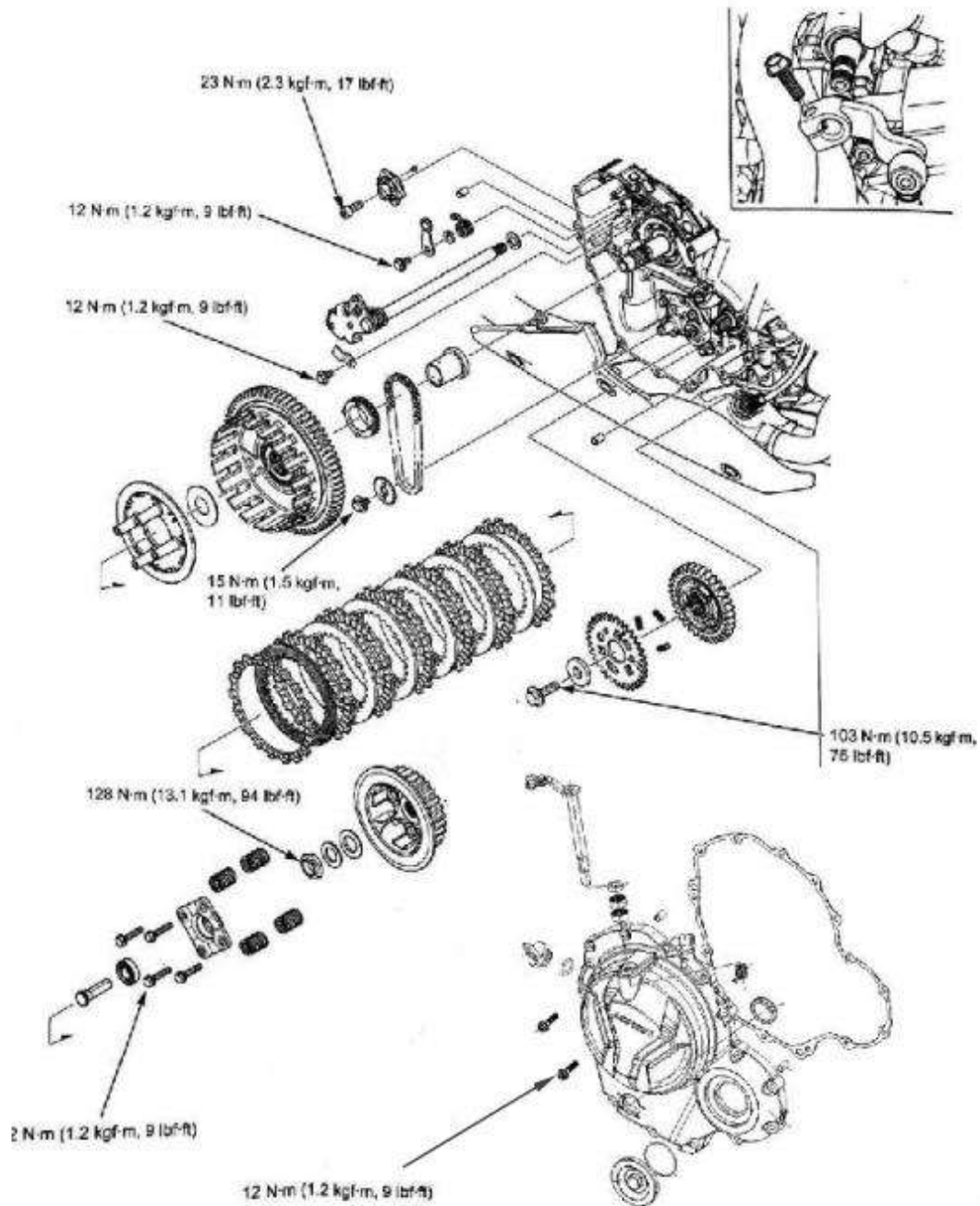

CLUTCH/GEARSHIFT CONTROL

**RIGHT CRANKCASE COVER
REMOVAL/INSTALLATION**

Remove the windshield under the motorcycle. Drain the engine oil. Remove the bolt [1] and the clutch brace positioning plate [2], and remove the clutch cable [4] from the clutch operating arm [3].



Remove the wire clamp [2] from the windshield support plate [1] under the motorcycle. Remove the bolts [3] and the support plate [4].

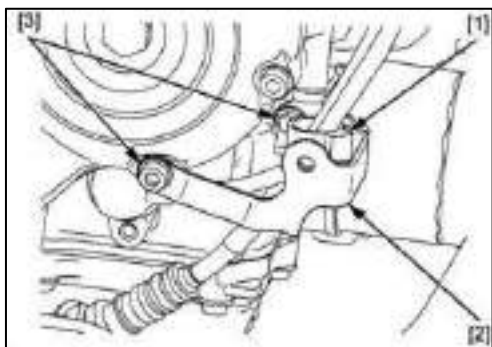

Loosen the right crankcase cover bolts [1] alternately in 2-3 times.

Remove the following parts:

- bolts
- right crankcase cover [2]



CLUTCH/GEARSHIFT CONTROL

Remove the positioning pin [1] and the gasket [2]. Clean the gasket material on the joint surface of the crankcase and the cover. Be careful not to damage the joint surface.

The installation sequence is opposite to the removal sequence.

TORQUE:

Right crankcase cover bolt: 12N.m

NOTICE:

Coat the end face sealant on the connecting part of the crankcase, as shown in the figure.

Replace the right crankcase cover gasket with a new one. Align the hole on the clutch brace positioning plate with the boss on the right crankcase cover. Adjust the free stroke of the clutch handle. Add the recommended engine oil to the crankcase and check for presence Engine oil has leaked.

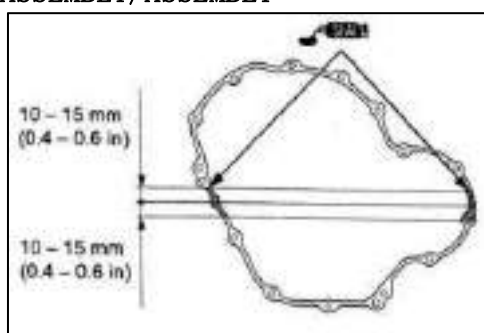
**DISASSEMBLY/ASSEMBLY**

Turn the clutch control arm [1], remove the small clutch push rod [2]. Remove the clutch control arm and return spring from the right crankcase cover [3].



CLUTCH/GEARSHIFT CONTROL

Remove the oil seal from the right crankcase cover [1]. The assembly sequence is the reverse of the disassembly sequence

Notice:

Grease the new oil seal. Install the oil seal to the specified depth, as shown in the figure. Align the hook on the return spring with the notch of the right crankcase, and align the return spring with the groove of the clutch operating arm. In the clutch operating arm and push rod Apply engine oil to the sliding surface of the machine.

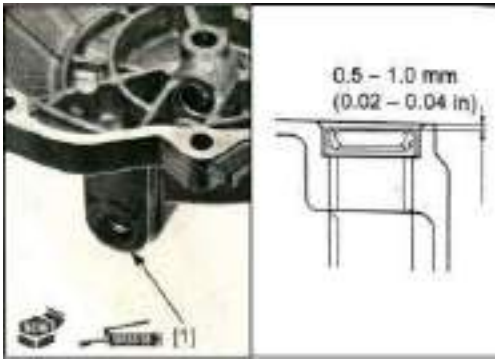

INSPECTION

Inspect the following parts for scratch, damage, abnormal wear and deformation.

- clutch lifter arm bushing
- clutch lifter arm
- return spring
- Small push rod

CLUTCH

REMOVAL

Remove the right crankcase cover, if necessary remove the clutch bushing

Remove the oil pump driven wheel sealing bolt



CLUTCH/GEARSHIFT CONTROL

Remove the clutch push rod [1]. Loosen the clutch lifting plate bolts [2] alternately in 2-3 times, remove the bolts, push plate [3] and clutch spring [4], and remove the lifting plate from the push plate Bearing[5].



Disassemble the locking crimp of the lock nut in the center of the clutch.

Note: Do not damage the spindle thread.



Use a tool to fix the clutch pressure plate, and at the same time loosen the lock nut [1].



Remove the lock nut. Remove the lock washer [1] and washer [2]. Remove the clutch center sleeve assembly [1].

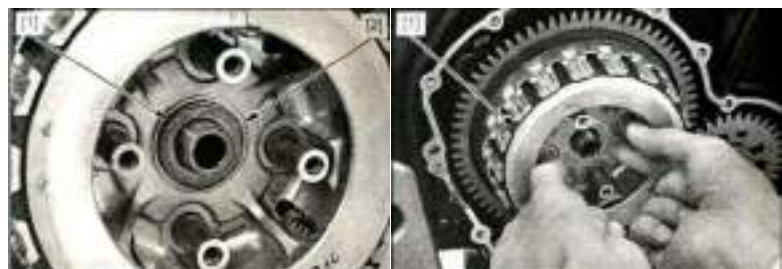

CLUTCH/GEARSHIFT CONTROL

Remove the following:

- clutch center[1]
- active friction disc of clutch[2]
- clutch disengaging friction disc[3]
- linking piece[4]

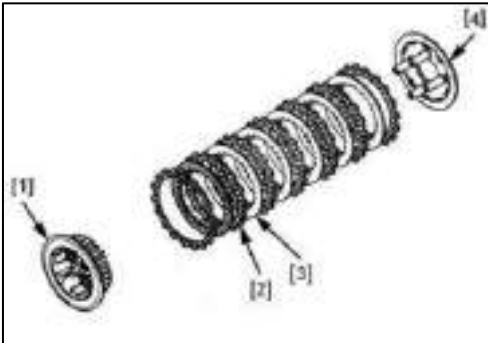

Remove thrust washer[1].



Insert a screwdriver into the primary driving gear groove [1] and move the gear so that the gear teeth are aligned with the primary driven gear, and install a 6×14mm bolt [2] at the primary driving gear positioning hole.



Remove the clutch cover[1].



Remove the following parts:

- Oil pump driven sprocket fastening bolt [1]
- Oil pump driven sprocket[2]
- Oil pump chain[3]
- Oil pump drive sprocket[4]



Remove the clutch bush[1].



INSPECTION

Check the following parts for scratches, damage, abnormal wear and deformation. If so, replace them.

CLUTCH/GEARSHIFT CONTROL

- big clutch putter
- clutch lift plate bearing
- clutch lift plate
- spring
- center set
- flat washer
- saucer reed
- master slave slide
- clutch housing/primary driven tooth/needle roller bearing
- clutch bush
- oil pump master slave sprocket
- oil pump chain
- main shaft

Measure each part according to the specifications of the clutch and shift mechanism. If any part exceeds the maintenance limit value, please replace it.

NOTE:

- Clutch springs are replaced in groups.
- The main and slave friction plates are replaced in groups.

INSTALLATION

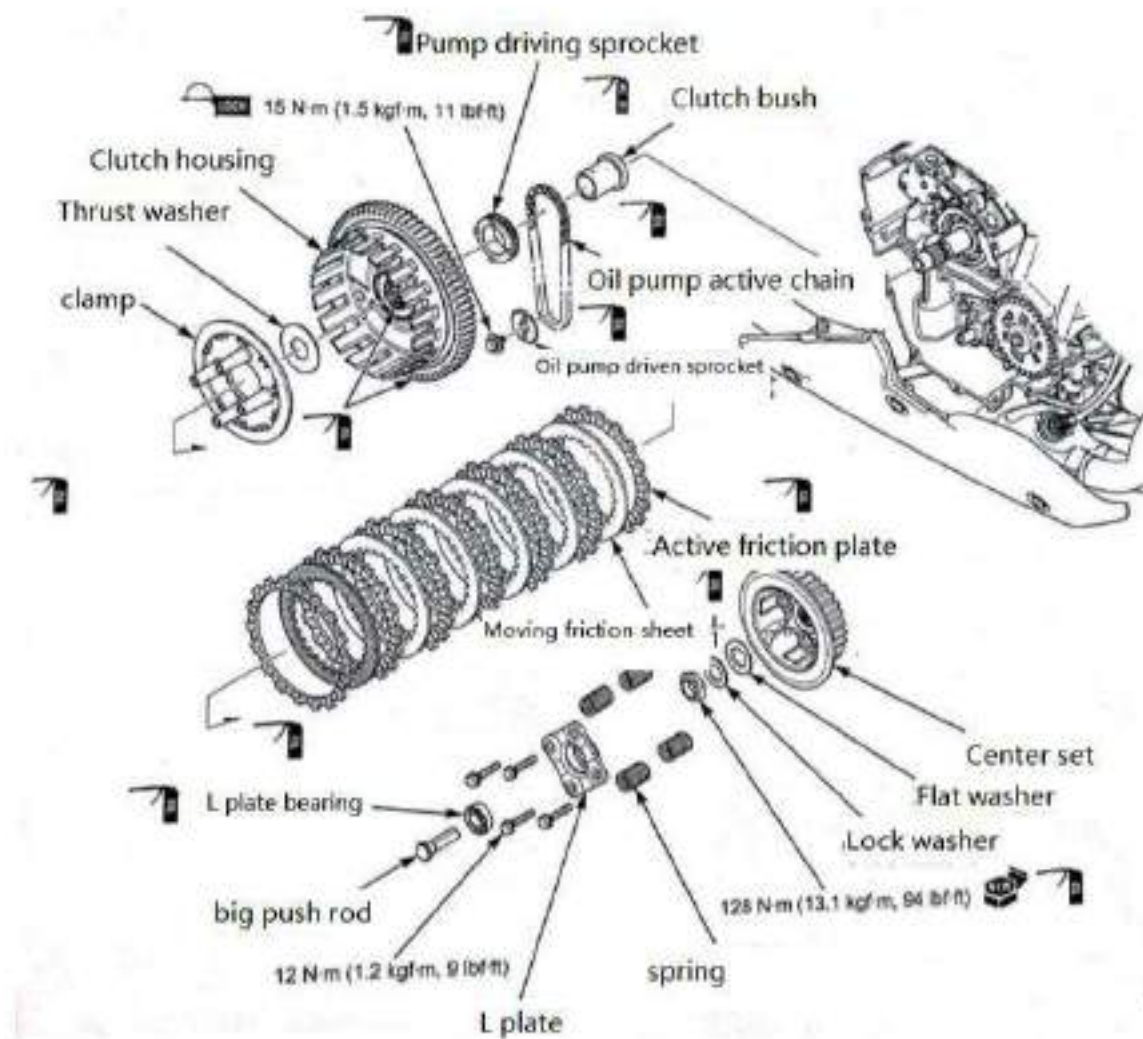

Apply molybdenum solution to the outer surface of the outer sleeve of the clutch [1], and install it to the main shaft.



CLUTCH/GEARSHIFT CONTROL

Apply clean engine oil to the gear teeth of the oil pump master and slave wheels and the drive chain. Install the oil pump drive wheel [1] and drive chain [2], paying attention to the "MGZ" mark [3] on the drive wheel facing upwards. Install the oil pump Follower [4], pay attention to the "OUT" mark [5] facing up, and align with the horizontal plane. Apply sealant to the threaded surface of the oil pump driven wheel sealing bolt. Install the oil pump driven wheel sealing bolt [6].

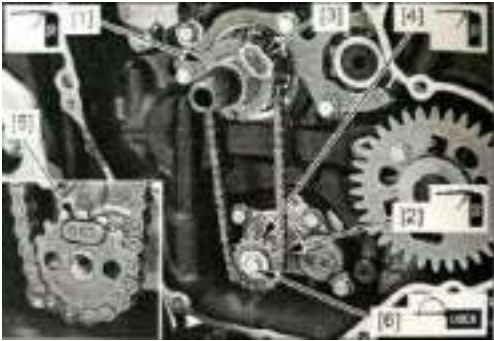

NOTE:

After installing the clutch, tighten the driven wheel bolts to the specified torque. Apply clean engine oil to the inner and outer holes of the needle roller bearing of the clutch cover, and the primary driving and driven tooth surfaces. Install the clutch cover [1], and place the The hole is aligned with the boss on the oil pump driving wheel. When installing the cover, turn the oil pump driven wheel.

NOTE:

Make sure that the primary driving gear and the driven gear are correctly meshed. Remove the 6×14mm bolt from the primary driving gear [3].

NOTE:

After installing the clutch housing, do not forget to remove the 6×14mm bolt.



CLUTCH/GEARSHIFT CONTROL

Install the thrust washer [1].



Apply clean oil to the clutch friction disc. Starting from the driving disc [1], install the driving disc and the driven disc [2] in turn. Install the clutch driven disc and pressure plate [3] to the clutch center sleeve [4], and align the pressure plate with the upper "O" mark of the center sleeve.

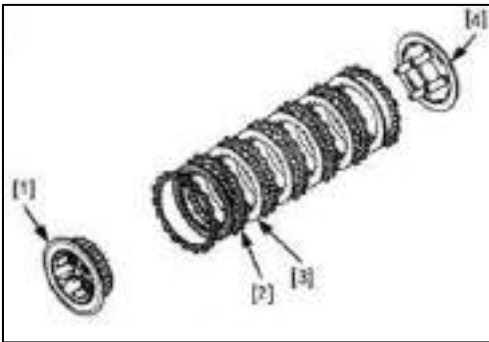

Install the clutch center sleeve assembly [1] on the clutch cover, and align the drive disc teeth with the tooth grooves on the cover one by one, and align the splines on the center sleeve with the ones on the main shaft.



Install the washer [1]. Install the anti-loosening washer [2], paying attention to its "OUTSIDE" mark facing outwards.



CLUTCH/GEARSHIFT CONTROL

Apply clean engine oil to the thread and seat surface of the clutch lock nut. Install the lock nut [1] on the spindle. Fix the pressure plate with a tool, and then tighten the lock nut to the specified torque.



Install the boss on the lock nut [1] into the groove on the spindle.

Be careful not to damage the threads of the spindle.



Apply clean engine oil to the rotating part of the lifting plate bearing. Install the lifting plate bearing [1] into the lifting plate [2]. Install the clutch spring [3], lifting plate and lifting plate bolts [4]. Divide 2-3 times Tighten the lifting plate bolts alternately and tighten them to the specified torque.

TORQUE: 12N·m



CLUTCH/GEARSHIFT CONTROL

Apply clean engine oil to the sliding surface of the small push rod. Install the small push rod [5]. Tighten the oil pump driven sprocket lock bolt [1] to the specified torque.

TORQUE: 12N·m

Install the right crankcase cover.



Primary driving gear

REMOVAL

Remove the right crankcase cover. Insert a screwdriver into the primary drive gear slot [1] and move the gear to align the teeth with the primary driven teeth, and install a 6×14mm bolt at the positioning hole of the primary drive tooth [2].



Fix the primary driving gear [1] with a tool, and remove the primary driving gear bolt [2] and washer [3].

TOOL:

[4] Gear stopper, 2.5

Remove the gear stopper and the primary driving gear.



CLUTCH/GEARSHIFT CONTROL

Remove the 6×14mm bolt [1] and the primary driving gear secondary tooth [2]. Remove the spring [3] from the secondary tooth slot.



INSPECTION

Inspect the following parts for scratch, damage, abnormal wear and deformation.

Replace if necessary.

- primary drive gear
- primary drive sub-gear
- springs

INSTALLATION

Apply molybdenum solution to the sliding surface of the primary driving tooth and the secondary tooth.

Install the spring [1] into the groove of the primary driving tooth [2]. Install the secondary tooth [3] on the primary driving tooth so that the label is on the spring end Part, and the index line of the "B" mark is aligned with the wide tooth, as shown in the figure.

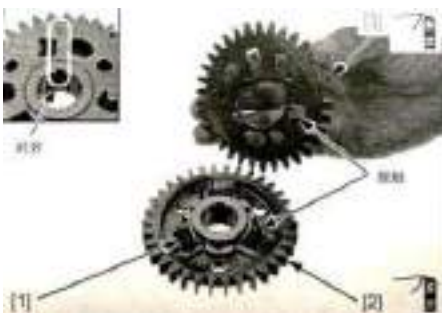

Loosely install a 6 x 14mm [1] bolt to prevent gear release.



Gearshift system

REMOVAL

Remove the following:

-clutch

-Shift arm

Clean the dirt on the shift shaft spline. Remove the bolt [1] and the limit plate [2].



The shift shaft assembly [1] and thrust washer [2] are pulled out of the crankcase.



Remove the hexagonal socket head bolt [1] of the five-star dial plate.



CLUTCH/GEARSHIFT CONTROL

Secure the stop plate [1] with a screwdriver and remove the five-star paddles [2] as shown.

Remove the following:

- dowel pin [3]
- Stop plate positioning bolt [4]
- Locking plate
- washer [5]
- return spring [6]



Remove bolts [1], shift arm oil seal pressure plate [2], oil seal [3] and needle roller bearings [4].

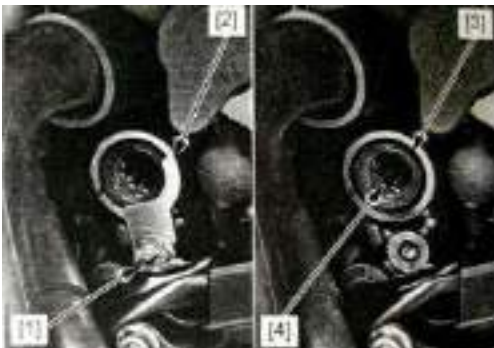

INSPECTION

Inspect the following parts for damage, abnormal wear and deformation.

Replace if necessary.

- shift drum center
- shift drum stopper arm
- shift drum stopper arm return spring
- gearshift spindle needle bearing

GEARSHIFT ARM

Check whether the shift arm torsion spring [1] and the shift plate torsion spring [2] are fatigued or worn, if necessary, replace it. Check whether the shift shaft [1] is worn or bent. Check whether the shift plate [2] Worn, damaged or deformed. If you need to replace, please replace the shift shaft in groups.



INSTALLATION

Apply clean engine oil to the shift arm needle bearing [1], and install it on the crankcase. Apply butter to the edge of the new oil seal [2], and install it into the crankcase to ensure that its surface is in line with the crankshaft. The roots of the box chamfers are flush. Apply tightening agent to the threads of the shift arm oil seal pressure plate bolts. Install the shift arm oil seal pressure plate [3] in the direction as shown in the figure, and tighten the bolts [4] to the specified torque.

TORQUE: 12N.m



Apply tightening agent to stop plate bolt threads. Install the return spring [1], gasket [2] and stop plate [3] and hook the return spring into the groove of the stop plate. Install and tighten the stop plate bolts [4] to specified torque.

TORQUE: 12N.m

Apply the fixator to the thread of the five - star plate positioning bolt.



CLUTCH/GEARSHIFT CONTROL

Install the positioning pin [1] into the pin hole on the speed change drum. Use a screwdriver to fix the stop plate [2] as shown in the figure. Install the five-star plate [3], and install the five-star slot on it. Set the plate positioning bolt [1] and tighten it to the specified torque.

TORQUE: 23N.m

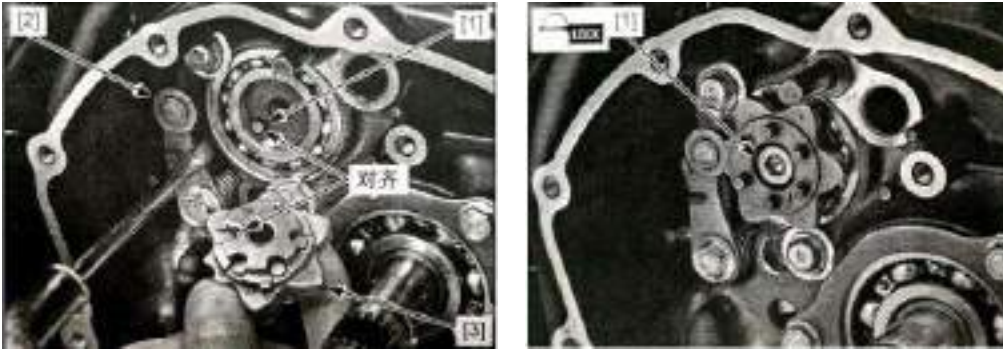

Apply clean engine oil to the outer surface of the shift shaft. Install the thrust washer [1] and the shift arm assembly [2] into the crankcase, and align the end of the aftertaste spring and the return spring pin.



Apply fixative to the threads of the pressure plate bolts. Install the pressure plate [1], bolts [2] and tighten them to the specified torque.

TORQUE: 12N.m

Install the following:

- shift lever
- clutch



CLUTCH/GEARSHIFT CONTROL

GEARSHIFT PEDAL REMOVAL/ INSTALLATION

Remove the locking bolt [1] and the shift lever [2] from the shift shaft. Remove the positioning bolt [3] and the shift pedal [4]. Remove the dust ring [5]. Check the dust ring and lever. Whether the ball head dust cover is deteriorated or worn, please replace it if necessary. The installation sequence is opposite to the removal sequence.

Torque:

Shift pedal positioning bolt: 27N·m

Notice:

Apply fixative to the edge of the dust-proof ring. When installing the dust-proof ring, pay attention to the edge of the dust ring. Apply the fixative to the pivot bolt area where the shift pedal slides. Apply the fixative to the ball end of the shift pedal lever. The slit on the gear arm is aligned with the machined hole on the shaft.



When adjusting the height of the shift pedal, operate by loosening the lock nut [1], and pay attention to the following points:

Notice:

Left-hand thread when tightening the lock nut at the end of the shift arm. Adjust the length of the tie rod until the distance between the two ball joint ends is the standard length, as shown in the figure. After the adjustment, tighten the lock nut of the shift pedal adjustment.

Notice:

Tighten the lock nut and make the ball joint parallel to the shift arm and shift pedal. Make sure that the thread length of the lock nut is less than the specified value.

-Shift arm end: 8.5mm

-Shift pedal end: 8.0mm

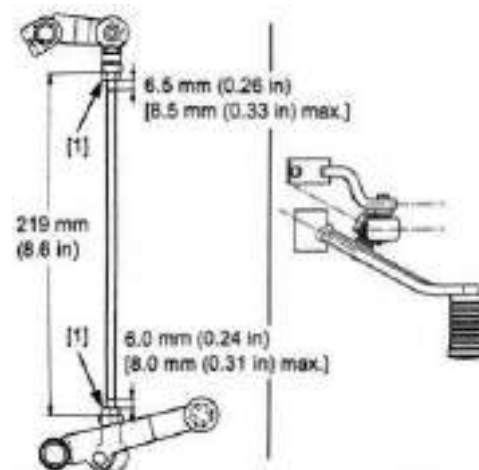

12.MAGNETO/STARTING CLUTCH

SERVICE INFORMATION-----12-1

MAGNETO SPINDLE -----12-4

AND TRIGGER

TROUBLESHOOTING -----12-1

MAGNETO ROTOR ----- 12-4

COMPONENT LOCATION----- 12-1

STARTER CLUTCH ----- 12-7

LEFT CRANKER COVER ----- 12-2

SERVICE INFORMATION

GENERAL

- This section covers service of the alternator stator and flywheel. All service can be done with the engine installed in the frame.
- Check the charging coil of alternator.
- Review of triggers.
- Maintenance of starting motor.

TROUBLESHOOTING

Starter motor turns, but engine does not turn

- Faulty starter clutch
- Damaged starter reduction gear/shaft
- Damaged or faulty starter motor pinion gear
- Damaged starter driven gear

COMPONENT LOCATION

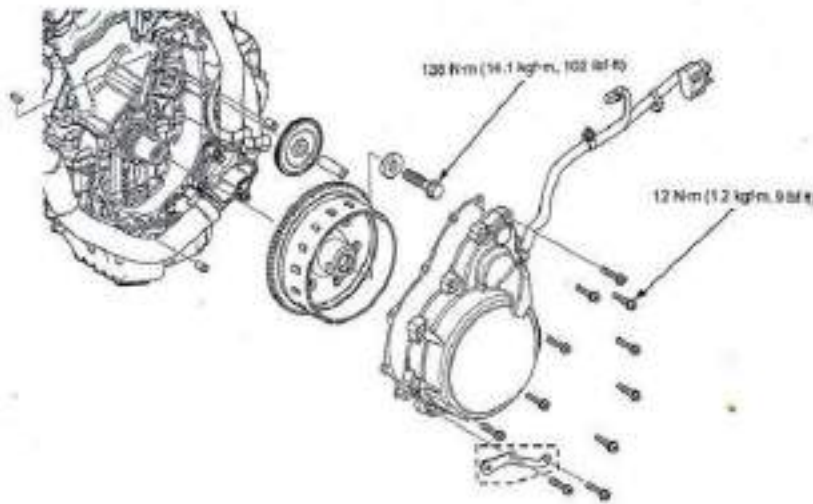

MAGNETO/STARTING CLUTCH

LEFT CRANKCASE COVER

REMOVAL/INSTALLATION

NOTICE:

When removing the left crankcase cover, place a clean oil pan at the bottom of the engine to prevent the oil from flowing out. After installation, fill the recommended amount of oil to the specified amount. Place the motorcycle on a level ground and keep it upright.

Disassemble the following parts:

- Undercarriage cover
- Drive sprocket cover
- Voltage regulating rectifier

Remove the trigger wire [2] from the wire clamp [1]. Disconnect the red connector of the trigger [3].

Remove the magneto stator and trigger wire harness belt clip from the frame (brown [4], black [5]).

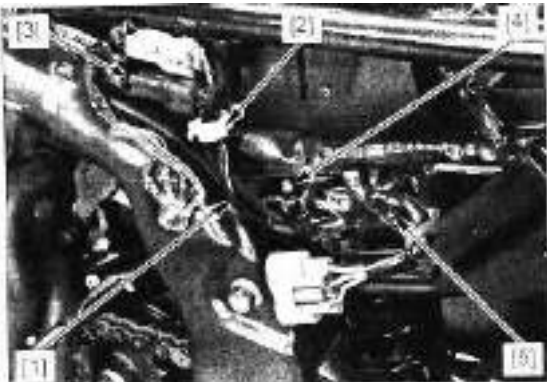

Remove the magneto spindle and trigger wiring harness from the frame from the workshop [1].



MAGNETO/STARTING CLUTCH

Loosen the left crankcase cover bolt in a few steps diagonally [1].

Remove the following parts:

- bolt
- Cover mounting plate[2]
- Left crankcase cover [3]

NOTICE:

The left crankcase cover (spindle) bears the magnetic attraction of the rotor. Be careful when removing and installing.

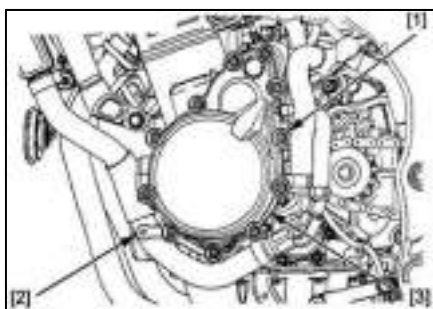

Remove the positioning pin [1] and the paper gasket [2]. Remove all the gasket material on the joint surface of the left crankcase and the cover

The installation sequence is opposite to the removal sequence.

Torque:

Left crankcase cover bolt: 12 N.m (1.2 kgf.m, 9 lbf.ft)

NOTICE:

Apply end sealant to the joint area of the crankcase, as shown in the figure. Replace with a new left crankcase cover paper gasket. Check the oil level. Make sure that there is no oil leakage.

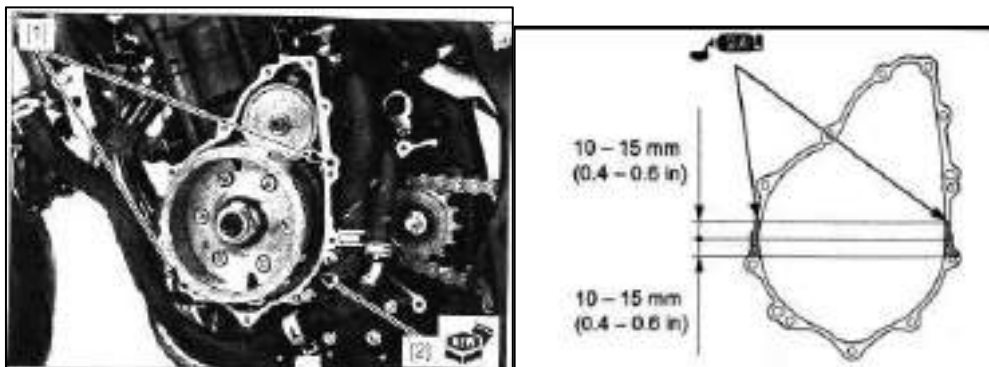

Magneto spindle and trigger

REMOVAL/INSTALLATION

Remove the left crankcase cover. Remove and install the spindle/trigger as per the diagram below. Apply thread glue to the threads of the spindle and trigger bolts. Apply the end face sealant to the sealing surface of the magneto/trigger wiring sleeve ring. The sequence of installation is reversed from that of disassembly

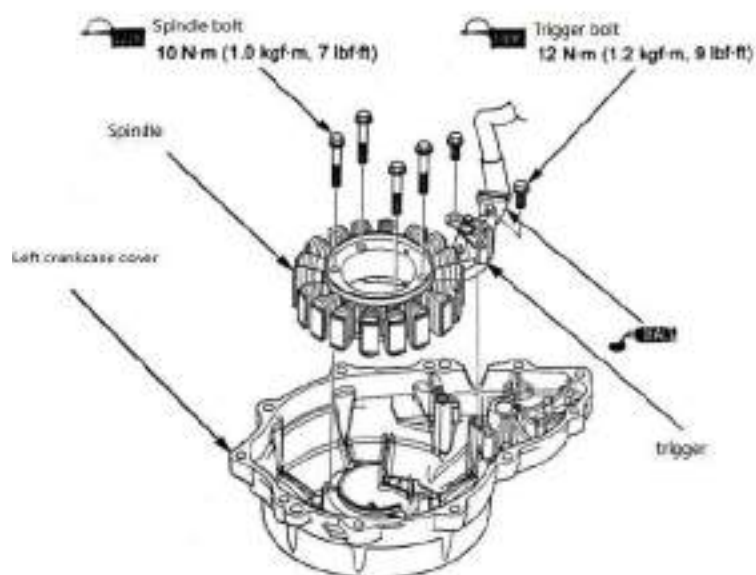

Magneto rotor

REMOVAL

Remove the left crankcase cover.

Remove the starter reduction gear shaft [1] and starter reduction gear [2].

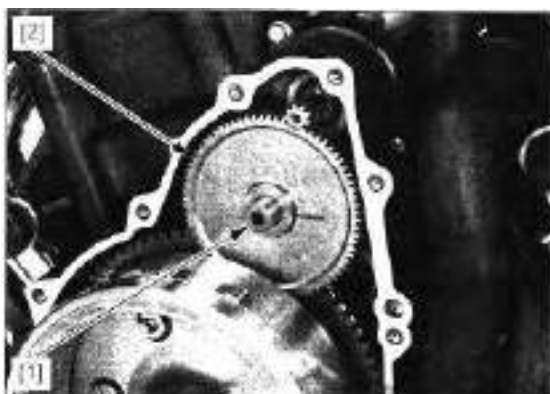

MAGNETO/STARTING CLUTCH

Hold the flywheel [1] using the special tool and loosen the flywheel bolt [2].

NOTICE:

Fixed block of magneto rotor retainer is installed to prevent rotor rotation. Remove rotor bolts and gaskets [5].

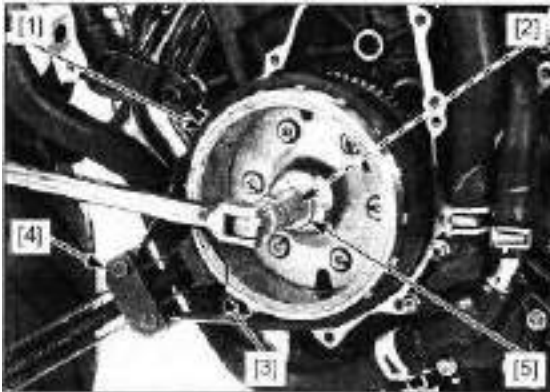

Remove the semicircle key [1]. Be careful not to damage the semicircle keyway and crankshaft.



MAGNETO/STARTING CLUTCH

INSPECTION

Inspect the following parts for scratch, damage, abnormal wear and deformation. Replace if necessary.

- starter reduction gear shaft
- starter reduction gear
- woodruff key
- needle bearing

INSTALLATION

Install the woodruff key [1]. Apply engine oil to the needle bearing [2] rotating area. Be careful not to damage the key groove and crankshaft.



Thoroughly clean the crankshaft cone and inner hole of the rotor oil. Install the rotor [1], NOTICE align the semicircular keys on the crankshaft with the keyway on the rotor.

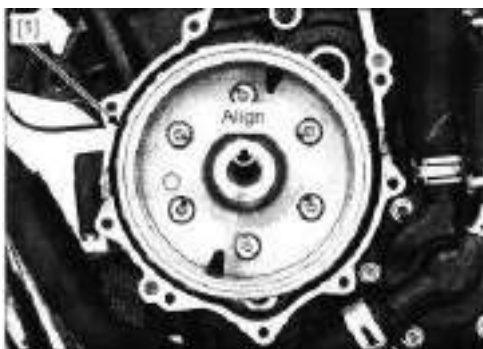

Apply clean engine oil to rotor bolt threads and mounting surfaces. Install gaskets [1] and rotor bolts [2]. Secure the magneto rotor [1] with magneto retainer and tighten the bolts to the specified Torque.

NOTICE:

Install the magneto rotor retainer to prevent the rotor from rotating.

Torque: 138N·m

MAGNETO/STARTING CLUTCH

Apply molybdenum disulfide solution to outer surface of twin gear shaft. Install double gear [1] and shaft [2]. Install left crankcase cover.

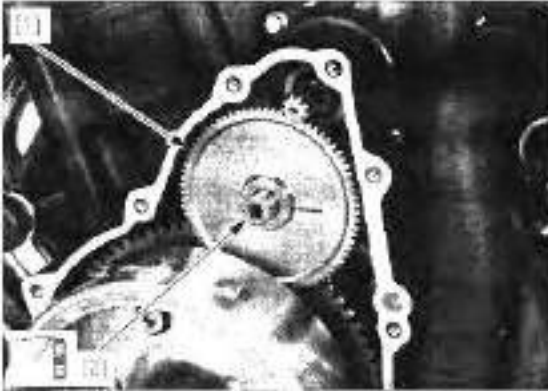

Starting clutch

Check one-way clutch operation

Remove the rotor. Check the operation of the starting clutch by rotating the disc teeth [1]. Check whether the disk teeth turn clockwise smoothly or not.

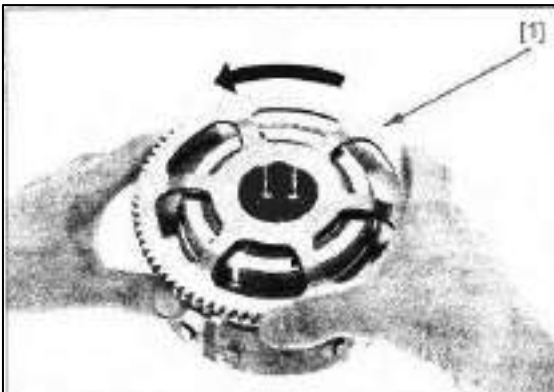

REMOVAL

Remove rotor. Rotate disk tooth clockwise and remove bottom disk tooth [1].

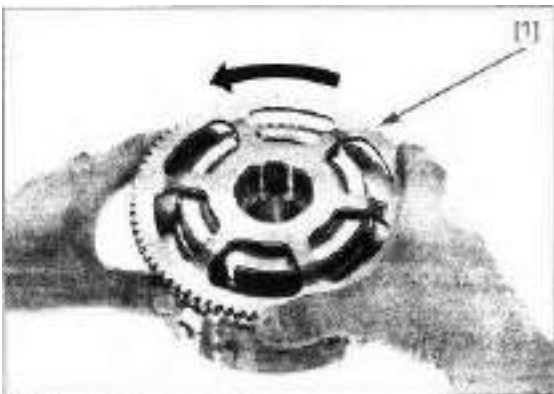

MAGNETO/STARTING CLUTCH

The magneto rotor was fixed with a magneto fixator [1] and the starting clutch fastening bolts [2] were removed.

NOTICE:

Fixed block [4] is installed in magneto rotor fixator [3] to prevent rotor rotation.



Remove the starter clutch assembly. Remove starter clutch [2] from starter clutch housing [1].



INSPECTION

Inspect the following components for scratches, damage, abnormal wear or deformation.

Replace if necessary.

- pan tooth
- Clutch housing
- Start clutch

Ensure that all components conform to magneto and starting clutch specifications. If exceeding service limits. Then replace the parts,

Installation

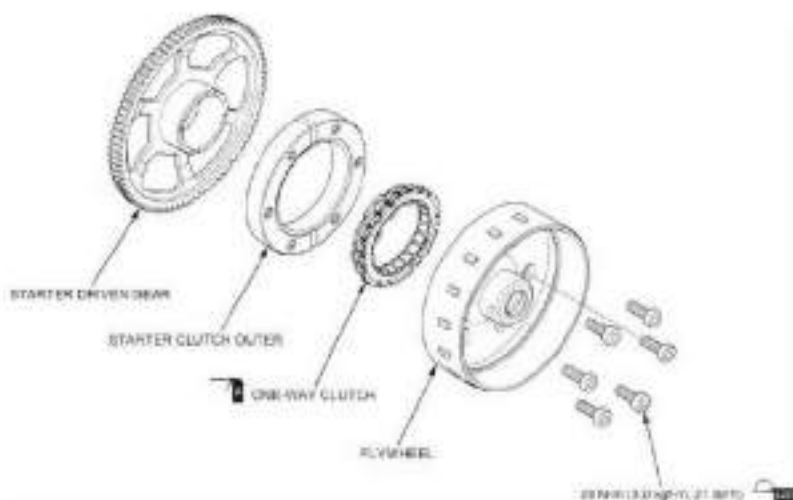

MAGNETO/STARTING CLUTCH

Apply clean engine oil to the contact surface of the starting clutch. Install the starting clutch [1] on the starting clutch cover [2]. Install the starting clutch combination to the rotor [3].

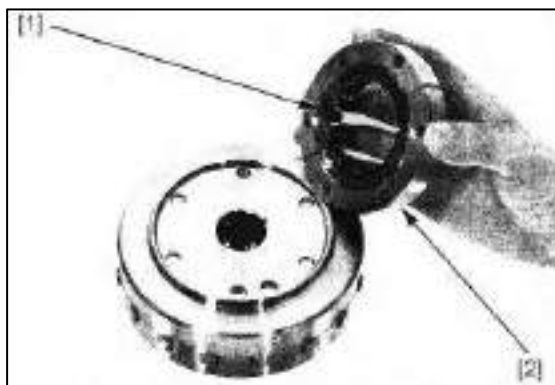

Fix the rotor in place with a rotor [1] retainer.

NOTICE:

Install magneto rotor holder [2] fixing block [3] to prevent rotor rotation. Apply tightening agent to the clutch fastening bolt threads. Install and tighten the fastening bolts [4] to the specified torque.

Torque: 29N·m

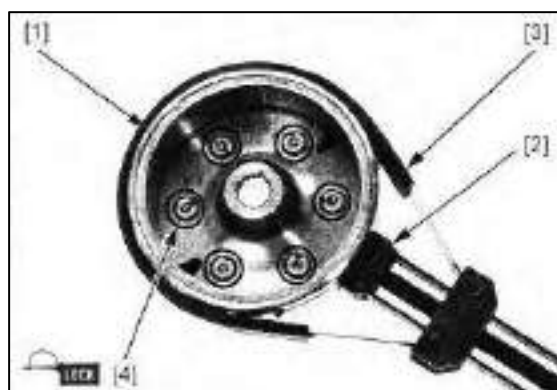

Turn the disc teeth clockwise [1] and install the disc teeth into the starting clutch housing. Check the operation of starting clutch. Install the rotor.

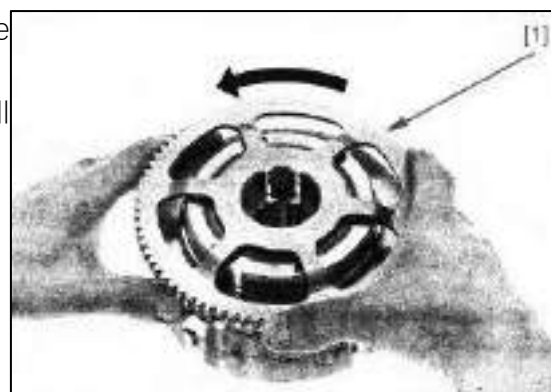

13. CRANKCASE/TRANSMISSION

SERVICE INFORMATION	13-1
TROUBLESHOOTING	13-2
COMPONENT LOCATION	13-3
TRANSMISSION	13-4
CRANKCASE	13-8

SERVICE INFORMATION

GENERAL

The crankcase must be separated to service the following:

1. transmission
2. crankshaft
3. balancer
4. piston/connecting rod/cylinder

The following components must be removed before separating the crankcase:

1. engine
2. Shift system
3. Magneto assembly
4. Cylinder head parts
5. Tensioner
6. Tensioning board and guide board
7. Oil strainer
8. Pressure relief valve
9. Fine oil filter
10. Pump
11. Pipe
12. Oil pressure sensor
13. Speed sensor
14. File display switch parts

Do not damage the joint surface of the box body during maintenance.

- Clean the oil duct before assembling the crankcase.
- Before closing the box, apply face sealant evenly on the surface of the box, and clean up the excess sealant.
- Choose suitable color tags for connecting rod big-head bearing and spindle bearing, and select bearing according to the requirements in the bearing selection table. Check the oil gap after installing the bearing, incorrect oil gap will cause major damage to the engine.

TROUBLESHOOTING

Difficult to shift gears

Improper clutch operation

·Improper oil viscosity

Deformation of fork

Deformation of fork shaft

Deformation of fork and pawl

Damaged to the guide groove of the gear shift drum

Deformation of shift arm

Gear skipping

·Gear wear

Wear and tear on the guide groove of the variable speed drum

Deformation of fork shaft

Damaged gear shift drum

Damaged positioning plate torsion spring

Worn or deformed shift fork

Damaged shift arm

Engine noise is too loud

Worn or damaged transmission gear

Wear or damage to the transmission bearing

TRANSMISSION

REMOVAL/DISASSEMBLY

Remove the lower crankcase body. Align the scale line of the balance driving gear with the joint surface of the box body.

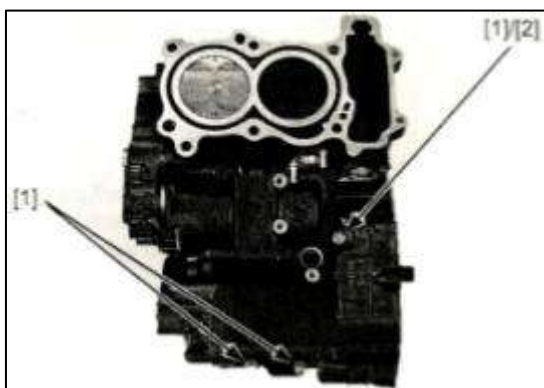

Turn the engine upside down. Loosen the M10 bolt [1], M8×75 bolt [2], M8×55 bolt [3] and M6 bolt [4] on the box in 2 or 3 times, and then remove all bolts and flats. Washer [5].

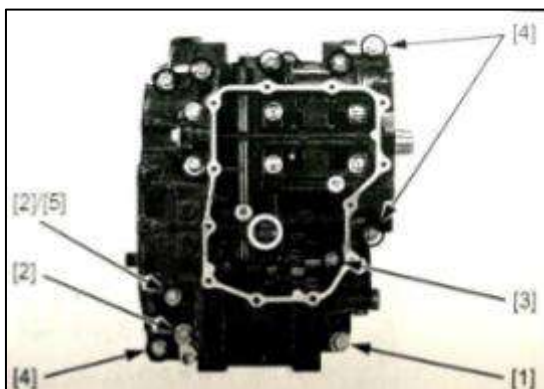

Loosen the box main shaft bolt [1] and remove the bolts in 2 or 3 times. Remove the lower crankcase [2] from the upper crankcase (NOTICE: You cannot use a screwdriver to pry the crankcase joint surface).

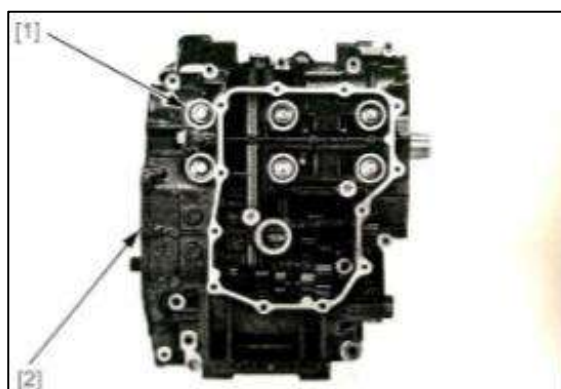

CRANKCASE/TRANSMISSION

Remove the positioning pin [1] and the oil passage plug [2].

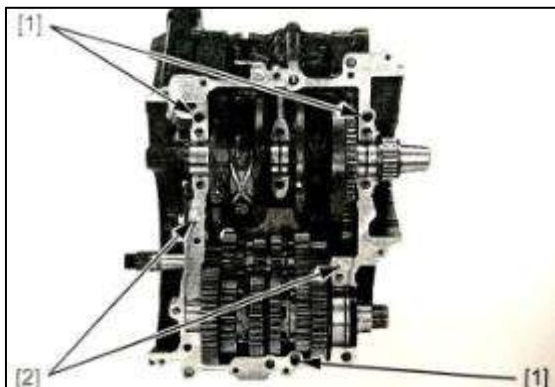
**ASSEMBLY**

Clean the joint surfaces of the upper and lower crankcases, NOTICE do not damage the joints. Check whether the oil passages of the case are blocked, and clean the oil passages if necessary. As shown in the figure on the right, apply end sealant evenly on the joint surfaces of the lower case.

NOTICE:

Do not apply excessive end face sealant.

Do not apply end face sealant to the position of the main neck bolt and the position of the oil passage hole.

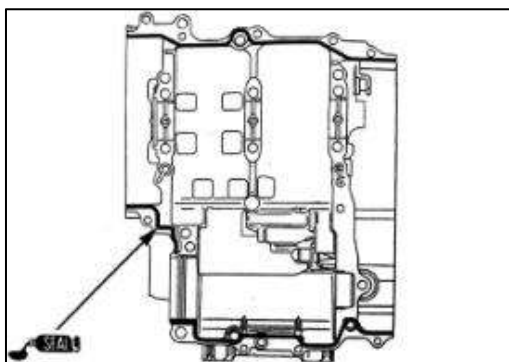

Check whether the oil passage plug is blocked, and replace the oil passage plug if necessary. Install the oil passage plug [1] on the upper crankcase body [2], and put the larger hole side into the upper crankcase body during installation.

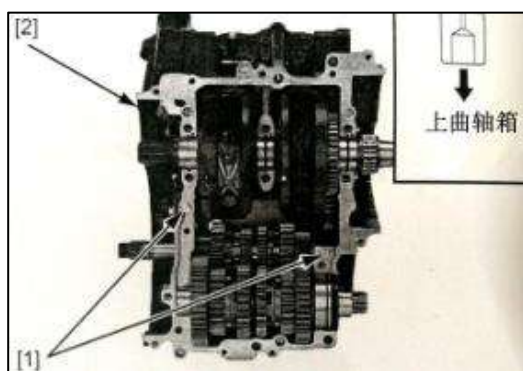

CRANKCASE/TRANSMISSION

Install the positioning pin [1] into the upper crankcase [2].

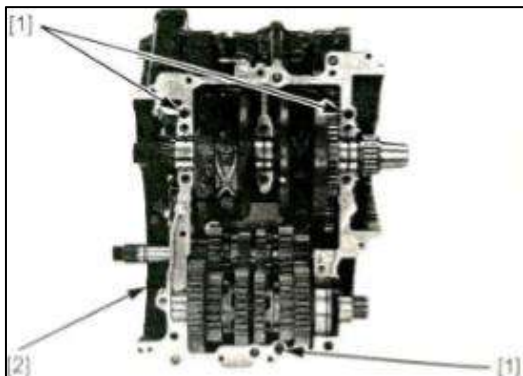

Apply engine oil to the upper and lower crankcase main journal bearings [1].

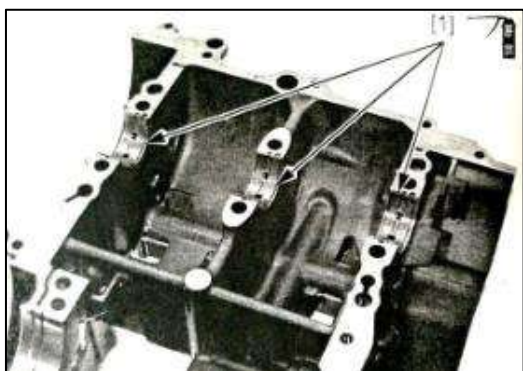

Install the lower crankcase [1] to the upper crankcase. Install the new main journal bolt [2].

NOTICE:

Use the cross method to tighten the main journal bolts. Do not use the used main journal bolts because the axial tension of the bolts is incorrect.

The main journal bolts should be pre-coated with oil before installation to increase their axial tensile stability. Do not wipe off the oil on the surface of the bolts during installation. Make sure that the upper and lower crankcases are installed firmly.

Tighten the main journal bolts to the specified Torque in 2-3 times in the order shown in the figure. Rotate the main journal bolts by 120° to further tighten the bolts.

Torque: 15N.m+120°

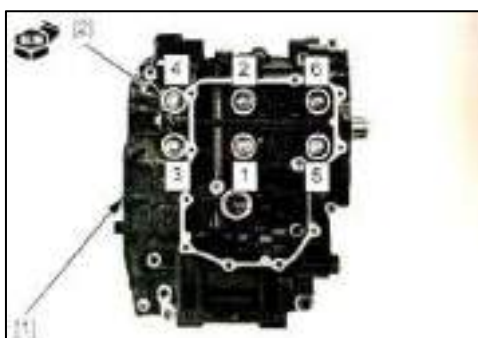

Replace with new flat washers and box closing bolts. Tighten the box closing bolts in 2~3 times to the specified Torque.

NOTICE:

The flat washer is installed at the position shown in the right figure [1].

Torque:

M10 bolt [2] : 39 N.m

M8 ×75 bolt [3] : 24 N.m

M8 ×55 bolt [4] : 24 N.m

M6 bolt [5] : 12 N.m

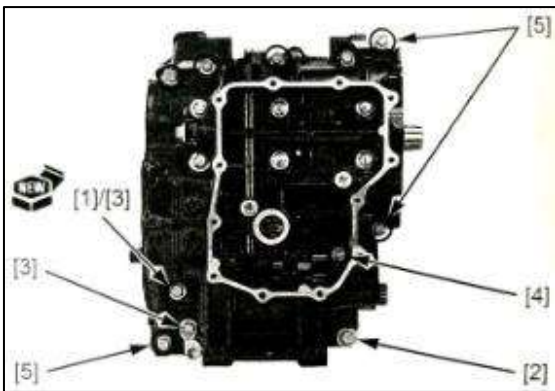

Turn the engine over until the bottom is facing down. Install a new flat washer and M6 box closing bolt.

NOTICE:

Install the flat washer at the position shown in the right figure [1]. Tighten the M6 bolt to the specified Torque.

Torque: 12 N.m

Install the disassembled parts in the reverse order of disassembly

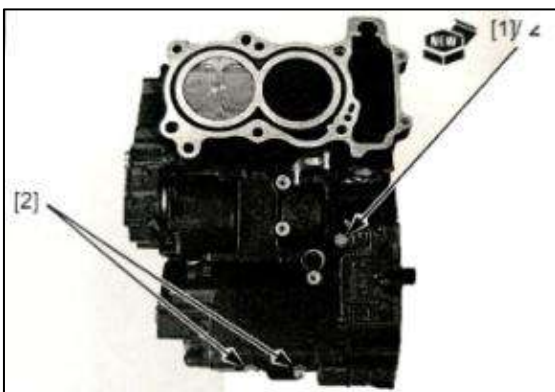

CRANKCASE

REMOVAL/DISASSEMBLY

Disassemble the upper and lower crankcases. Make the engraved line [1] on the balance gear flush with the box surface of the upper crankcase and face forward

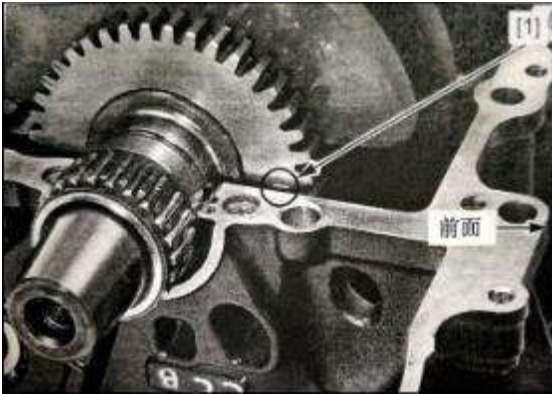

Remove the countershaft combination [1] and pin shaft [2].

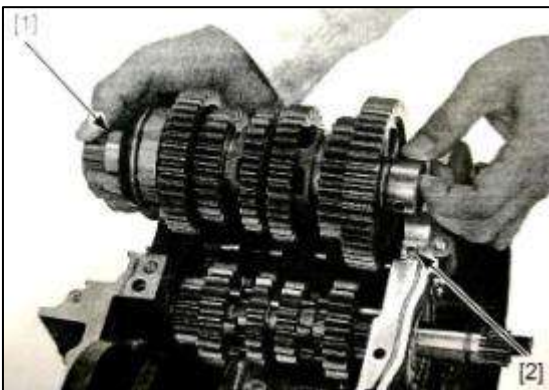

Remove the bearing stop bolt [1] of the gear shift drum.



CRANKCASE/TRANSMISSION

Disassemble the shift fork shaft [1] and shift fork [2]

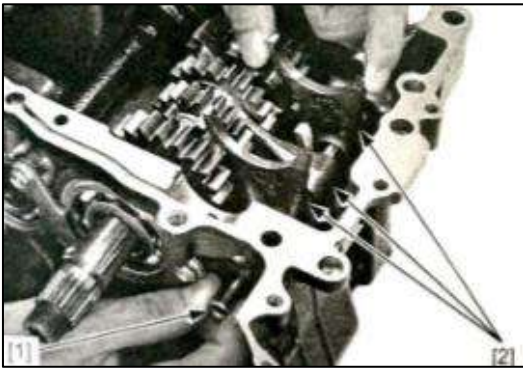

Disassemble the transmission drum [1] and the transmission drum bearing [2]

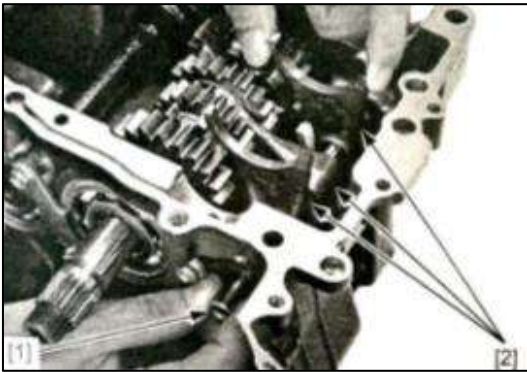

Remove the bolt [1] and the spindle bearing pressure plate [2].

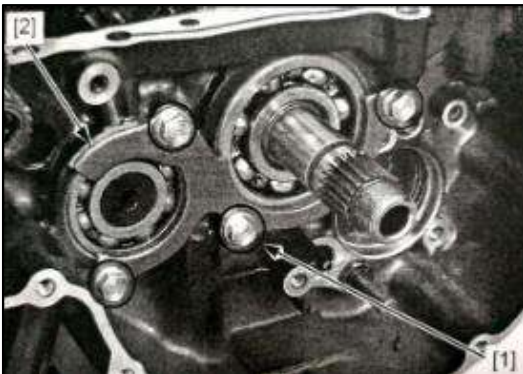

Slide the main shaft part on the upper crankcase and remove the main shaft right bearing.



Disassemble the spindle parts.



Disassemble the main shaft part and the counter shaft part.

NOTICE:

Place the disassembled gears, bushings, washers, and snap rings in a special container or in a straight line.

Do not extend the snap ring beyond its limit. When disassembling the snap ring, first expand the snap ring, and then use the gear behind the snap ring to push the snap ring out.



INSPECTION

Check the following parts for scratches, damage, abnormal wear and deformation. Replace parts if necessary.

- ▶ Transmission gear
- ▶ Drive shaft sleeve
- ▶ Transmission bearing
- ▶ Drum/Drum Bearing
- ▶ Shift fork
- ▶ Shift fork shaft

Measure the size of each part and calculate the fit clearance according to the standard. If the fit clearance exceeds the standard limit value, replace the part.

Replacement of outer ring of spindle left bearing

Disassemble the following parts:

- ▶ Balance shaft
- ▶ Piston

Remove the bolt [1] and the bearing baffle [2]. Use a special tool to remove the outer ring of the left spindle bearing [3]. Use the special tool to knock the outer ring of the new left bearing of the spindle into the lower crankcase from directly above. Completely in place.

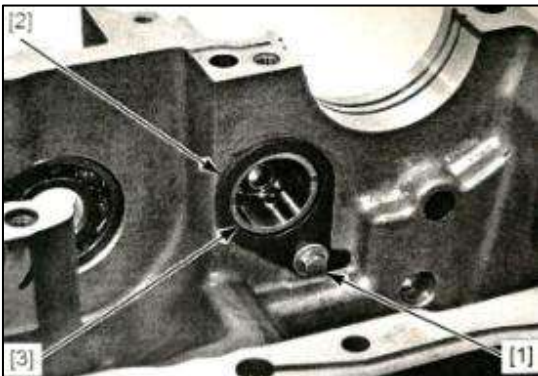

CRANKCASE/TRANSMISSION

Apply thread fastening glue to the threaded part of the bearing housing outer ring baffle bolt. Install the bearing housing outer ring baffle, bolt and tighten the bolt to the specified torque.

Torque: 12N.m

Install the removed parts in the order of removal.

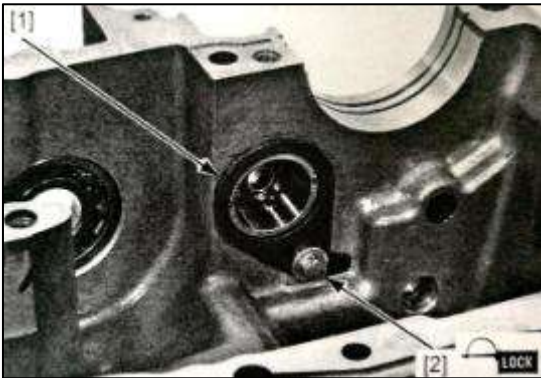

ASSEMBLY

Wash all parts with solvent and dry them thoroughly. Apply oil to the gear tooth surface, rotating surface and bearing. On the outer surface of the gear spline sleeve, the entire surface of the gear bushing, the needle bearing rotation area and the gear transmission groove area Apply engine oil. Install the main shaft part and the counter shaft part.

NOTICE:

Apply engine oil to each gear and check whether it rotates smoothly. Align the inner spline of the spline washer with the keyway. When installing the thrust washer, always follow the thrust surface of the gear axially. When installing the snap ring, align the opening gap with the spline groove [1]. Make sure that the snap ring is completely installed in the shaft groove after installation.

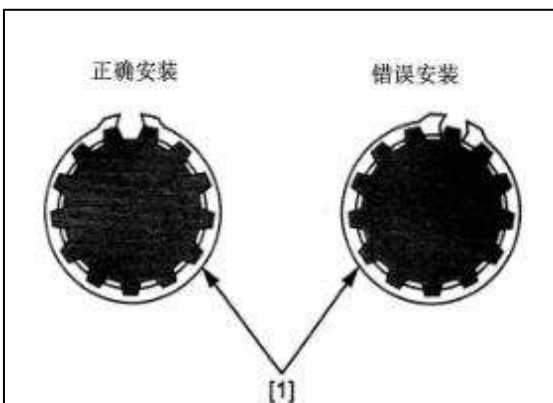

CRANKCASE/TRANSMISSION

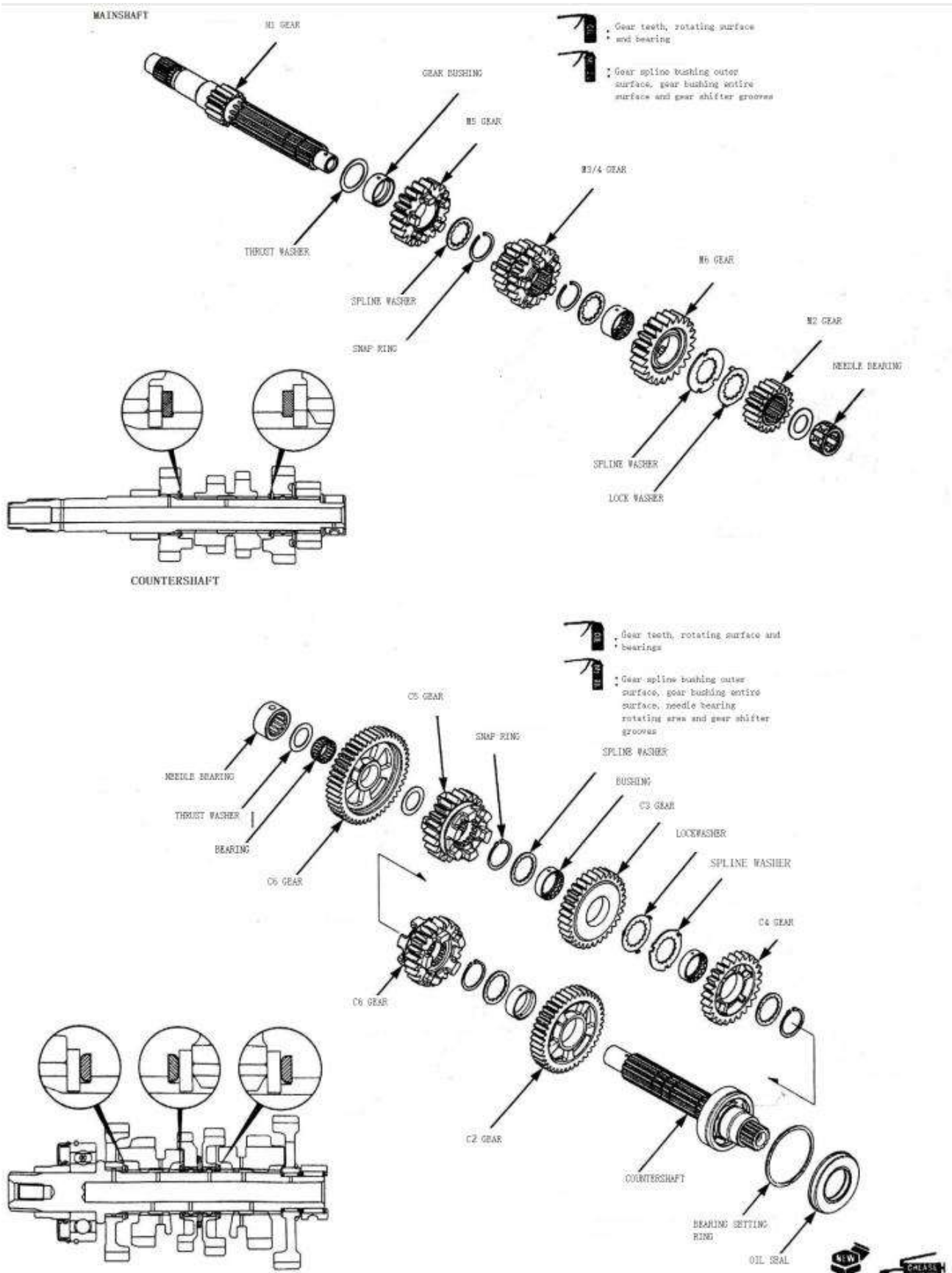

INSTALLATION

Rotate the crankshaft so that the scale mark [1] on the balance driving gear is aligned with the box surface and faces forward.

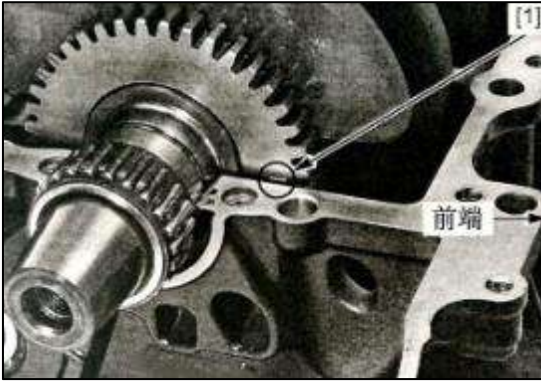

Install the main shaft component [1] into the upper crankcase.

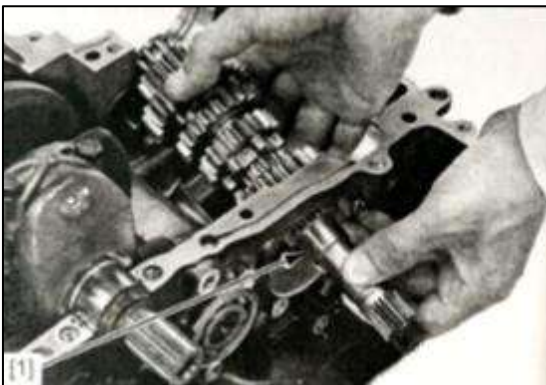

Apply engine oil to the right bearing of the spindle, and install the right bearing [1] of the spindle into the upper crankcase. When installing the right bearing of the spindle, the side with the mark will face outward.



CRANKCASE/TRANSMISSION

Install the spindle bearing pressure plate [1] and bolts [2], apply thread fastening glue to the threaded part of the bolts before installation. Tighten the bolts to the specified torque.

Torque: 12N.m



Apply oil to the outer surface of the transmission drum bearing and the transmission drum. Install the transmission drum bearing [1] on the transmission drum [2]. When installing, the marked side of the transmission drum bearing faces outwards. Place the transmission drum and the transmission drum bearing. The combination is installed on the upper crankcase.

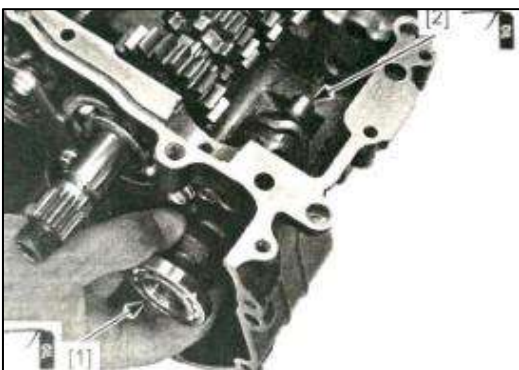

The shift fork has the following identification marks:

"L" [1]: Left fork

"C" [2]: Middle fork

"R" [3]: Right fork

Apply engine oil to the shift fork shift guide area and the position of the guide pin.



CRANKCASE/TRANSMISSION

Apply oil to the surface of the shift fork shaft. Install the shift fork [1] on the gear shift drum guide groove and shift groove (middle shift fork) with the identification mark facing the right side of the engine, and then insert the shift fork shaft [2].

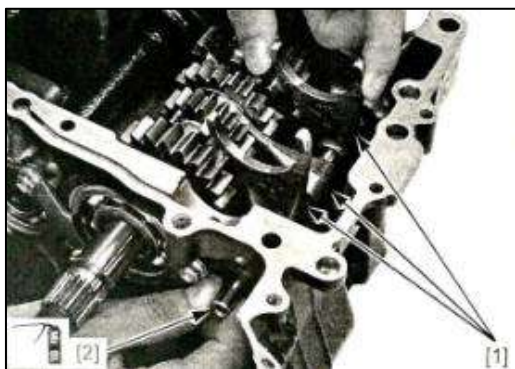

Apply thread sealant to the threaded part of the transmission drum bearing washer bolt. Install the transmission drum bearing washer and bolt in place, and tighten the bolt to the specified torque.

Torque: 12N.m

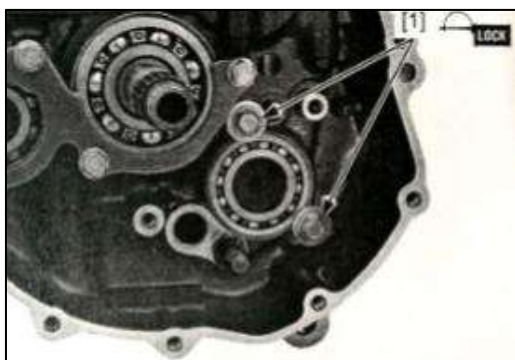

Install the cylindrical pin into the upper crankcase. Install the countershaft components on the upper crankcase. When installing, install the oil seal and the stop ring into the groove of the box, and the hole in the outer ring of the needle roller bearing is aligned with the cylindrical pin.

NOTICE:

Ensure that the marking line on the needle bearing cap is aligned with the box surface. Assemble the crankcase.

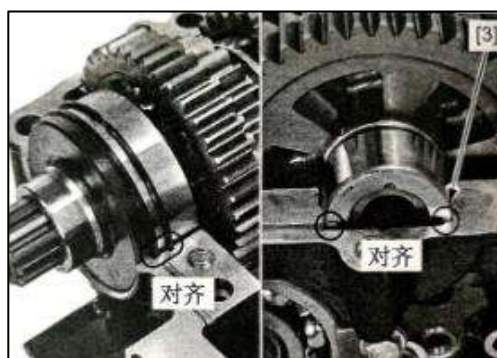
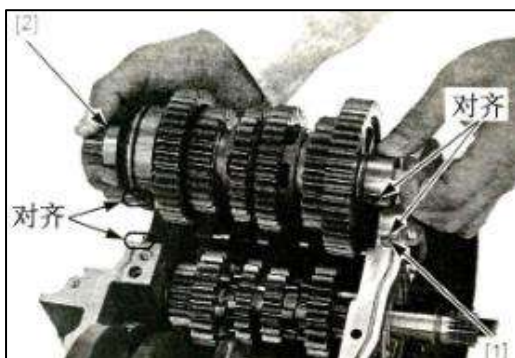

14. CRANKSHAFT/PISTON/CYLINDER/BALANCER

SERVICE INFORMATION -----	14-1	CRANKPIN BEARING-----	14-10
TROUBLESHOOTING -----	14-1	PISTON/CYLINDER-----	14-14
COMPONENT LOCATION -----	14-2	PISTON OIL JET -----	14-18
CRANKSHAFT -----	14-3	BALANCER -----	14-18
MAIN JOURNAL BEARING -----	14-7		

SERVICE INFORMATION

GENERAL

When servicing the crankshaft, balance shaft, cylinder block, piston/connecting rod and fuel injector, the crankcase must be separated. Refer to the crankcase section for the method of separating the crankcase. Mark and store the connecting rod big end, connecting rod cover and bearing shell, in order to ensure that the above components are in the correct position during reassembly. The crank pin and the main journal bearing bush are selected and matched by color. The bearing bush is selected according to the color matching table. After selecting the new bearing bush, re-use the plastic plug gauge to confirm the oil film clearance. Oil film clearance incorrect will cause severe engine wear.

TROUBLESHOOTING

Cylinder compression is too low, hard to starting or poor performance at low speed

- Leaking cylinder head gasket
- Worn, stuck or broken piston ring
- Worn or damaged cylinder and piston

Cylinder compression too high, overheating or knocking

- Excessive carbon built-up on piston head or combustion chamber

Excessive smoke

- Worn cylinder, piston or piston ring
- Improper installation of piston rings
- Scored or scratched piston or cylinder wall

Abnormal noise

- Worn piston pin or piston pin hole
- Small head wear of connecting rod
- cylinder block, piston or piston ring wear
- worn crankpin bearing bush

Engine vibration

- Excessive crankshaft runout

CRANKSHAFT/PISTON/CYLINDER/BALANCER

COMPONENT LOCATION

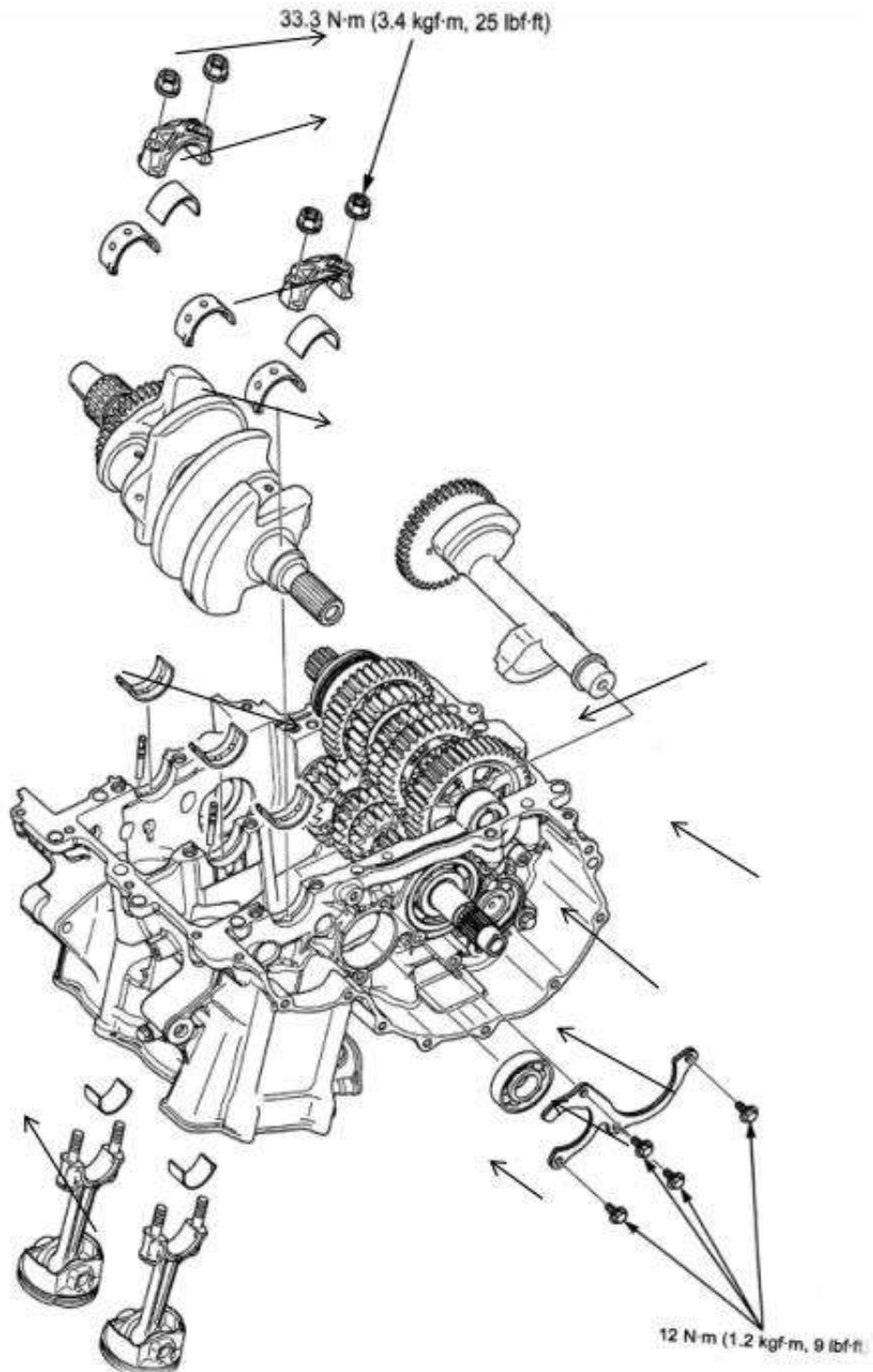

CRANKSHAFT/PISTON/CYLINDER/BALANCER

CRANKSHAFT

SIDE CLEARANCE INSPECTION

Separate the crankcase halves. Measure the connecting rod side clearance.

SERVICE LIMIT: 0.25mm .

If the clearance exceeds the maintenance limit, replace the connecting rod. Reconfirm the side clearance and replace the crankshaft if the limit is still exceeded.



Remove

NOTICE:

Do not change the position of the bearing bush. The bearing bush must be installed in the initial position, otherwise the correct oil film gap will be destroyed and the engine will be damaged. Separate the upper and lower crankcases. Mark before removing the connecting rod cover and bearing bush to ensure correct reassembly. Take off Lower connecting rod cover nut [1] and connecting rod cover [2].

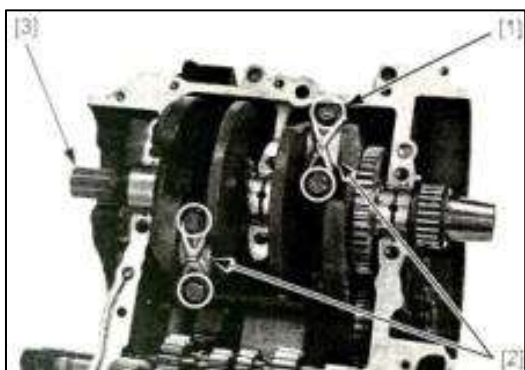

NOTICE:

Do not damage the crank pin, main journal and bearing bush. If the connecting rod cover is difficult to remove, tap the side of the connecting rod cover lightly. Remove the crankshaft [3].

NOTICE:

Before removing the crankshaft, push the piston to the top dead center to prevent damage to the crank pin. Remove the main journal bearing shell from the upper and lower crankcases [1].

CRANKSHAFT/PISTON/CYLINDER/BALANCER

Remove the crank pin bearing shell from the connecting rod big end and the connecting rod cover [2].

NOTICE:

Do not change the position of the bearing bush. The bearing bush must be installed in the initial position, otherwise it will destroy the correct oil film clearance and cause damage to the engine.

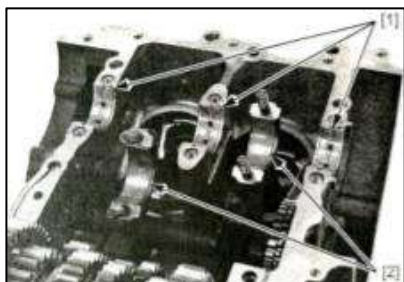

INSPECTION

Support the journals at both ends of the crankshaft. Place a dial gauge above the middle main journal, avoiding the oil groove and oil hole when placing it. Rotate the crankshaft twice (720°) and read the runout value.

Maintenance limit: 0.05 mm

Check the balance shaft driving gear [1] for abnormal wear or damage.

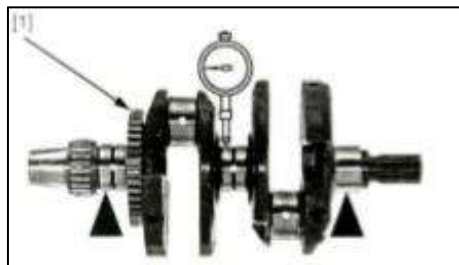

INSTALLATION:

Install the main journal bearing [1] and crank pin bearing [2] in their original positions.

NOTICE:

Do not change the position of the bearing bush. The bearing bush must be installed in the initial position, otherwise the correct oil film gap will be destroyed and the engine will be damaged. The inner surface of the main journal bearing bush located in the upper crankcase and the crank pin bushing located in the big end of the connecting rod will be smeared with oil. The end of the piston skirt is aligned with the edge of the cylinder block. As shown in the picture, apply engine oil to the thrust surface of the crankshaft.

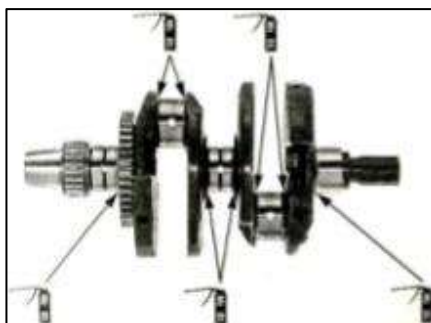
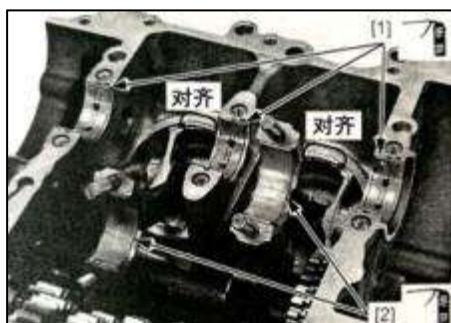

CRANKSHAFT/PISTON/CYLINDER/BALANCER

Align the groove at the end of the balance shaft with the protrusion of the upper crankcase.



Safely place the crankshaft [1] above the crankcase, with the "△" mark [2] on the active gear of the balance shaft facing the front of the engine, and then place the crank pin in the big end of the connecting rod (NOTICE Do not damage the crank pin, main journal and bush).

Install the crankshaft into the upper crankcase. When installing, make sure to place the balance shaft driven tooth indicator line [3] between the balance shaft master and follower tooth indicator lines [4], as shown in the picture.

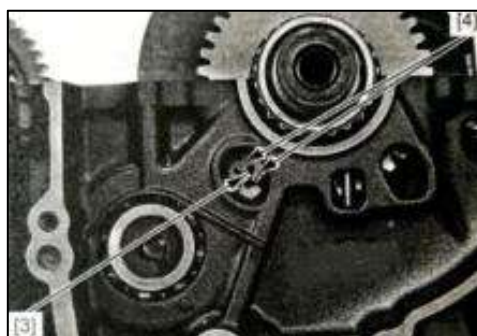
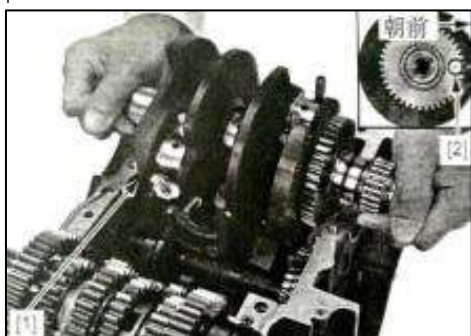

Place the big end of the connecting rod [1] in the crank pin.

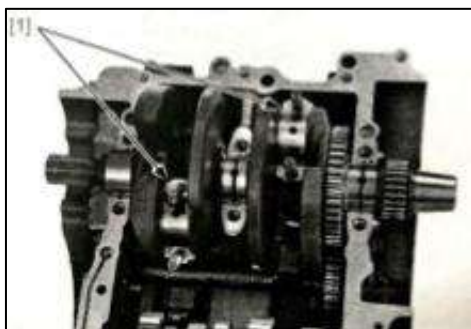

Clean the joint surface between the big end of the connecting rod and the connecting rod cover, and dry it with compressed air.



CRANKSHAFT/PISTON/CYLINDER/BALANCER

Apply engine oil to the inner surface of the crank pin bush on the connecting rod cover. Install the connecting rod cover by matching the inner diameter letter numbers on the connecting rod cover and the big end of the connecting rod [1].

NOTICE:

Make sure that each part is installed in its original location, as marked when removed.

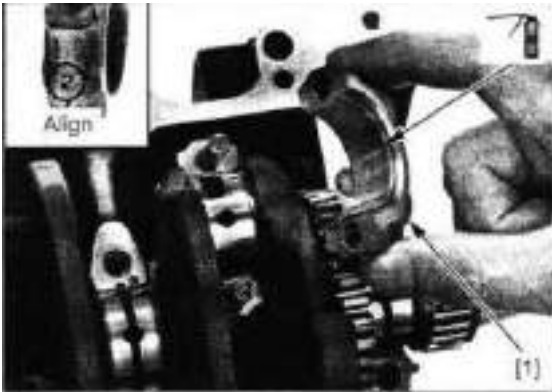

Apply engine oil to the thread and nut seat of the connecting rod cap nut. Install and tighten the connecting rod cap nut [1], and tighten it to the specified torque alternately in 2 or 3 times.

Torque: 33N·m

Assemble the upper and lower crankshaft crankcases.

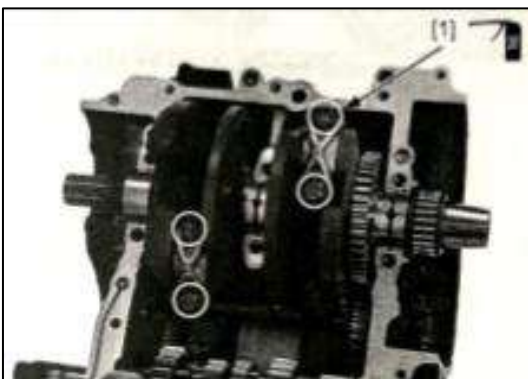

MAIN JOURNAL BEARING

NOTICE:

Do not change the position of the bearing bush. The bearing bush must be installed in the initial position, otherwise it will destroy the correct oil film clearance and cause damage to the engine.

Check the bearing

Remove the crankshaft. Check whether the main journal bearing bush [1] is abnormally worn or peeled off. Check whether the bearing boss [2] is damaged. If the main journal bearing bush is damaged, select the bearing bush for replacement.



Check the oil gap

Remove the crankshaft. Wipe off all the oil on the bearing bush and main journal. Install the crankshaft in the upper crankcase. On each main journal, place a plastic gap gauge [1] longitudinally avoiding the oil hole. (Check the oil gap Do not rotate the crankshaft during the process).



Install the positioning pin [1] into the upper crankcase [2].

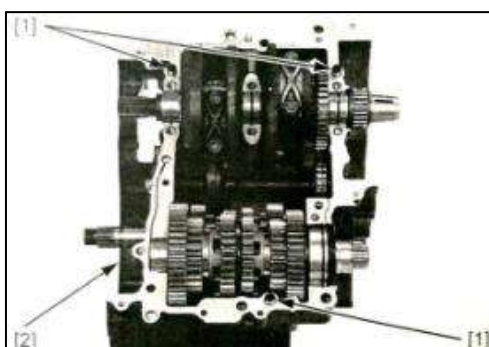

CRANKSHAFT/PISTON/CYLINDER/BALANCER

Install the lower crankcase [1] on the upper crankcase. Clean the main journal joint box bolts with solution (reuse), and dry them thoroughly. Apply engine oil to the threads and threaded seating surfaces of the main journal joint box bolts. Install the main journal joint Box bolt [2]. Ensure that the upper and lower crankcases are installed firmly. According to the number shown in the figure, fasten the main journal box bolts to the designated Torque in 2 or 3 times. Further tighten the main journal box by rotating 120° bolt.

Torque: 15N.m+120 °

Remove the main journal box bolts and the lower crankcase. Measure the maximum width of the plastic gap gauge after extrusion on each main journal to confirm the oil gap.

SERVICE LIMIT : 0.05 mm

If the oil gap exceeds the maintenance limit, select the bearing bush for replacement.

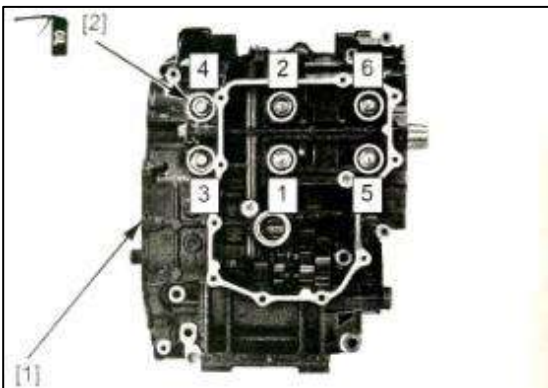

Selection of bearing

Record the letter number [1] of the inner diameter of the bearing bush mounting hole located on the left side of the upper crankcase, as shown in the figure (the letter (A, B or C) on the left side of the upper crankcase represents the inner diameter of the bearing bush mounting hole numbered from left to right).

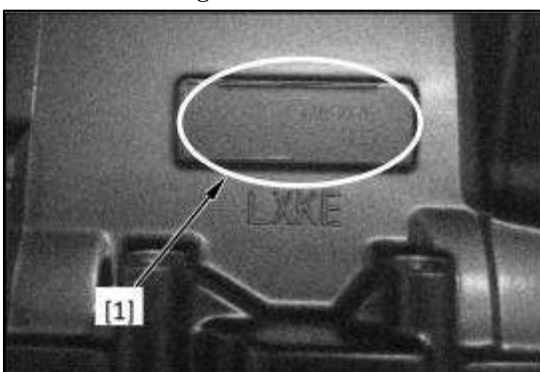

CRANKSHAFT/PISTON/CYLINDER/BALANCER

If you need to replace the crankshaft, record the corresponding number [1] located on the crankshaft counterweight (the numbers (1, 2 or 3) on the crankshaft counterweight represent the number of the main journal outer diameter in order from left to right).

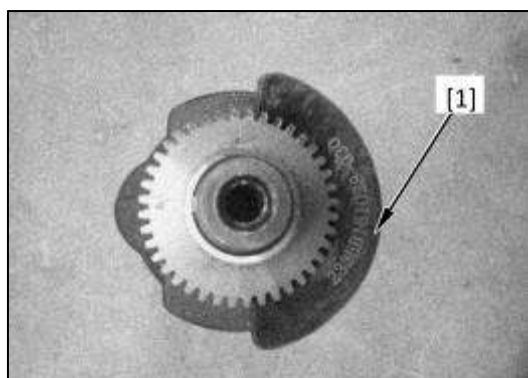

Cross-reference the main journal and bearing support codes to determine the replacement bearing color code [1].

MAIN JOURNAL BEARING THICKNESS:

A : Black: Thickest

B: Brown:

C: Green:

D: Yellow:

E : Pink: Thinnest

MAIN JOURNAL BEARING SELECTION TABLE:



		BEARING SUPPORT I. D. CODE			
		A	B	C	
		37.000-37.006mm (1.4567-1.4569in)	37.006-37.012mm (1.4569-1.4572in)	37.012-37.018mm (1.4572-1.4574in)	
MAIN JOURNAL O. D. CODE	1	34.000-34.006mm (1.3386-1.3388in)	E (Pink)	D (Yellow)	C (Green)
	2	33.994-34.000mm (1.3383-1.3386in)	D (Yellow)	C (Green)	B (Brown)
	3	33.988-33.994mm (1.3381-1.3383in)	C (Green)	B (Brown)	A (Black)

NOTICE: *After selecting the new bush, recheck the clearance with the plastic clearance gauge.*

CRANKSHAFT/PISTON/CYLINDER/BALANCER

Clean the outer surface of the bearing shell and the crankcase bearing shell mounting hole. Install the main journal bearing shell [1] into the crankcase bearing shell mounting hole, and align each boss and groove.



Crank pin bearing

NOTICE:

Do not change the position of the bearing bush. The bearing bush must be installed in the initial position, otherwise it will destroy the correct oil film clearance and cause damage to the engine

Remove the crankshaft.

Check whether the crank pin bearing [1] is abnormally worn or peeling. Check whether the bearing boss [2] is damaged. If the crank pin bearing is damaged, select the bearing to replace.



Check the oil gap

Remove the crankshaft. Clean the joint surface between the big end of the connecting rod and the connecting rod cover with solution, and dry it with compressed air



 CRANKSHAFT/PISTON/CYLINDER/BALANCER

Wipe off all the oil from the bearing bush and crank pin. Install the crankshaft into the upper crankcase. Install the big end of the connecting rod into the crank pin. On each main journal, place a plastic clearance gauge longitudinally avoiding the oil hole.[1] (In the process of checking the oil gap, do not rotate the crankshaft).

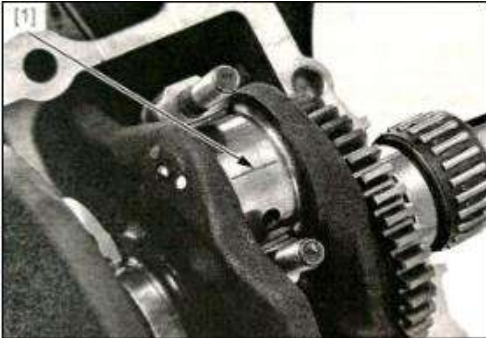

Install the connecting rod cover by matching the inner diameter letter number on the connecting rod cover and the big end of the connecting rod [1]

NOTICE:

Make sure that each part is installed in its original location, just like the logo when it was removed

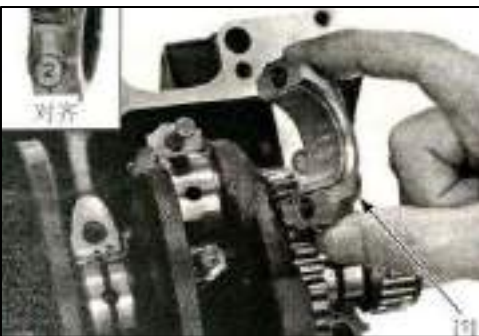

Apply engine oil to the thread and nut seat of the connecting rod cap nut. Install and tighten the connecting rod cap nut [1], and tighten it to the specified Torque alternately in 2 or 3 times.

Torque: 33N.m

Remove the connecting rod cover.

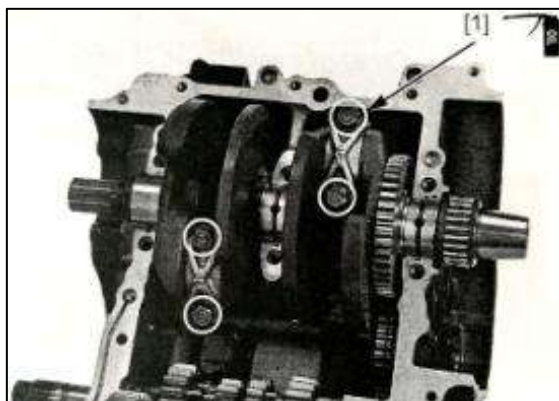

CRANKSHAFT/PISTON/CYLINDER/BALANCER

Measure the maximum width of the plastic gap gauge after extrusion on each crank pin to confirm the oil gap.

Maintenance limit: 0.06mm

If the oil gap exceeds the maintenance limit, select the correct bearing to replace



it.

Select bearing

Record the letter number on the inner diameter of the connecting rod [1] (the numbers (1, 2 or 3) on the connecting rod end represent the inner diameter of the connecting rod), or install the connecting rod cover on the connecting rod and measure the inner diameter without bearing bushes .

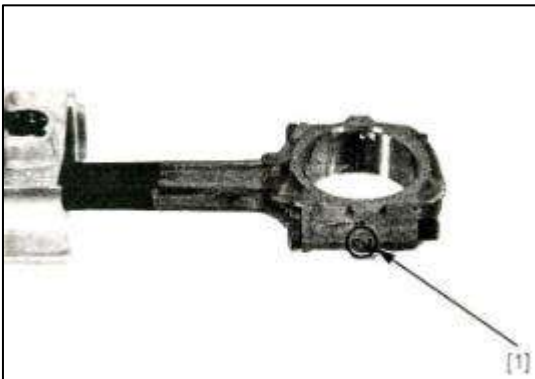

If the crankshaft needs to be replaced, record the corresponding number [1] located on the crankshaft counterweight (the letter (A, B, or C) on the crankshaft counterweight represents the crank pin outer diameter in the order of numbering from left to right). If repeated use Crankshaft, use a micrometer to measure the outer diameter of the crank pin

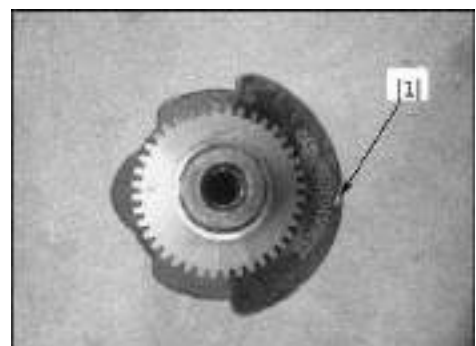

CRANKSHAFT/PISTON/CYLINDER/BALANCER

Cross-reference the connecting rod and crankpin codes to determine the replacement bearing color code [1].

CRANKPIN BEARING THICKNESS:

- A: Blue: Thickest
- B: Black: ↑
- C: Brown: ↔
- D: Green: ↓
- E: Yellow: Thinnest

CRANKPIN BEARING SELECTION TABLE



			CONNECTING ROD I. D. CODE		
			A	B	C
			39.000-39.006mm (1.5354-1.5357in)	39.006-39.012mm (1.5357-1.5359in)	39.012-39.018mm (1.5359-1.5361in)
CRANKPIN O. D. CODE	1	35.994-36.000mm (1.4171-1.4173in)	E (Yellow)	D (Green)	C (Brown)
	2	35.988-35.994mm (1.4168-1.4171in)	D (Green)	C (Brown)	B (Black)
	3	35.982-35.988mm (1.4166-1.4168in)	C (Brown)	B (Black)	A (Blue)

NOTICE: After selecting a new bearing shell, recheck the gap with a plastic gap gauge. Install bearing

Clean the outer surface of the bearing bush, the connecting rod cover and the big end of the connecting rod. Install the crank pin bush [1] into the connecting rod cover and the big end of the connecting rod, and align each boss and groove.

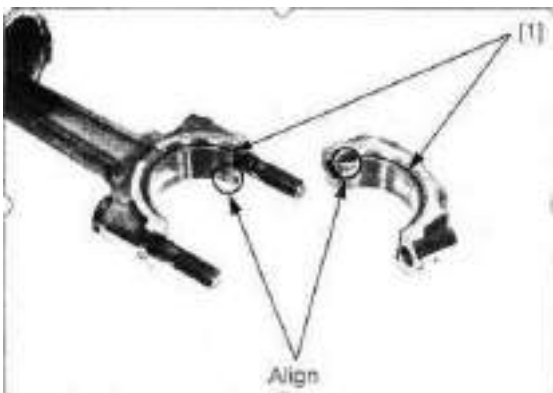

PISTON/CYLINDER

PISTON/CONNECTING ROD REMOVAL

NOTE

Before piston removal, place a clean shop towel around the connecting rod to prevent damaging the cylinder sleeve.

Do not try to remove the piston/connecting rod assembly from bottom of the cylinder; the assembly will get stuck in the gap between the cylinder liner and the upper crankcase. Do not interchange the bearing inserts. They must be installed in their original locations or the correct bearing oil clearance may not be obtained, resulting in engine damage.

Remove the following:

- countershaft
- crankshaft

Remove the piston/connecting rod assembly [1] from the top of the cylinder.

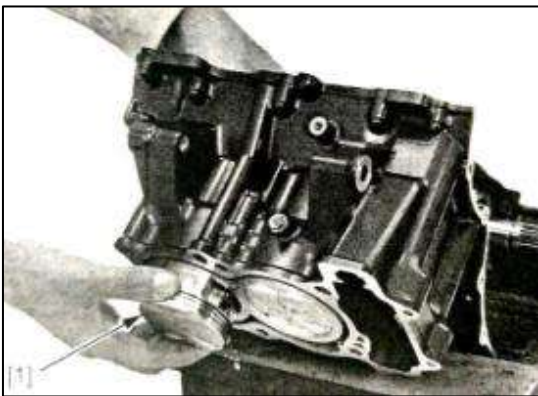

PISTON REMOVAL

Use tweezers to remove the wire retaining ring [1]. Push the piston pin [2] out of the piston [3] and the small end of the connecting rod [4], and then remove the piston.

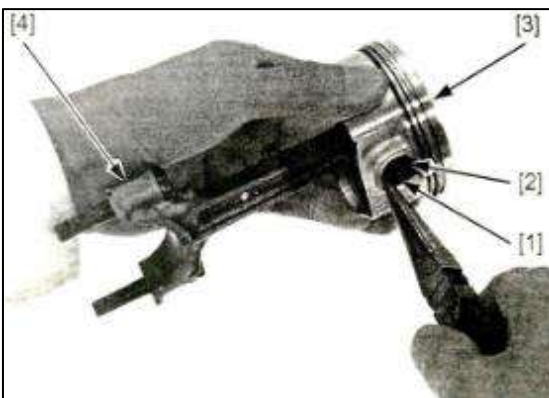

CRANKSHAFT/PISTON/CYLINDER/BALANCER

Remove the piston ring

Separate the ports of each piston ring, and then pull the ring upwards along the opposite side of the piston ring opening.

NOTICE:

Do not separate the ports too far to avoid damage to the piston ring. **NOTICE** Do not scratch the piston when removing the piston ring. Use the piston ring to be discarded to remove the carbon deposits in the piston ring groove.

NOTICE:

Do not use steel brushes to avoid scratching the piston ring.

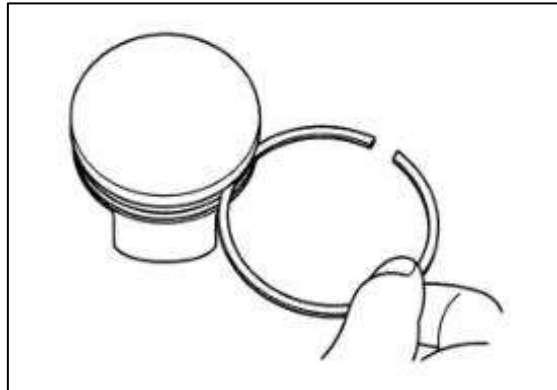
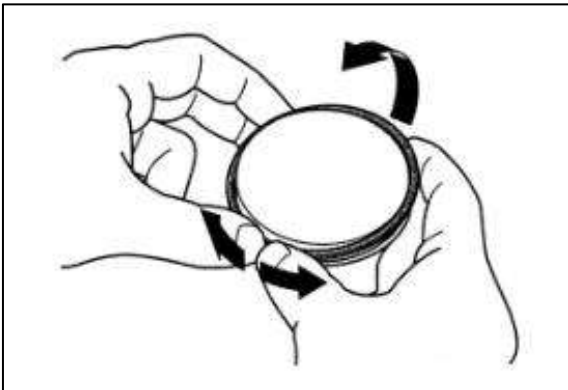
**INSPECTION**

Check the following parts for scratches, damage, abnormal wear, deformation, burns, and blockage of oil passages.

- Cylinder
- Piston
- Piston ring
- Piston pin
- Connecting rod small head

Measure each part and calculate the gap according to CRANKSHAFT/PISTON/CYLINDER/BALANCER technical specifications. Replace any parts that exceed the maintenance limit.

PISTON RING INSTALLATION

Thoroughly clean the piston ring groove and install the piston ring.

Apply engine oil to the entire surface of the piston ring and the piston ring groove.

During the installation process, prevent damage to the piston and piston ring.

When installing, put the marked side of the piston ring up.

- "ATG" mark: a ring [1].

- "A2" mark: Second Ring [2].

When installing the oil ring assembly [3], first install the backing ring [4], and then install the wiper ring [5].

Cross the piston ring openings 120° . Stagger the opening positions of the wiper ring as shown in the figure.

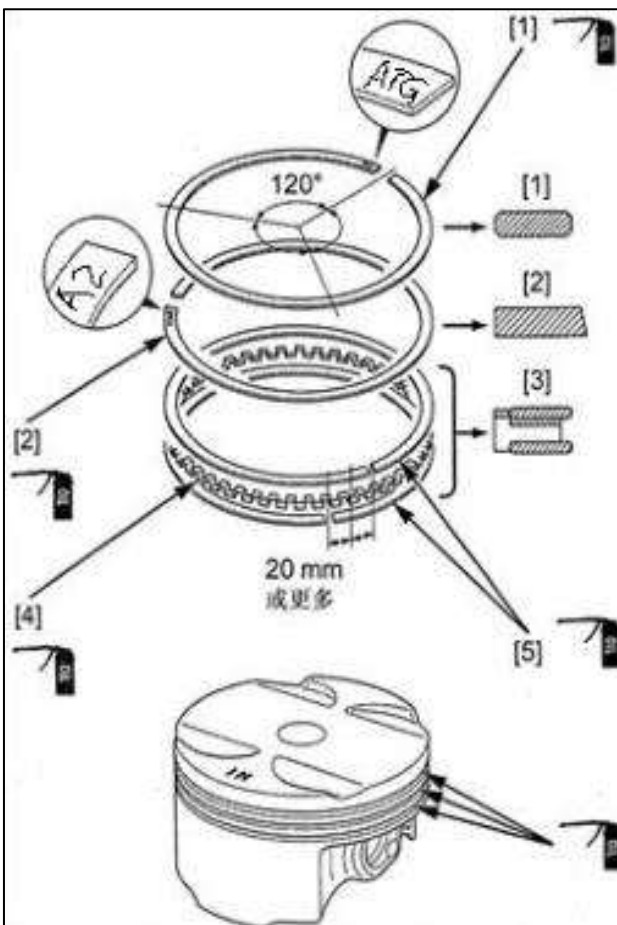

CRANKSHAFT/PISTON/CYLINDER/BALANCER

PISTON INSTALLATION

Install the crank pin bush in the original position. Apply oil to the inner surface of the piston pin hole. Apply oil to the inner surface of the small end of the connecting rod. When matching the piston [1] and connecting rod [2] assembly, set the boss of the crank pin bearing [3] Towards the direction of the piston "IN" mark [4]. Apply oil to the outer surface of the piston pin. Install the piston pin [1] and use a new wire retaining ring [2] to fix it.

NOTICE:

Ensure that the wire retaining ring is installed in place. Do not align the opening of the wire retaining ring with the notch of the piston.

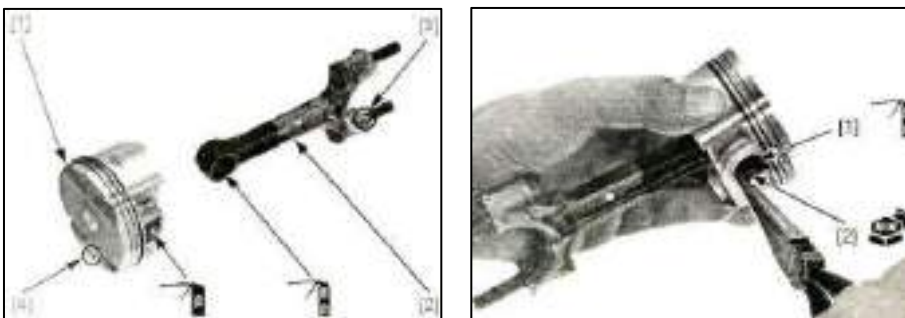

Apply engine oil to the cylinder wall and piston thrust surface. Use commercially available piston ring compression tools to install the piston/connecting rod assembly [1] into the cylinder (when installing the piston/connecting rod assembly, the "IN" on the piston "Mark toward the air intake direction). When installing reusable connecting rods, they must be installed in their original positions.

NOTICE:

When installing the piston, be careful not to damage the upper surface of the piston, especially the part that matches the cylinder hole. be careful not to damage the cylinder liner and crank pin by the connecting rod. Use a plastic hammer or similar tool to tap the piston into the cylinder. Medium (make sure that the piston ring compression tool is placed flat on the upper surface of the cylinder). Install the following parts:

- Crankshaft
- Balance shaft

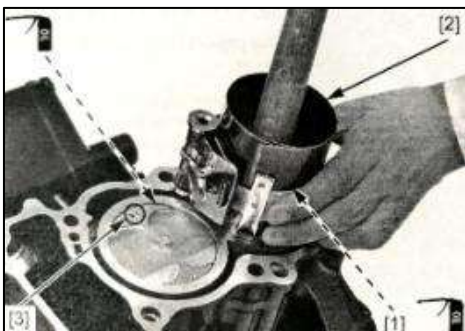

CRANKSHAFT/PISTON/CYLINDER/BALANCER

PISTON OIL JET

REMOVAL/INSTALLATION

Remove the piston/connecting rod assembly. Push the nozzle outward from the cylinder side to the main journal side (NOTICE do not damage the nozzle oil hole). Remove the O-ring on the nozzle. Thoroughly clean the nozzle with solution. Check if the nozzle is blocked. If necessary, replace the nozzle. Use compressed air to blow off the upper crankcase oil passage and the nozzle oil passage. Install a new O-ring at the nozzle groove and apply engine oil before installation. Install the nozzle into the upper crankcase until the nozzle is completely in place. When installing, align the nozzle boss and the crankcase groove. Install the removed parts in the reverse order of the removal sequence.

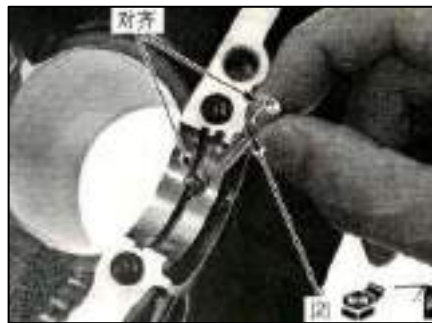

BALANCER

REMOVAL

Remove the piston/connecting rod assembly. Remove the bolt [1] and balance shaft/spindle right bearing pressure plate [2].



Rotate the balance shaft so that the left balance weight [1] faces upwards. Slide the balance shaft to the right in the upper crankcase, and then remove the balance shaft right bearing [2].



CRANKSHAFT/PISTON/CYLINDER/BALANCER

Remove balance shaft [1].

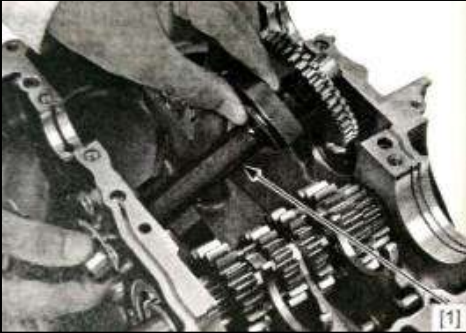

INSPECTION

Check the following parts for scratches, damage, abnormal wear and deformation, and replace parts if necessary.

- Balance shaft driven teeth
- Balance shaft driven teeth auxiliary teeth
- Driven tooth pressure spring
- Balance shaft
- Balance shaft bearing

Replace the bearing on the left side of the balance shaft

Tap out the left balance shaft bearing from the upper crankcase.



Install a new balance shaft left bearing [1] in the upper crankcase using a special tool and tap gently until the bearing is completely in place (tap gently at right angles with the marked side of the bearing facing up).

CRANKSHAFT/PISTON/CYLINDER/BALANCER

INSTALLATION

Apply oil to the left balance shaft bearing [1]. Install the balance shaft [2] into the upper crankcase with the left balance block [3] facing up.

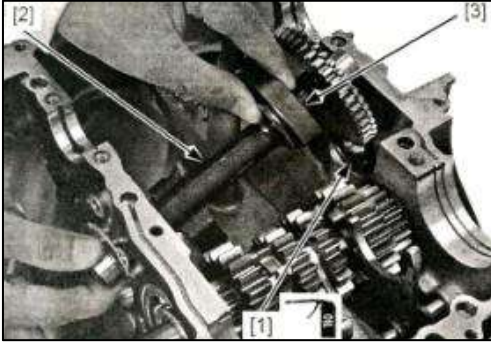

Apply oil to the right bearing of the balance shaft. Install the balance shaft right bearing [1] into the upper crankcase (bearing mounted with marked side up).



Apply thread glue to the thread of the balance shaft/spindle right bearing plate bolt. Install balance shaft/spindle right bearing platen [1] and platen bolt [2]. Tighten platen bolt to rated torque.

Torque: 12 n. m

Install the piston/connecting rod assembly.

15.ENGINE REMOVAL/INSTALLATION

SERVICE INFORMATION -----15-1

ENGINE REMOVAL----- 15-3

COMPONENT LOCATION ----- 15-2

ENGINE INSTALLATION----- 15-7

SERVICE INFORMATION

GENERAL

A hoist or equivalent is required to support the motorcycle when removing and installing the engine.

A floor jack or other adjustable support is required to support and maneuver the engine.

NOTICE:

Do not use oil filters as jacking points. When removing/installing the engine, wrap the frame around the engine with tape in advance to protect the frame. When installing the engine, tighten the engine fasteners to the Torque in the specified sequence. If you install the Torque in the wrong order or in the wrong Torque, loosen all fasteners and tighten them to the specified Torque in the correct order. When the engine is mounted in the frame, the following parts can be serviced

- Starting motor
- Throttle body air filter housing assembly
- Water pump
- Oil pump
- Oil filter
- Camshaft
- Rocker
- CAM chain tensioner tappet
- Clutch
- Primary driving teeth
- Shift mechanism
- Magneto spindles and triggers
- Magneto rotor
- Start clutch

The following parts require engine removal for servicing

- Cylinder head/valve
- Transmission shaft
- The crankshaft
- Piston/cylinder
- Balance shaft

ENGINE REMOVAL/INSTALLATION

COMPONENT LOCATION

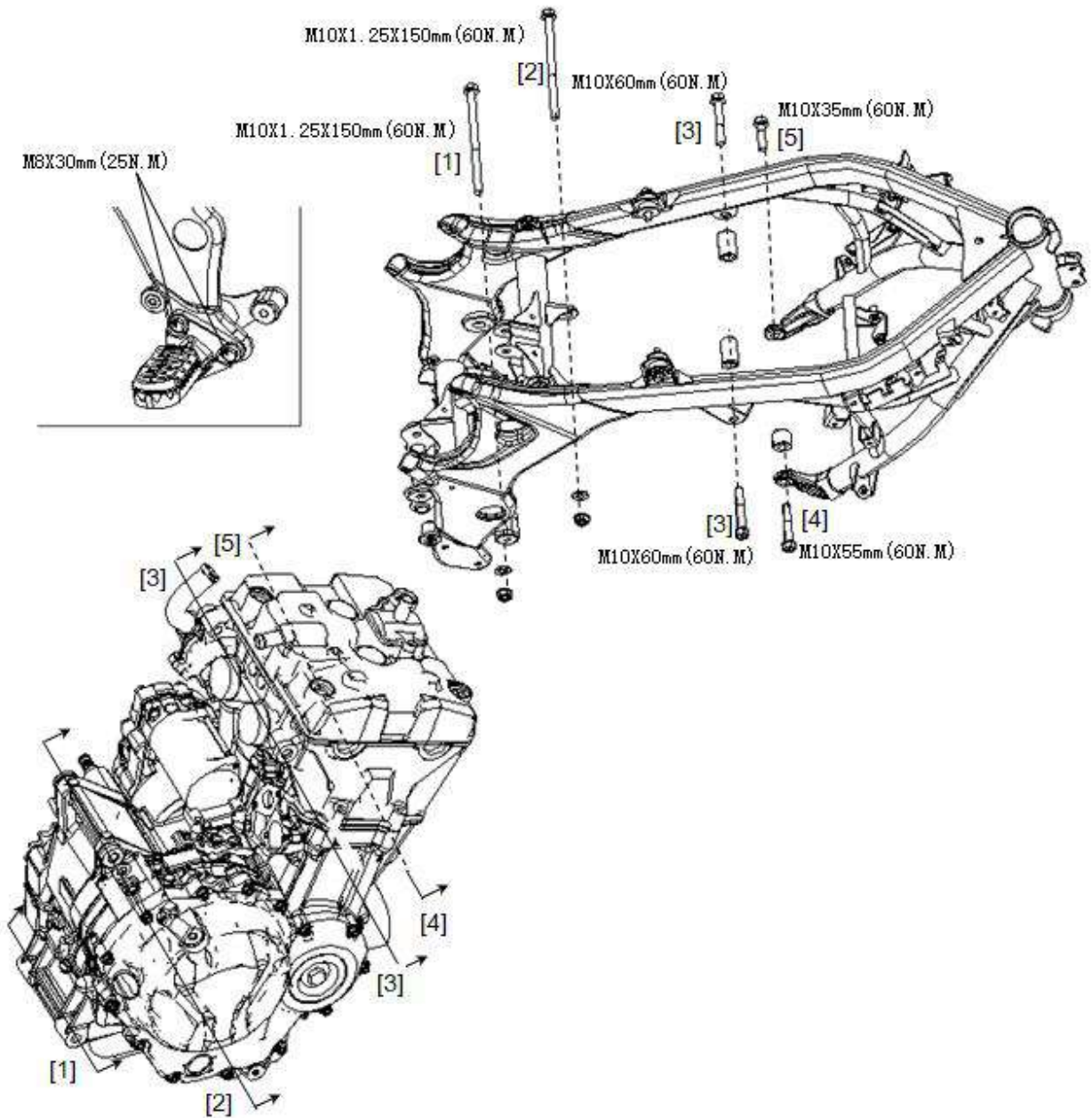

ENGINE REMOVAL

Drain the engine oil; drain the coolant; completely loosen the chain

Disassemble the following parts:

- Engine sprocket cover
- exhaust pipe
- Engine anti-scald cover
- Engine lower guard plate

Disconnect the CKP sensor 3P (white) connector [1]; disconnect the gear connector [2]; disconnect the wheel speed sensor connector [3]

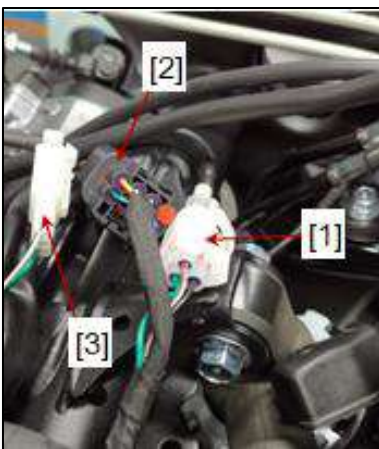

Remove the bolt [1] and the clutch cable holder [2], and then disconnect the clutch cable [3] from the clutch tappet arm [4].



ENGINE REMOVAL/INSTALLATION

Loosen the rubber cover [1] from the engine oil pressure (EOP) switch [2], remove the terminal screw [3] and disconnect the switch wire [4]

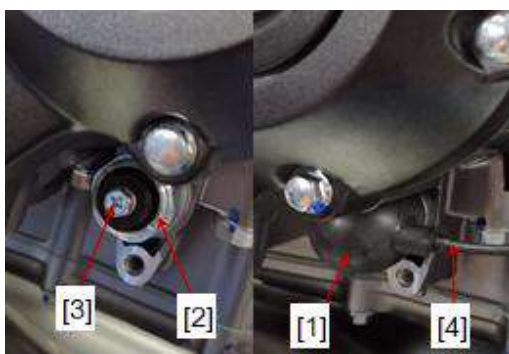

Remove the bolt [1].

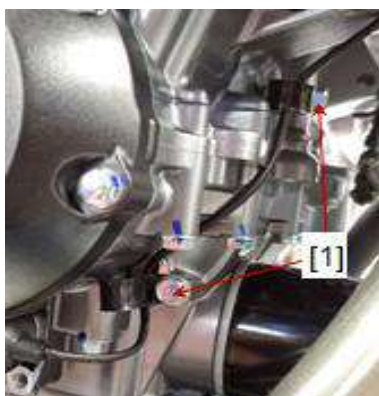

Disconnect the 8P (black) connector of the engine harness [1]. Loosen the hose clamp [2] and disconnect the hose from the upper radiator [3].

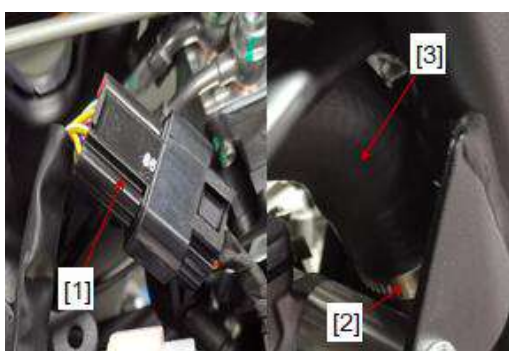

Loosen the hose clamp [1] and disconnect the lower hose of the radiator from the water pump [2]

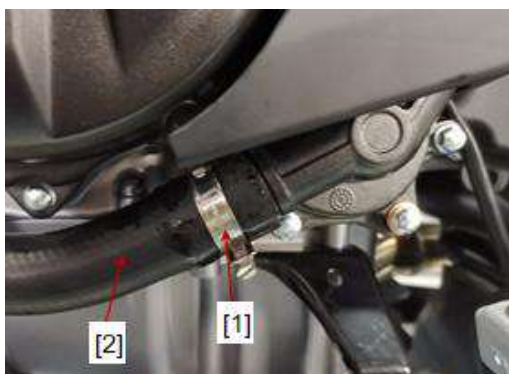

ENGINE REMOVAL/INSTALLATION

Remove the sprocket cover; remove the small sprocket bolt [1], washer [2] and small sprocket [3].



Use a crane or equivalent to firmly support the motorcycle. Put the jack or others adjustable bracket under the engine

NOTICE:

The height of the jack must be adjusted continuously to relieve the stress and facilitate the removal of the bolts. Remove the bolts [1] and bushings [2] of the engine front suspension

Do not use the oil filter as a jacking point



Remove the upper suspension bolt [1] and bushing [2] of the engine

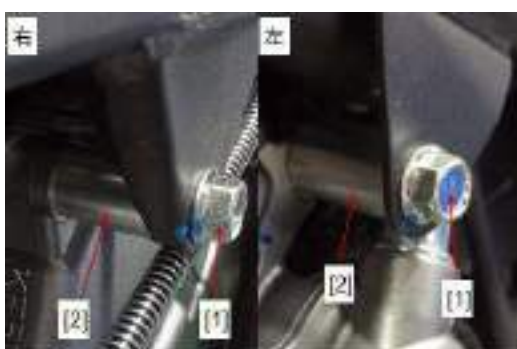

ENGINE REMOVAL/INSTALLATION

Remove the nut [1], washer [2] and bolt [3] of the lower engine rear suspension; remove the nut [2], washer [5] and bolt [6] of the upper engine rear suspension

NOTICE:

Raise the rear of the motorcycle so that the rear wheel is 150 mm (6 in) off the ground to help disassemble the engine. Carefully lower the jack or adjustable bracket, and then remove the engine from the frame.

During the engine disassembly process, firmly fix the engine, being careful not to damage the frame and engine.

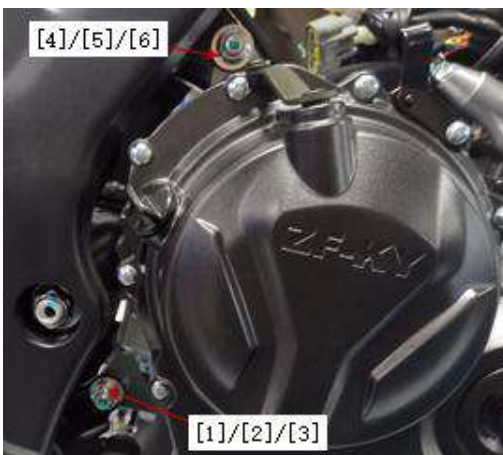

ENGINE REMOVAL/INSTALLATION

Engine Installation

NOTICE:

The oil filter is not suitable as the apex. The height of the jack must be constantly adjusted to reduce pressure and facilitate bolt installation. Carefully align the installation point with the jack to prevent damage to the engine, frame, radiator, hoses, wires and cables. For the rear part of the high motorcycle, make the rear wheel 150mm (6in) off the ground, and place the engine on the jack or others adjustable bracket under the frame. Align the bolt holes of the front engine suspension with the frame mounting seat, and then install the bolts and Shaft sleeve. Lift the engine while rotating upwards at the rear to install the others hanger bolts and sleeves. Install the rear engine suspension nuts with washers. Tighten the bolts and nuts to the specified Torque in the order indicated, as shown in the picture Show.

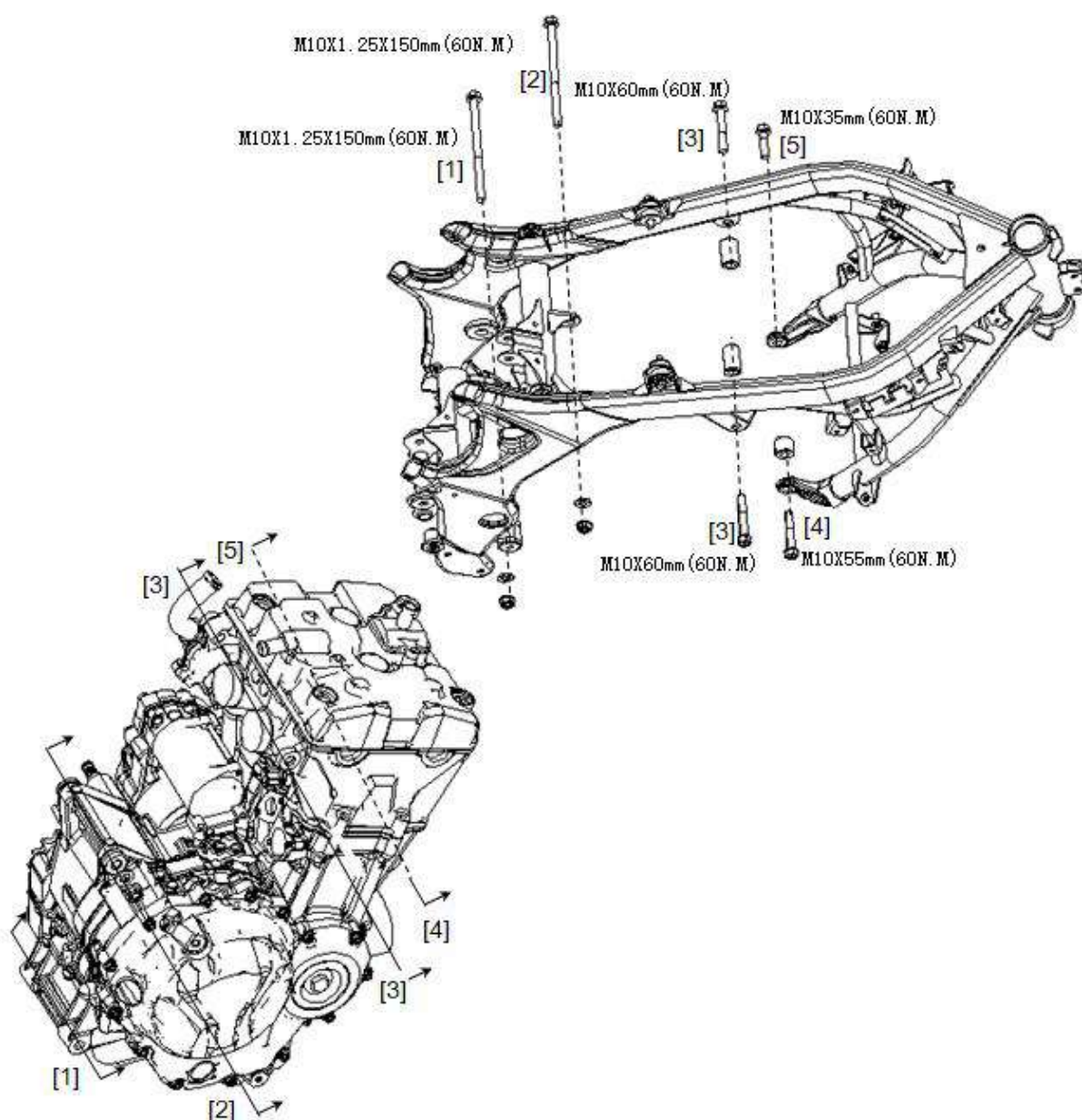

ENGINE REMOVAL/INSTALLATION

Install the disassembled parts in the reverse order of disassembly

Torque:

Right rider footpeg bracket bolt:

22 N.m (2.2 kgf.m, 16 lbf.ft)

Drive sprocket bolt:

50 N.m (5.0 kgf.m, 37 lbf.ft)

EOP switch terminal screw:

1.0 N.m (0.1 kgf.m, 0.7 lbf.ft)

Right crankcase cover bolt:

12 N.m (1.2 kgf.m, 9 lbf.ft)

NOTICE:

Install the drive sprocket [1] with the "OUT" mark [2] facing outward; align the clutch cable bracket hole with the right crankcase cover boss

The adjustments are as follows:

- Free play of throttle handle
- Free play of the clutch lever
- Loose transmission chain

Fill the engine with recommended engine oil, fill and drain the COOLING SYSTEM, check the exhaust system and COOLING SYSTEM for leaks

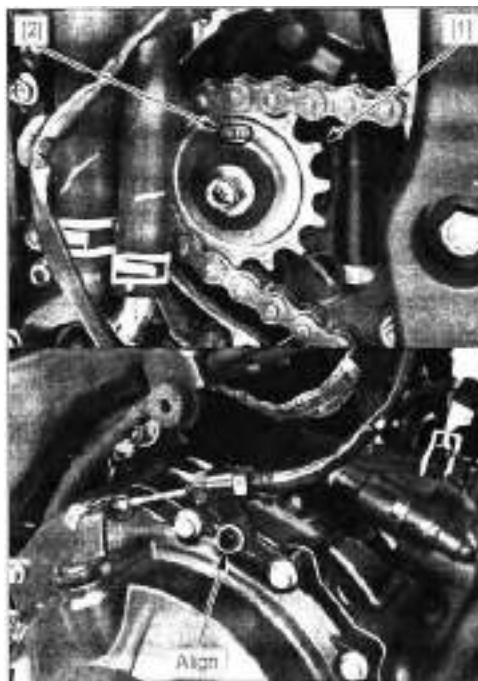

16.FRONT WHEEL/SUSPENSION/STEERING

SERVICE INFORMATION----- 16-1

HANDLEBAR ----- 16-5

TROUBLESHOOTING -----16-3

FRONT WHEEL----- 16-9

COMPONENT LOCATION -----16-4

FRONT SHOCK ABSORBER----- 16-13

STEERING STEM -----16-20

SERVICE INFORMATION**GENERAL**

- A hoist or equivalent is required to support the motorcycle when servicing the front wheel, fork and steering stem.
- A contaminated brake disc or pad reduces stopping power. Discard contaminated pads and clean a contaminated disc with a high quality brake degreasing agent.
- Do not operate the brake lever after removing the front wheel.
- Use only tires marked "TUBELESS" and tubeless valves on rim marked "FOR TUBELESS".
- After the front wheel installation, check the brake operation by applying the brake lever.
- After the front wheel installation, perform the air gap inspection.
- For brake system service

FRONT WHEEL/SUSPENSION/STEERING

TROUBLESHOOTING**Hard steering**

- Insufficient tire pressure
- Faulty tire
- Steering stem adjustment nut too tight
- Worn or damaged steering beatings
- Worn or damaged steering beating races
- Bent steering stem

Steers to one side or does not track straight

- Bent axle
- Wheel installed incorrectly
- Worn or damaged wheel bearings
- Bent fork leg
- Damaged or loose steering bearings
- Damaged frame
- Faulty wheel bearin

Front wheel wobbles

- Bent rim
- Faulty tire
- Worn or damaged wheel bearings
- Loose axle
- Unbalanced tire and wheel

Wheel hard to turn

- Faulty wheel bearings
- Bent axle

WHEEL/SUSPENSION/STEERING

The Brake resistance

Soft suspension

- Low tire pressure
- Weak fork spring
- Low fluid level in fork
- Incorrect fork fluid weight (low viscosity)

Stiff suspension

- High tire pressure
- Bent fork tube
- Fork slider binds
- High fluid level in fork
- Incorrect fork fluid weight (high viscosity)
- Clogged fork fluid passage

Front suspension noise

- Loose fork fasteners
- Incorrect fork fluid weight (low viscosity)
- Worn slider of fork tube bushing

HANDLEBAR**REMOVAL**

Remove the rearview mirror.

Remove the following parts:

- clutch switch joint [1]
- two bolts [2]
- clutch handle clamp [3]
- clutch grip clamp [4]



- two screws [1]
- right hand switch housing [2]
- bolt [3] (balance weight [4])
- right hand glue [5]

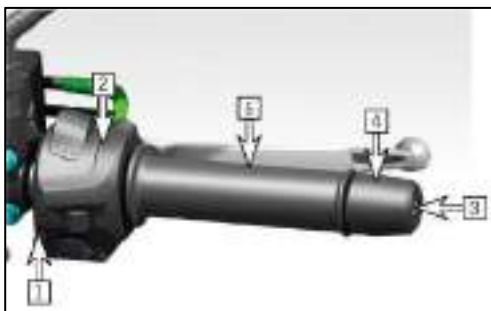

- Two bolts [2]
- Brake Handle Holder [3]

-front brake pump[4]



- two screws[1]
- left hand switch housing[2]

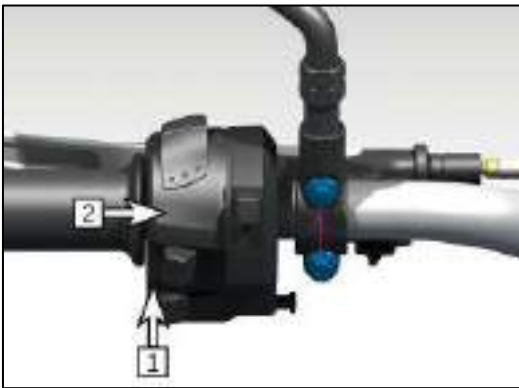

NOTICE:

Keep the tank upright to prevent air from entering the hydraulic system

- 4 bolts [1]
- Direction handle clamp [2]
- Handle tube [3]



FRONT WHEEL/SUSPENSION/STEERING

- Throttle handle glue [1] (from the handle)
- Throttle cable[2]
- Handle switch housing [3] (throttle handle)

**INSTALLATION**

Clean the sliding surface of the throttle handle glue [1] and the handle tube [2], and apply grease to the upper part of the throttle cable and the roll-up area. Connect the throttle cable [3] to the throttle handle and connect the handle tube Place it in the switch housing [4] Install the throttle handle glue on the handle.

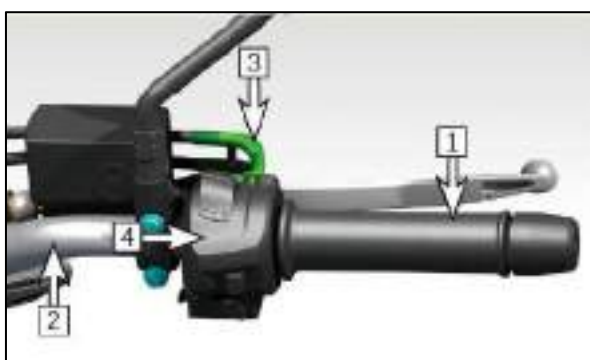

Install the handlebar [1] and the upper clamp [2] of the steering handle. First tighten the rear bolt [4], and then tighten the front bolt [3] to the specified torque.

Torque: 22N.m (2.2 kgf.m, 16 lbf.ft)



NOTICE: Align the stamping mark with the edge of the connecting plate

FRONT WHEEL/SUSPENSION/STEERING

Before installing the Brake pump [1] and Brake handle holder [2], first tighten the upper bolt [3], and then tighten the lower bolt [4] to the specified Torque.

Torque: 8N.m (0.8 kgf.m, 6 lbf.ft)

Connect the Brake light switch connector.



Install the handlebar counterweight [1], align the plane and tighten the screw [2], while firmly fixing the counterweight



Clean the surface of the left-hand handle glue [1] and the outer surface of the handle tube [2]. Apply the handle adhesive to the inner surface of the handle and the outer surface of the handle. Wait 3-5 minutes, then install the handle glue; turn the handle to make the adhesive Evenly apply and install the handlebar counterweight [3] and tighten the screws [4] as described above.



Install the clutch lever bracket [1] and the clutch lever holder [2], first tighten the upper bolt [3], and then tighten the lower bolt [4]. Connect the clutch switch connector [5]

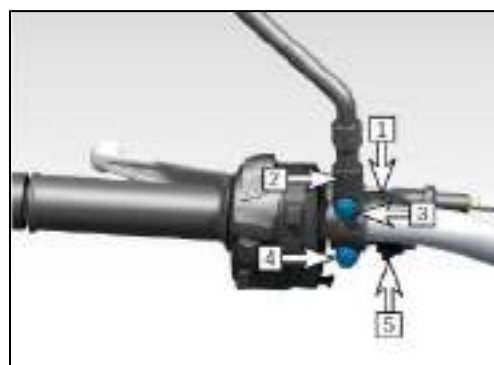

INSTALL REARVIEW MIRROR

Check the following:

- Clutch handle free clearance
- Free stroke of throttle handle

FRONTWHEEL

REMOVAL/INSTALLATIONNOTICE:

Do not operate the Brake handle after disassembling the wheel. Be careful not to bend or damage the ring gear [1]. Remove the front fender; remove the bolt [2] and the front wheel speed sensor [3]; remove the 2 Brake caliper bolts [4] ; Loosen the shaft clamping bolt [5] and the front shock absorber [6]; use a crane or equivalent to firmly support the motorcycle and lift the front wheel off the ground. Pull out the shaft and remove the front wheel.



Place the wheel between the front shock absorbers. Carefully align the axle holes and insert the axle from the right. Tighten the axle to the specified torque.

Torque: 70 N.m (7.0 kgf.m, 52 lbf.ft)

When the front Brake device is engaged, move up and down before damping several times to put the shaft in place and check the working condition of the Brake device. Tighten the shaft clamping bolt to the specified torque.

Torque: 22 N.m (2.2 kgf.m, 16 lbf.ft)

FRONT WHEEL/SUSPENSION/STEERING

Wipe the tip and installation area of the front wheel speed sensor [1] to remove any foreign matter. Install the wheel speed sensor and tighten the bolt [2]. Check the air gap between the wheel speed sensor and the ring gear

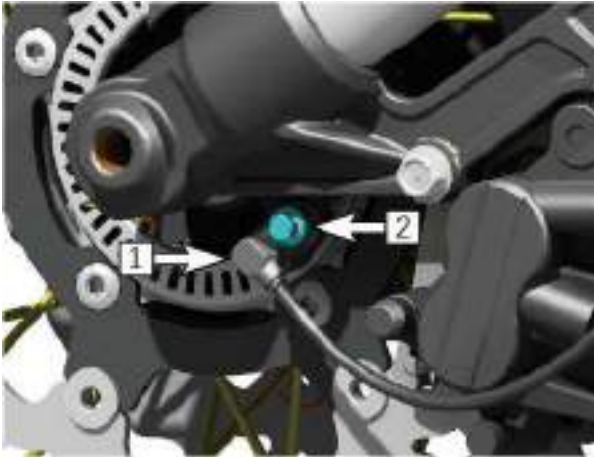

INSPECTION

Use your fingers to turn the inner ring of each bearing. The bearing should rotate smoothly and quietly. Also check whether the outer ring of the bearing fits closely with the hub. If the bearing does not rotate smoothly, rotates smoothly, or is not firmly installed in the hub, replace the bearing. Check the following parts for damage, abnormal wear, deformation or bending.

- Front shock absorption
- Spokes
- Rim

Measure each part according to the front wheel/suspension/steering specifications. If the usage limit is exceeded, replace any parts.

BEARING REPLACEMENT

Install the disassembly head into the bearing. Install the bearing puller shaft and knock the bearing out of the hub.

Remove the retaining ring and knock out another bearing



Insert the new right bearing (Brake disc side) vertically with the marked side up until it is fully seated. Push the new left bearing vertically with the marked side up until it is fully seated.

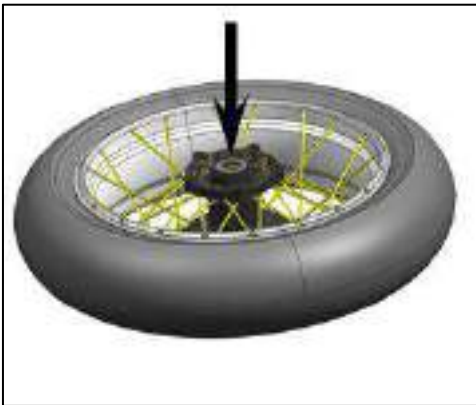

 FRONT WHEEL/SUSPENSION/STEERING

WHEEL BALANCE
NOTICE:

When installing the tire, the arrow mark [1] is facing the direction of rotation. In order to achieve the best balance, the tire balance mark [2] (weight point: paint spot on the side wall) is located next to the valve [3]; reinstall the tire if necessary. When reinstalling the front tires, you must check the wheel balance. This motorcycle should use a stick-type counterweight; use a real Excelle counterweight. Before installing the counterweight, thoroughly remove the adhesive on the rim and clean it with a degreasing agent. Place a new balance hammer; be careful not to scratch the surface of the rim. When installing, do not touch the adhesive surface of the counterweight with your bare hands. Every time you remove the counterweight, replace the counterweight with a new one; do not reuse them.



Install the wheel, tire and Brake disc assembly on the inspection table [1]. Turn the wheel to stop it. Mark the lowest (heaviest) part of the wheel with chalk. Do this two to three times to verify the heaviest Area. If the wheel is in a balanced state, it will not continue to stop at the same position

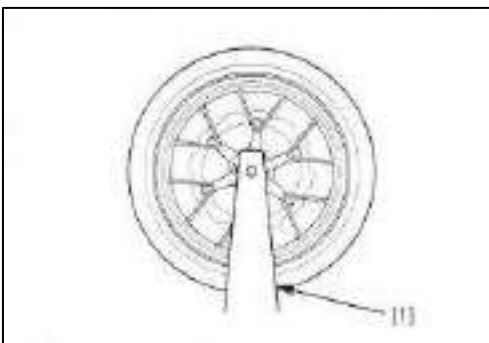

To balance the wheel, install the wheel counterweight [1] on the highest side of the rim, the side opposite to the chalk mark. Add enough weight so that the wheel no longer stops at the same position when it is spinning. Do not add more than 60 grams (2.1 oz) weight. Press the heavy object firmly with your hand to ensure that the heavy object does not fall off the rim.

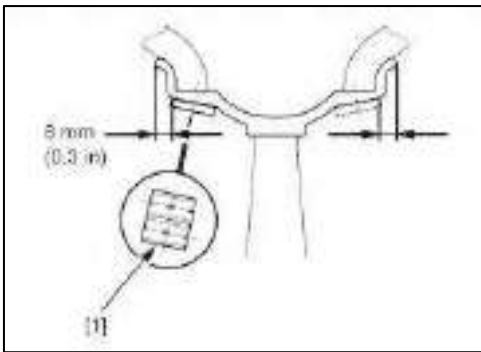
**NOTICE:**

The weight is fixed at 8 mm (0.3 in) from the side of the rim, and the direction is shown in the figure. If the weight exceeds 10g (0.4oz), install the same number of balance weights on the right and left symmetrical positions

Front Shock Absorber

Remove the following:

- Front wheel
- Front mudguard

Remove the two mounting bolts [1] and the front Brake pliers [2] (only the right front shock absorber)

NOTICE:

Support the Brake pliers so that it will not hang on the Brake head. Do not twist the brake hose; keep the reservoir upright to prevent air from entering the hydraulic system



Loosen Brake hose [1] (front right shock absorption only) from clamp [2]. Remove stop ring [3]. Loosen the clamping bolt [4] and remove the handle [5] from the fork tube.



FRONT WHEEL/SUSPENSION/STEERING

Loosen the upper plate clamp bolt [1]. When the front shock absorber is ready for disassembly, loosen the fork cover [2], but do not remove it. Firmly support the shock absorption [3]. Loosen the clamping bolt of the lower plate [4] and pull the fork leg; Then remove it from the top and bottom straps.

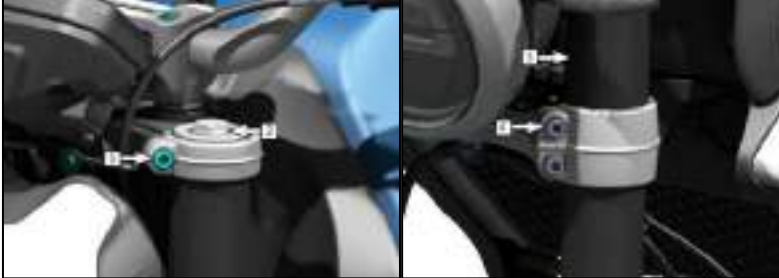

INSTALLATION

Mark the fork tube with a marker at the height specified below. The shock absorption [1] is inserted into the bottom and top Bridges so that the shock absorption reaches the specified height from the top bridge (marked), and then the clamp bolts are temporarily tightened. Top bridge lug to fork end; 1.0mm (0.04 in)

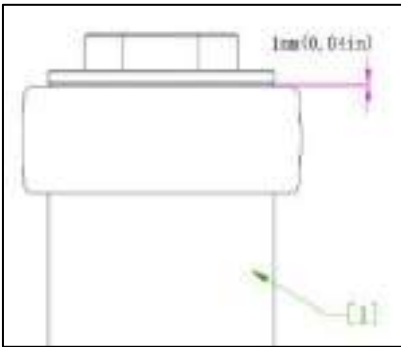

Tighten the lower plate clamping bolt [1] to the specified torque.

Torque: 22 N.m (2.2 kgf.m, 16 lbf.ft)

If the fork cover [2] is removed, tighten it to the specified torque.

Torque: 22 N.m (2.2 kgf.m, 16 lbf.ft)

Tighten the upper plate clamping bolt [3] to the specified torque.

Torque: 22 N.m (2.2 kgf.m, 16 lbf.ft)



FRONT WHEEL/SUSPENSION/STEERING

Install handlebars [1] on the fork tube so that the boss is aligned with the upper connecting plate slot. Ensure that the handlebar frame is fully secured to the tie at the top, push the handlebar forward so that the boss contacts the inside of the groove, then tighten the clamping bolts [2] to the specified torque.

Torque: 22 N.m (2.2 kgf.m, 16 lbf.ft)

Install the stop ring [3] into the slot of the fork tube. Install Brake hose [4] into clamp [5].

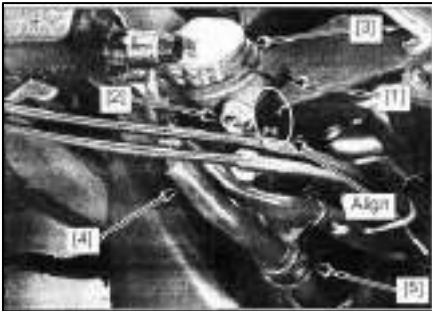

Install the Brake tubing into the line card, install the Brake clamp [2] with the new mounting bolt [1], and tighten it to the specified torque.

Torque: 22 N.m (2.2kgf.m.16 lbf.ft)



INSTALL THE FOLLOWING COMPONENTS:

- the front wheel
- fenders

DISASSEMBLY

First, loosen the big nut [1] on the damping outer cylinder body when the upper coupling plate is fixed by using an air wrench or a plum spanner



FRONT WHEEL/SUSPENSION/STEERING

Remove the front shock absorber from the car



Hold the shock-absorbing outer cylinder body in the left hand, and take a flat-head screwdriver in the right hand between the dustproof oil seal and the shock-absorbing outer cylinder body gently pry open the dust seal and the shock-absorbing outer cylinder body



Hold the shock absorption outer cylinder body with the left hand, take the right hand screwdriver gently pried open the spring at the oil seal



Tighten the nut on the upper end of the damping outer cylinder downward with an air gun or 14# plum spanner until the gap is about 5MM with the big nut on the lower end of 22#



FRONT WHEEL/SUSPENSION/STEERING

The right hand with an adjustable wrench stuck the shock absorption core, the left hand with an air gun or plum spanner to remove the large nut on the shock absorption cylinder body, carefully pour out the shock absorption oil

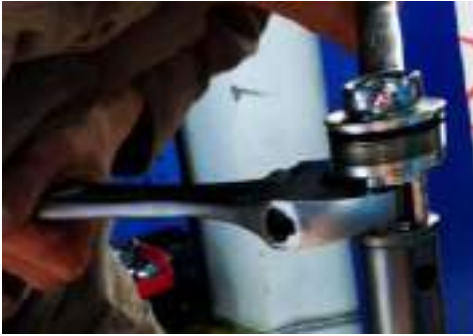

Pull the fork tube out of the fork slider by pulling it back and forth several times quickly

REMOVE THE FOLLOWING COMPONENTS:

- bushing
- Flat pad
- Oil seal
- Circlip



FRONT WHEEL/SUSPENSION/STEERING

INSPECTION

Check the following parts for damage, abnormal wear, bending, deformation, scratches, and Teflon coating wear

- Shock absorbing fork tube
- Shock absorber
- Damping spring
- Piston barrel/rod
- Oil lock
- Bushing
- Gasket
- Dust seal

Measure each part according to the front wheel/suspension/steering system specifications. If the part exceeds the service limit, please replace it.

ASSEMBLY

Before assembling, clean all parts with a high-flammability or non-flammable solvent and wipe them off completely

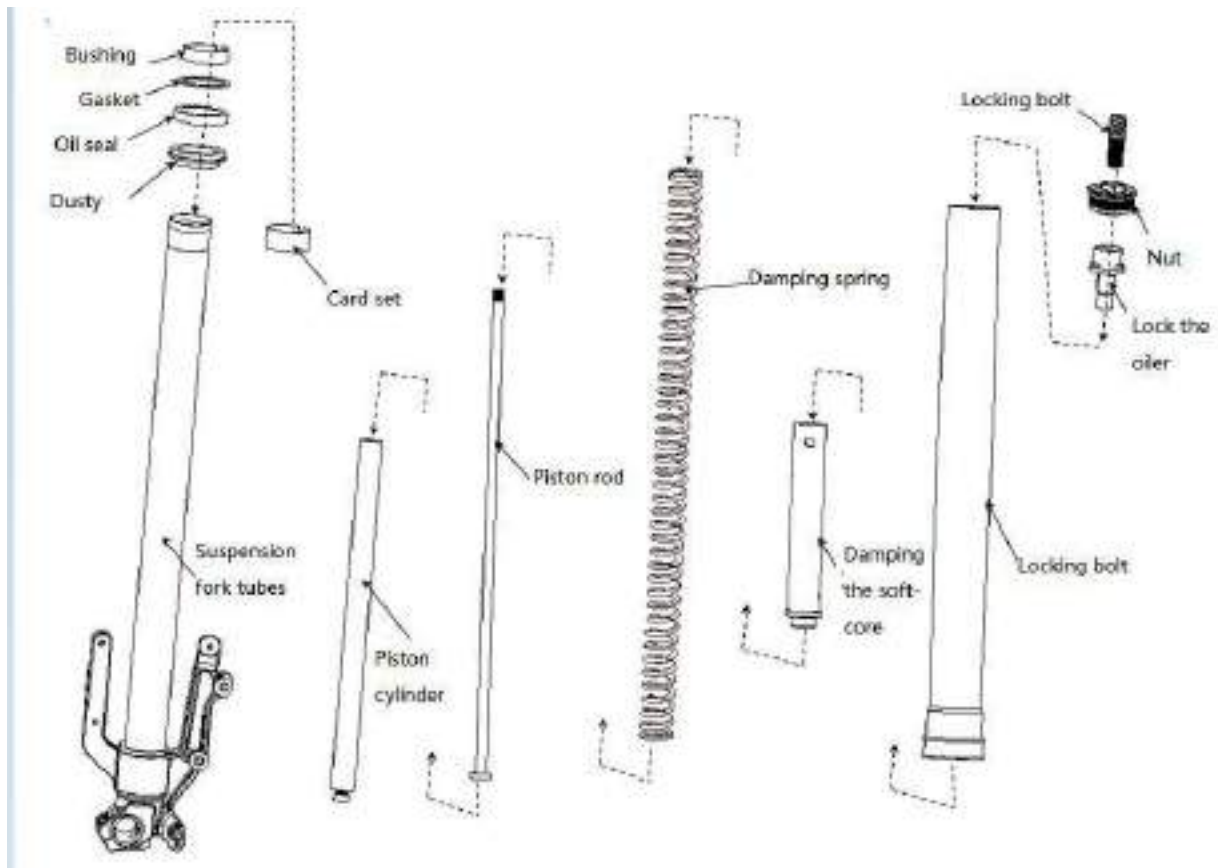

 FRONT WHEEL/SUSPENSION/STEERING

NOTICE:

Pour the specified amount of recommended fork fluid into the fork tube. Recommended shock absorption fluid: Professional suspension SS-8 (1W)

FORK FLUID CAPACITY: City edition: each $390\pm 3\text{ml}$; STR: left $525\pm 2\text{ml}$, right $455\pm 2\text{ml}$; SCR: $440\pm 2\text{ml}$ each, slowly pump the fork tube several times to clear the trapped air under the fork tube. Fully compress the fork tube and measure the level from the top of the fork tube

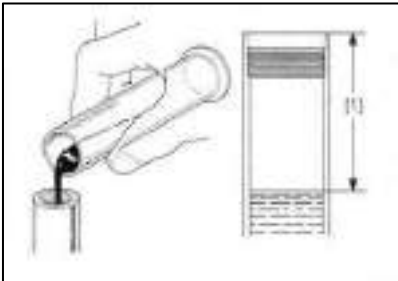
**REMOVAL**

Remove the following components:

- Connecting board line hook [1]
- Ignition lock [2]
- 4 bolts [3]
- Direction handle clamp [4]

Remove the cable harness clamp bolts of the lower connecting plate [1] Remove the clamping bolts of the upper connecting plate [2] loosen the direction post bolts [3]. Remove the upper connecting plate [4] and remove the shock absorption.



STEERING STEM

REMOVAL

Remove the following:

- Direction column[1]
- Upper inner ring[2]
- Upper steering bearing[3]
- Lower steering bearing [4]

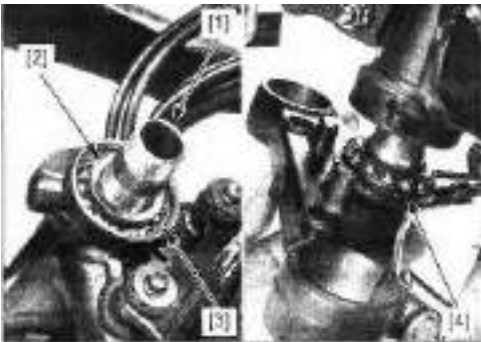

Install the rod nut on the steering column [1] to prevent damage to the thread when removing the lower bearing [2] of the steering column. Remove the bearing with a chisel or equivalent tool, being careful not to damage the steering column. Remove the lower dust seal [3]

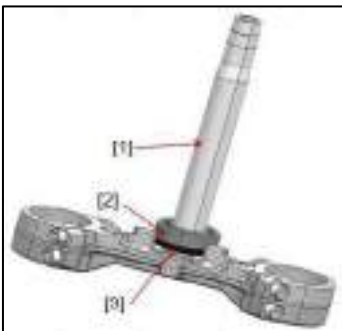

Install the new lower dust seal on the steering column [1] and press down the new lower bearing [2] of the steering column.

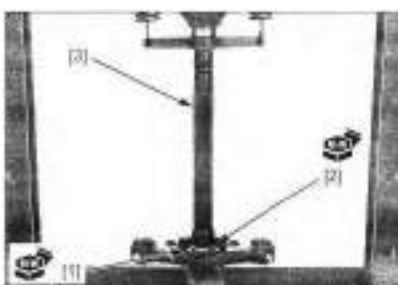

INSTALLATION

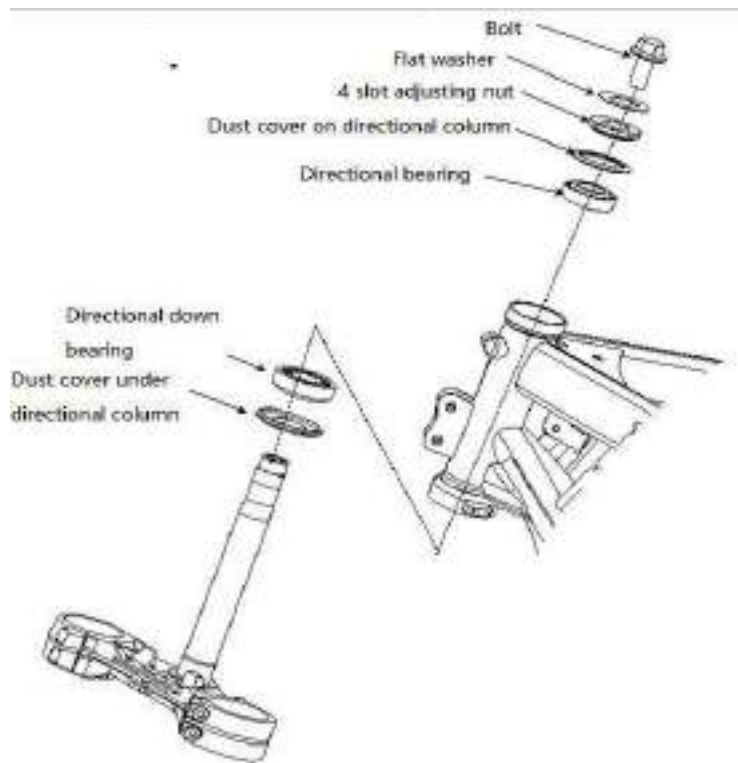

NOTICE:

Use urea-based multi-purpose extreme pressure grease NLGI#2 (Stamina EP2 or equivalent produced by Shell) for the bearing race surface and dust seal. Apply grease to the lip of the lower dust seal [1]. Apply 3-5 g (0.1-0.2 oz) (per bearing) on the sliding surface of the bearing race. Apply grease to the lip of the new upper dust seal [2]. On the thread of the adjusting nut Apply engine oil [3]

Install the following components:

- Direction down bearing [4]
- Direction bearing [5]
- Flat washers[6]
- Direction column[7]
- Dust cover for steering column

FRONT WHEEL/SUSPENSION/STEERING

Clean the thread of the valve stem with degreasing agent. Install the upper connecting plate [1], washers [2] and direction studs [3] to temporarily install the shock absorber to the bottom and top of the lower connecting plate, by tightening the clamping bolts of the lower connecting plate. Connection. Tighten the steering column nut to the specified torque

Torque: 80N.m(8kgf.m,59lbf.ft)

Ensure that there is no gap, cross movement, card issuance, etc. in the steering

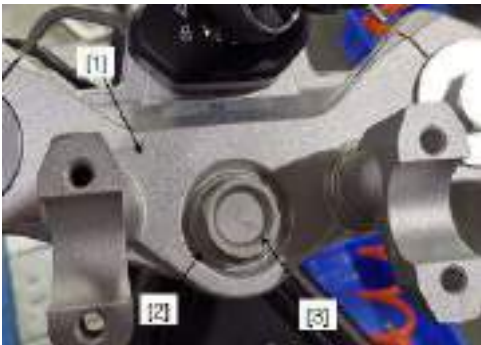

Install the handle tube and tighten the clamp bolt on the handle tube

Torque: 22N.m(2.2kgf.m,16 lbf.ft)

Hang the cable into the upper connecting board wire hook and tighten the lower connecting board wire clamp screws



17.REAR WHEEL/SUSPENSION

SERVICE INFORMATION ----- 17-1

REAR FORK ----- 17-7

TROUBLESHOOTING ----- 17-3

SHOCK ABSORBER/SUSPENSION ----- 17-9

REAR WHEEL ----- 17-4

SERVICE INFORMATION

GENERAL

When repairing the rear wheel and suspension, you need to support the motorcycle with a crane or equivalent. Contaminated Brake discs or Brake discs will reduce the Brake power. Discard the contaminated Brake discs and clean the contaminated Brake discs with a high-quality Brake degreaser .Do not operate the Brake pedal after removing the rear wheel. After installing the rear wheel, step on the Brake pedal to check the Brake operation. After the rear wheel is installed, perform an air gap check. All suspension pivots and suspension points can only use original Excelle bolts and nuts replace. Brake system repair.

TROUBLESHOOTING

Steers to one side or does not track straight.

- Drive chain adjusters not adjusted equally
- Bent axle
- Damaged frame
- Worn swingarm pivot components

Rear wheel wobbles

- Bent rim
- Faulty tire
- Worn or damaged wheel bearings
- Worn or damaged driven flange bearing
- Axle not tightened properly
- Faulty swingarm pivot bearings
- Suspension fasteners not tightened properly
- Unbalanced tire and wheel

Wheel hard to turn

- Faulty wheel bearings
- Bent axle
- Faulty driven flange bearing
- Drive chain too tight
- Brake drag

Soft suspension

- Low tire pressure

REAR WHEEL/SUSPENSION

- Incorrect suspension adjustment
- Weak shock absorber spring
- Oil leakage from damper unit

Stiff suspension

- High tire pressure
- Incorrect suspension adjustment
- Bent shock absorber damper rod
- Damaged suspension or swingarm pivot bearings
- Improperly tightened swingarm pivot

Rear suspension noise

- Loose suspension fasteners
- Worn or damaged suspension pivot bearings
- Faulty shock absorber

REAR WHEEL

REMOVAL/INSTALLATION

Remove the following:

- 2 bolts [1]
- rear wheel speed sensor [2]

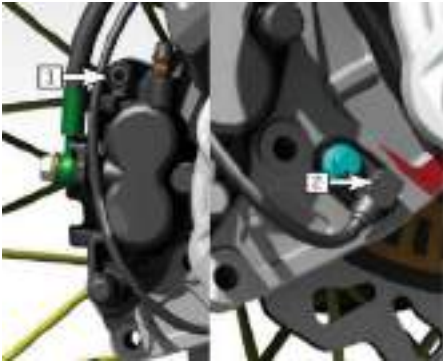

Loosen the rear axle lock nut [1]. Support the motorcycle with a crane or equivalent, and lift the rear wheel off the ground. Loosen the chain adjuster by turning the lock nut [2] and adjusting bolt [3] to make the wheel move forward. Push the rear wheel forward to make the chain free from the big sprocket [4].

Remove the following:

- rear axle nut
- the rear wheel
- rear brake clamp [5]
- chain regulator [6]

NOTICE:

Do not operate the Brake pedal after disassembling the wheel. Support the Brake pliers so that it will not hang on the Brake hose. Do not twist the Brake hose

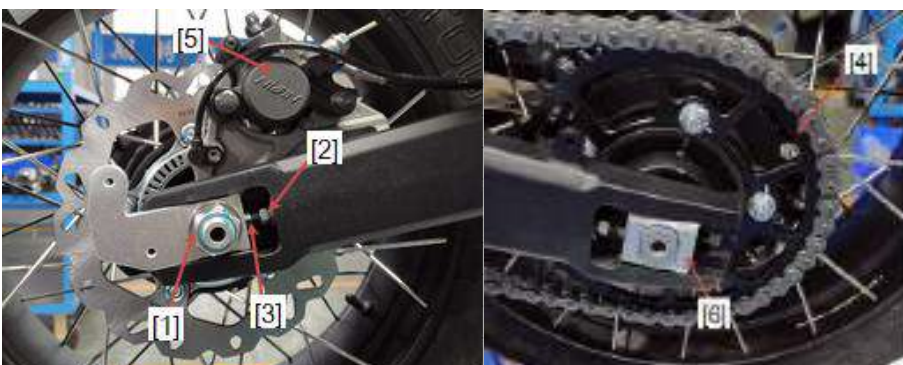

 REAR WHEEL/SUSPENSION

Disassemble the following parts:

Left flange (flange)[1]

Right side collar[2]

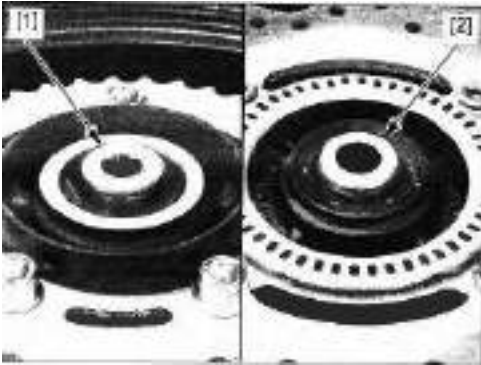

Installation and removal order is reverse

NOTICE:

When installing the wheel, NOTICE do not let the Brake pliers fall off from the rear flat fork boss, and do not damage the Brake piece. Install the shaft from the left. Before installing the rear wheel speed sensor [1], wipe the sensor tip and the installation area to remove any foreign objects. Adjust Drive chain slack. Check the gap between the wheel speed sensor and the ring gear



INSPECTION

Use your fingers to rotate the inner ring of each bearing. The bearing should rotate smoothly and quietly. Also check whether the outer ring of the bearing fits tightly with the hub. If the bearing does not rotate smoothly, rotates steadily, or is not firmly installed in the hub, replace the bearing. Check the following parts for damage, abnormal wear, deformation or bending.

-Rear flat fork

-Rim

- Tire rim
- Large sprocket
- Shock absorbing rubber

Measure each part according to the rear-wheel suspension specification. If the usage limit is exceeded, replace the part.

DISASSEMBLY/ASSEMBLY

Disassemble and assemble the rear wheel as shown in the following steps.

Wire clamp → rear wheel axle nut → rear wheel bushing → rear wheel

Installation and removal order is reversed

BEARING REPLACEMENT

WHEEL BEARING

Install the bearing remover head [1] into the bearing. From the other side of the wheel, install the bearing remover shaft [2] and push the bearing out of the hub.

Remove the spacer and knock out the other bearing and install it vertically into the new right bearing (Brake disc side) with the marked side facing up until it is fully seated.

Push the new left bearing in vertically, with the marked side facing up, until it is fully seated.

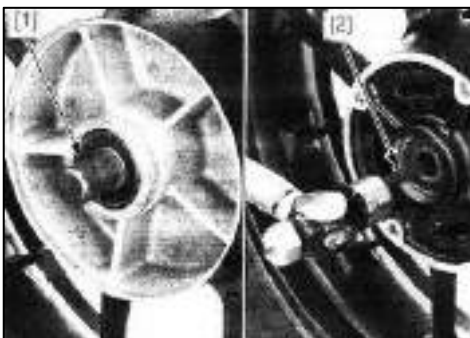

REAR FORK

REMOVAL/INSTALLATION

Disassemble the following parts: chain box [1], rear wheel small fender [2], muffler rear section [3], buffer related parts [4], chain [5], rear wheel [6], chain guard [7], sprocket guard [12], rear Brake oil pipe and speed sensor wire [8], U-shaped cradle [9], tripod [10], flat fork shaft decoration [11], installation sequence and removal Reverse order



NOTICE:

Install the rear fork shaft from the left. Spread butter on the fork shaft.

Torque:

Flat fork shaft nut: 88 N.m (8.8 kgf.m, 65 lbf.ft)

NOTICE: Support the Brake pliers so that it will not hang on the Brake hose and do not twist the Brake hose

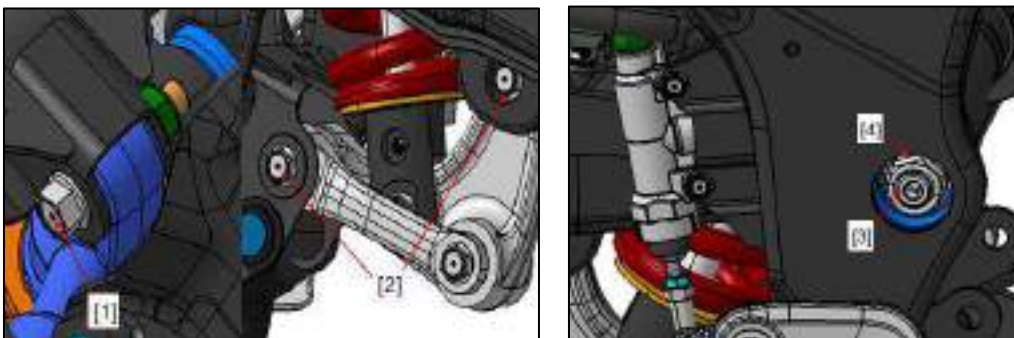

REAR WHEEL/SUSPENSION

REMOVAL/INSTALLATION

As shown in the figure below, the flat fork after disassembly and assembly

Install each dust seal so that the flat side faces outwards so that it is flush with the end face of the flat fork shaft.

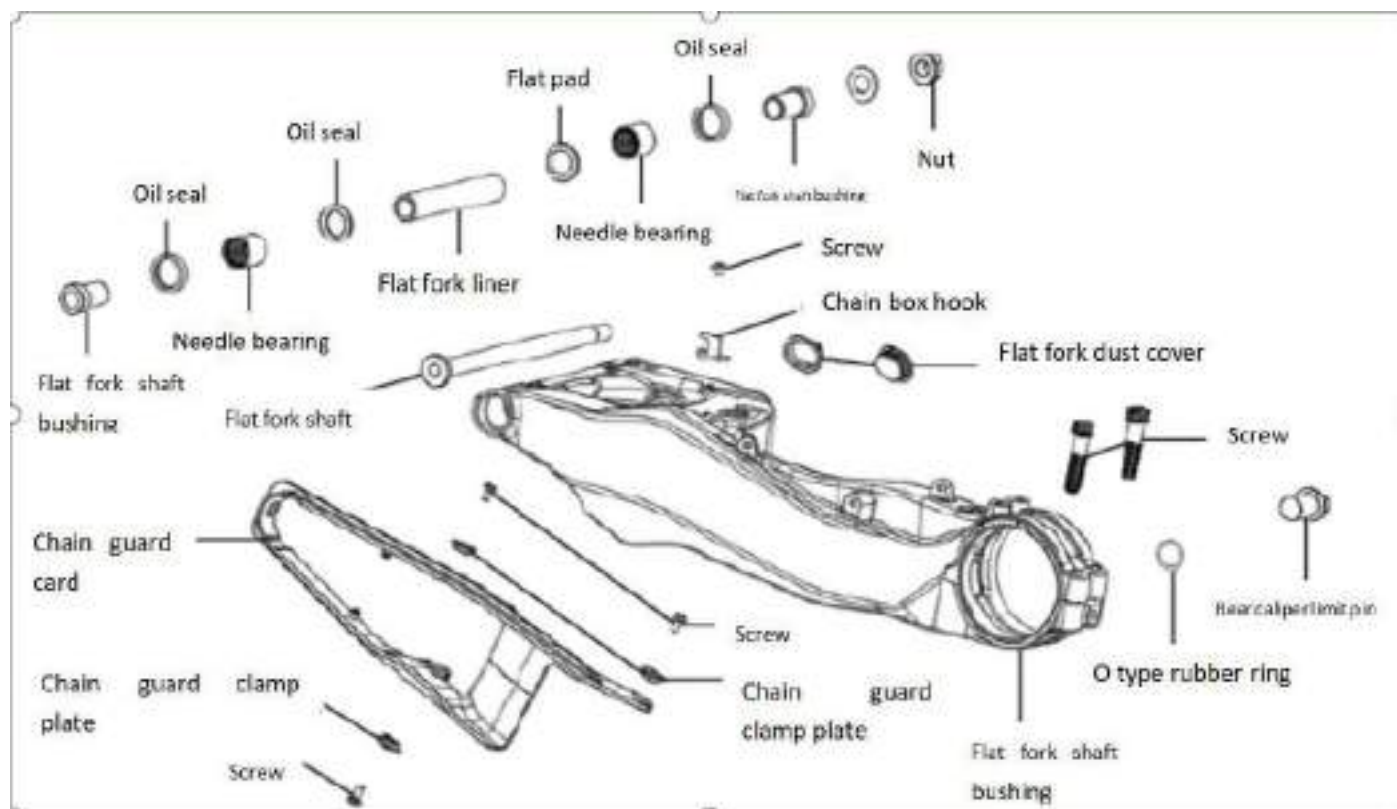

INSPECTION

Check whether the drive chain slider is worn or damaged. If the drive chain slider is worn to the wear limit indicator [1], it must be replaced. Check the following parts for damage, abnormal wear, and deformation.

- Rear flat fork
- bushing
- Bearing.

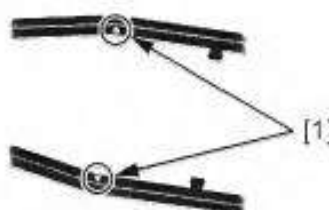

SHOCK ABSORBER/SUSPENSION

Shock absorber

Disassemble the following parts:

-Fuel tank guard plate-left

-Regulator/rectifier

-Start relay switch

Disconnect the wheel speed sensor 2P (black) connector [1] and remove it from the bracket.



REAR WHEEL/SUSPENSION

Disassemble the rear flat fork assembly, remove the shock absorber and cradle bolts [1]

The installation sequence is opposite to the removal sequence.

NOTICE:

Mounting bolts are installed from the left

Torque:

Shock absorber mounting bolts: 60N·m (6.0kgf·m, 44lbf·ft)



REMOVAL/INSTALLATION

CRADLE

Place the flat fork horizontally, and remove the flat fork and cradle mounting bolts [1] Remove the U-shaped cradle and tripod cradle mounting bolts [2]

Installation and removal order is reverse

Torque:

CRADLE Mounting bolt: 60N·m (6.0kgf·m, 44lbf·ft)



 REAR WHEEL/SUSPENSION

DISASSEMBLY/ASSEMBLY

Remove the bushing [1] and the dust seal [2]. Apply grease to the rotating area of the needle bearing. Apply grease to the new dust seal port. Install each dust seal so that its flat side faces outward , The end face is flush. Install the bushing.

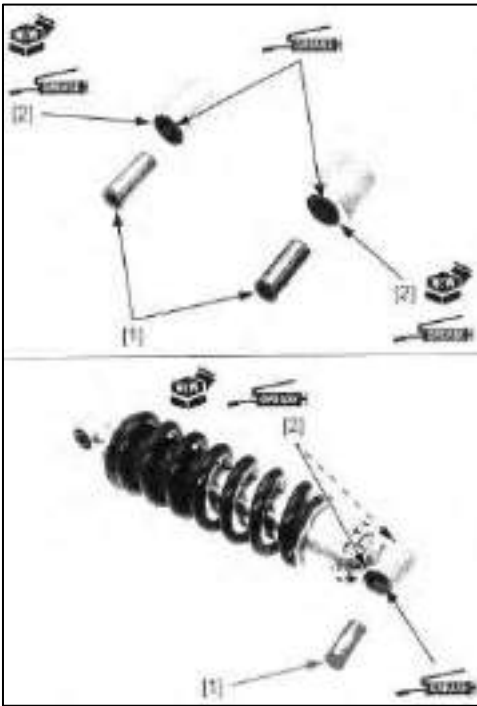

INSPECTION

Check the following parts of the shock-absorbing connecting rod for damage, abnormal wear, deformation or cracks.

- Shock absorber
- Shock absorbing connecting rod
- Sleeve
- Needle bearing

Check the following parts of the shock absorber for damage, abnormal wear, oil leakage or bending.

- Damping device
- bushing
- Needle bearing

18.HYDRAULIC BRAKE

SERVICE INFORMATION-----	18-1	FRONT BREAK PUMP -----	18-10
TROUBLESHOOTING -----	18-1	REAR BREAK PUMP -----	18-12
COMPONENT LOCATION-----	18-3	FRONT BRAKE CALIPER -----	18-14
BRAKE FLUID REPLACEMENT/			
EXHAUST -----	18-5	REAR BRAKE CALIPER -----	18-17
BRAKE PAD/DISC -----	18-8	BRAKE PEDAL -----	18-18

SERVICE INFORMATION

GENERAL



- Frequent inhalation of brake pad dust, regardless of material composition, could be hazardous to your health
- Avoid breathing dust particles
 - Never use an air hose or brush to clean brake assemblies. Use an OSHA-approved vacuum cleaner.

NOTICE:

Spilled brake fluid can seriously damage the instrument lens and paint surface, it is also harmful to some rubber parts; Be careful when removing the tank lid, first making sure the front tank is level.

This section describes the maintenance of the conventional braking components of the braking system. Used for anti-lock braking system maintenance

The ZF500X is equipped with ABS, but the brake fluid replacement procedure is performed in the same way as the normal vent procedure. Note that because the brake fluid is sealed in the regulator, there is no need to replace the brake fluid or exhaust the air from the brake fluid. Contaminated discs or discs can reduce braking power. Discard the contaminated brake discs and clean the contaminated discs with a quality brake degreaser.

When servicing the system, be sure to use fresh DOT 4 brake fluid from sealed containers. Do not mix different types of liquids. They may not be compatible. Do not allow contaminants (dirt, water, etc.) into open storage tanks. Once the hydraulic system is on, or if the brake feels soft, the system must be deflated and the braking operation must be checked. When removing the wheel speed sensor, check the clearance between the wheel speed sensor and the gear ring after installation.

TROUBLESHOOTING

BRAKE LEVER/PEDAL SOFT OR SPONGY

- Air in the hydraulic system
- Leakage of hydraulic system.
- Brake pads/discs are contaminated
- Brake caliper piston seal is worn
- The main plug bowl is worn
- Brake pads/discs are contaminated

- Brake caliper contamination
- The brake pump is contaminated
- Brake calipers slide abnormally
- Low brake fluid level
- Oil passage is blocked
- Brake disc distortion/deformation
- Brake caliper piston stuck/worn
- Main piston stuck/worn
- Brake lever/pedal bending

BRAKE LEVER/PEDAL REQUIRES FORCE

- Oil channel blocked/restricted
- Brake caliper piston stuck/worn
- Brake calipers slide abnormally
- Brake caliper piston seal is worn
- Main piston stuck/worn
- Brake lever/pedal bending

BRAKE RESISTANCE

- Brake pads/discs are contaminated.
- Wheel dislocation
- Brake discs/discs are severely worn
- Brake disc distortion/deformation
- Brake calipers slide abnormally
- Oil passage blocked/restricted
- Caliper piston stuck

COMPONENT LOCATION

Front Brake

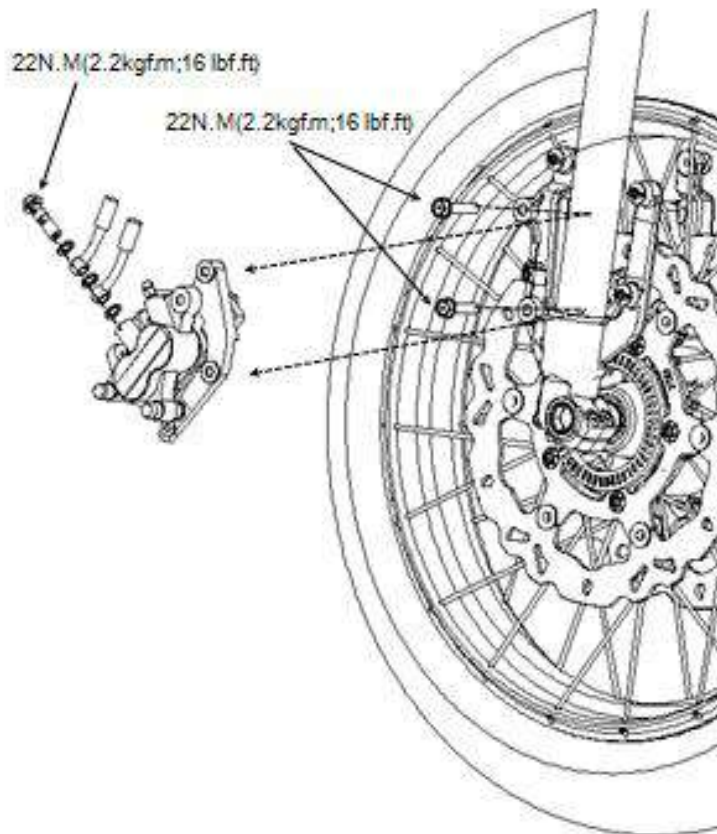
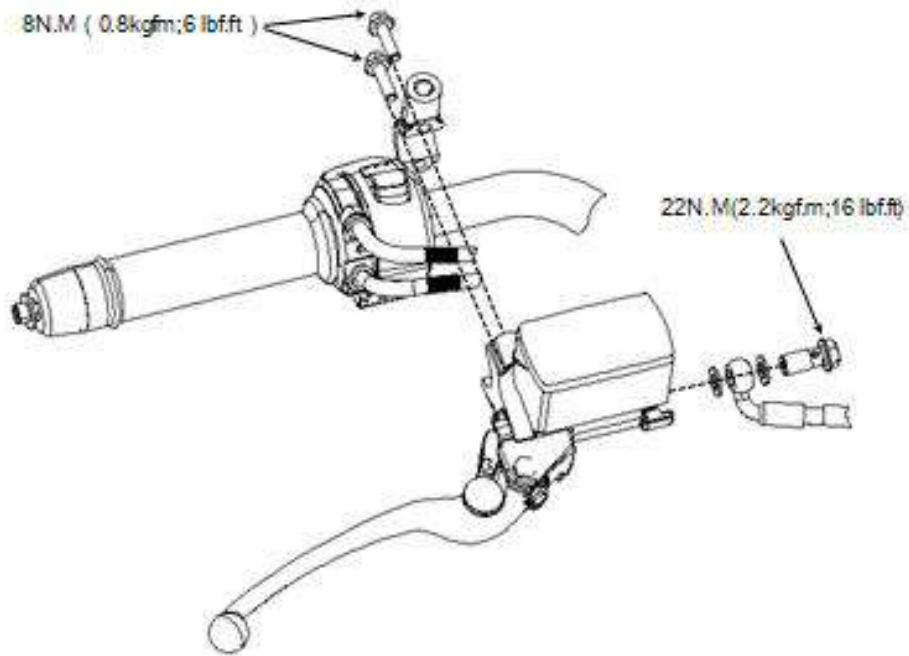

Rear Brake

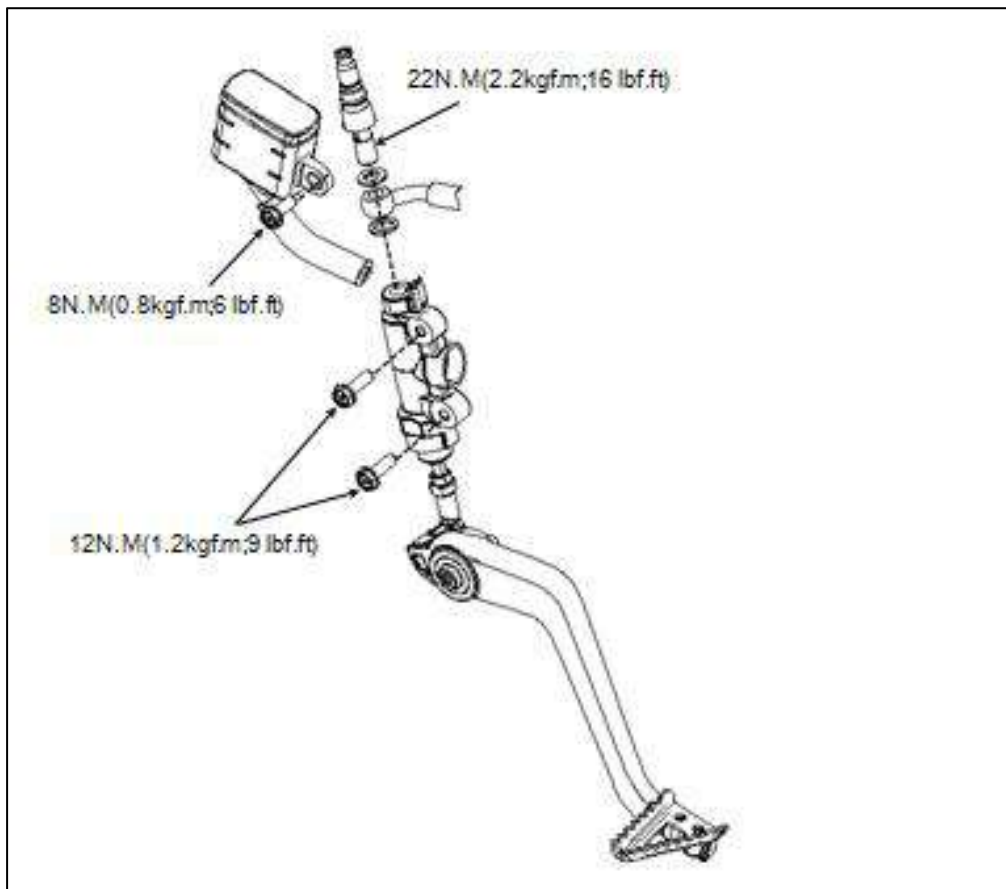

BRAKE FLUID REPLACEMENT/EXHAUST

BRAKE FLUID REPLACEMENT

Front brake

Turn the handle to keep the liquid tank level

Disassemble the following parts:

- 2 screws[1]
- Liquid tank cover[2]
- Fixed plate[3]
- Diaphragm [4]

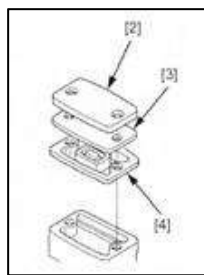

Rear Brake

Remove the mounting bolt [1] and the liquid tank [2] from the strut.

Disassemble the following parts:

*Be careful not to let
the liquid overflow
from the liquid tank*

- Two screws[3]
- Liquid storage cover[4]
- Fixed plate[5]
- Diaphragm [6]

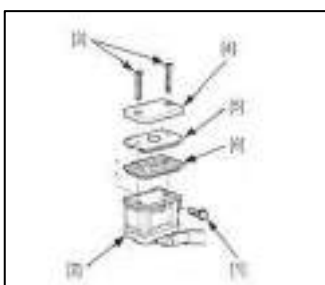

HYDRAULIC BRAKE

Connect the exhaust hose [1] to the Brake clamp exhaust valve [2]. Loosen the air valve and pump the Brake rod or pedal. Until no oil flows out of the exhaust valve. Close the exhaust valve.

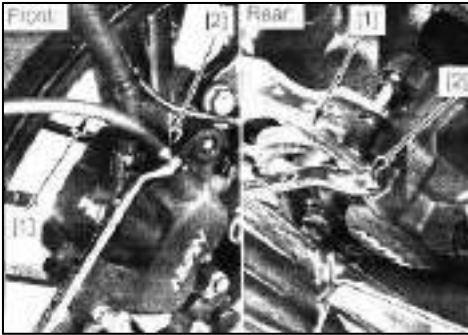

Always check the liquid level when exhausting to prevent air from being sucked into the system

BRAKE FLUID FILLING/EXHAUSTING

Use DOT 4 brake fluid in a sealed container to fill the reservoir into the upper pipeline [1]. Connect the commercial brake bleed valve to the bleed valve to operate the brake bleed valve and release the valve. If not Use an automatic refill system. Add oil when the liquid level in the reservoir is low. Perform a bleed procedure until the system is completely flushed/vented. Close the exhaust valve and operate the brake lever or pedal if you still feel sponge State, exhaust the system again.

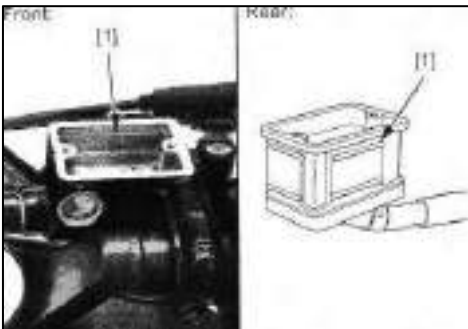

Do not release the brake lever or pedal before the exhaust valve is closed

If the brake exhaust valve is not available, use the following steps to connect the exhaust hose to the exhaust valve. Pump the system pressure with the brake lever/pedal until you feel the resistance of the brake lever/pedal

1. Squeeze the brake lever or keep pressing the brake pedal. Then release the exhaust valve 1/4 turn, wait a few seconds, and then close it.
2. Slowly release the brake lever/pedal and wait a few seconds after reaching the end of the stroke.
3. Repeat steps 1 and 2 until there are no air bubbles in the exhaust hose. After the system is completely exhausted, tighten the exhaust valve to the specified torque.

Torque: 5.4N.m(0.6kgf.m,4.0lbf.ft)

HYDRAULIC BRAKE

Front brake

Fill the reservoir to the upper level pipeline with DOT 4 brake fluid. Install the diaphragm, fixing plate, reservoir cap and tighten the screws to the specified torque.

Torque: 3N.m(0.3kgf.m,2.2 lbf.ft)

REAR BRAKE

By removing the screw [1] and the mounting bolt [4], carefully disassemble the liquid storage tank [3]. Install the liquid storage tank, align the bolts with the holes in the frame, and then tighten the mounting bolts.

Torque: 8N.m(0.8kgf.m;6 lbf.ft)

NOTICE: Do not let the liquid overflow from the liquid storage tank



BRAKE PAD/DISC

Brake PAD REMOVAL/INSTALLATIONNOTICE:

If you replace the new brake pads, before removing the brake pads, push the brake caliper inward to fully push the brake caliper piston in order to install the new brake pads. Be sure to replace the brake pads in pairs. Ensure that the brake disc pressure is even

Front Brake

Push the brake pad onto the brake pad spring, and then push the brake pad [2] out of the brake caliper to remove the pad pin [1].

NOTICE:

After removing the brake pads, do not operate the brake lever



Make sure that the spring washer [1] is installed in place. Make sure that the stop ring [2] on the piston pin is in good condition. If necessary, replace the stop ring with a new one. Apply silicone grease on the stop ring. Install the gasket [3] to make it The end is correctly installed in the retainer [4]. Push the brake pad onto the brake pad spring to align the brake pad and the brake pad pin hole in the brake caliper body, and install the brake pad pin [5]. Tighten the gasket pin to the specified torque.

Torque: 17N.m(1.7kgf.m,13 lbf.ft)

Operate the brake lever so that the brake caliper piston rests on the brake pads

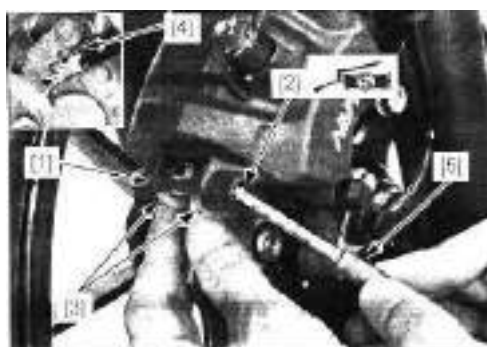

Rear Brake

REMOVAL/INSTALLATION

Disassemble the following parts:

- 2 bolts [1]
- Rear wheel speed sensor [2]

NOTICE:

After removing the Brake piece, do not operate the Brake lever

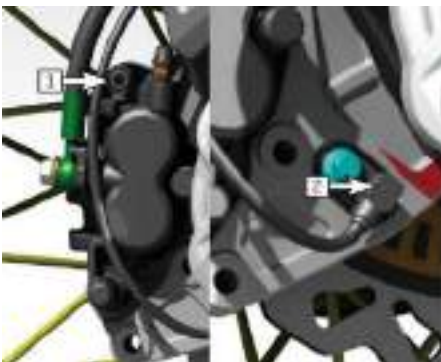

Make sure that the spring washer [1] is installed in place. Make sure that the stop ring [2] on the piston pin is in good condition. If necessary, replace the stop ring with a new one. Apply silicone grease on the stop ring. Install the gasket [3] to make it The end is properly fixed on the pad retainer [4]. Lower the brake caliper body and loosen the new brake caliper bolt [5]. Push the brake pad onto the brake pad spring to align the brake Pad and brake pad pin hole on the brake caliper body, install the brake pad pin [6]. Tighten the brake caliper bolt to the specified value

Torque: 22N.m(2.2kgf.m,16 lbf.ft)

Tighten the brake pad pin to the specified torque

Torque: 17N.m(1.7kgf.m,13 lbf.ft)

Operate the brake pedal to make the brake caliper piston close to the brake pad

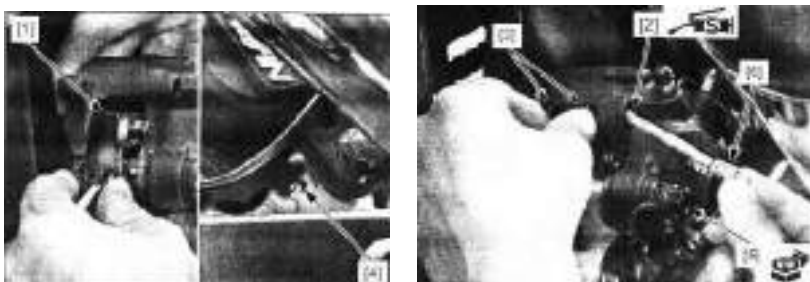

BRAKE DISC INSPECTION

Visually inspect the brake disc for damage or cracks. Measure the brake disc according to the hydraulic brake specification and replace it if necessary.

FRONT BRAKE PUMP

REMOVAL/INSTALLATION

Drain the brake fluid from the front brake hydraulic system.

Disassemble the following parts:

- Right rearview mirror
- Brake light switch connector [1]
- Oil bolt[2]
- Sealing washer[3]
- Brake hose[4]

Note: When removing the brake pipe locking bolt, cover the end of the brake hose to prevent contamination

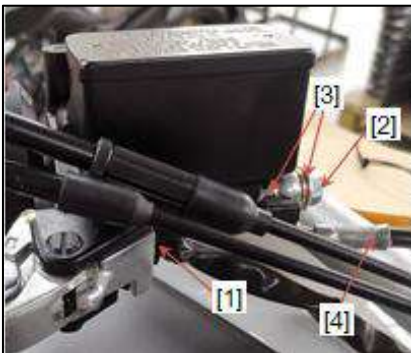

- 2 bolts[1]
- Brake handle holder[2]
- Brake pump[3]

The installation sequence is opposite to the removal sequence.

NOTICE:

Replace with a new gasket. Install the Brake handle holder so that the "UP" mark is facing upwards. · Align the edge of the master cylinder with the punch mark on the handlebar,

Tighten the upper bolt first, and then the lower bolt. When connecting the Brake hose, be sure to put the eyelet connector in the groove

Torque:

Brake handle holder: 8N.M (0.8kgf.m;6lbf.ft)

Brake tube locking bolt: 22N.M(2.2kgf.ft;16lbf.ft)

Front brake hydraulic system for filling and draining



REMOVAL/INSTALLATION

As shown in the figure below, before disassembling and assembling the Brake pump. Do not allow the piston cup to turn from the inside to the outside. Install the snap ring so that the chamfered edge faces the thrust load side, and make sure that the snap ring is firmly fixed in the groove. Do not reuse A snap ring that is easy to rotate in the groove. Correctly align the switch boss with the main cylinder hole. When tightening the pivot nut, firmly fix the pivot bolt

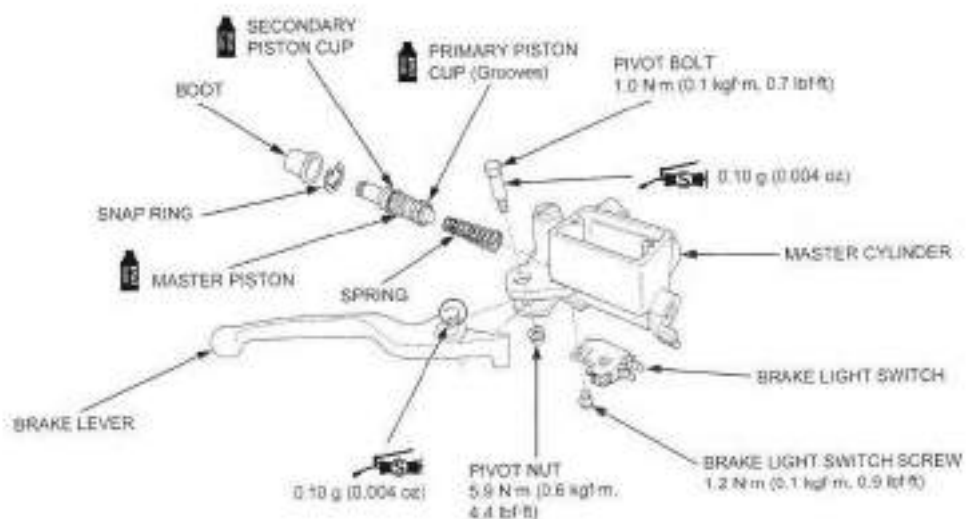

INSPECTION

Check the following parts for scratches, scratches, deterioration or damage.

- Brake pump
- Main piston
- Piston Cup
- spring
- Protection cover

Measure parts according to hydraulic brake specifications and replace if necessary.

REAR BRAKE PUMP

REMOVAL/INSTALLATION

Drain the brake fluid in the rear brake hydraulic system.

Disassemble the following parts:

- Rear brake pump bolt[1]
- Rear brake oil cup bolt[2]
- Rear brake switch[3]



Remove the following:

- Mounting bolt[1]
- Rear brake pump[2]

Install in the reverse order of disassembly. Note: When tightening the Brake tube locking bolts, make sure that the horizontal limit pin rests on the limiter

Torque:

Rear brake pump mounting bolt: 12 N.m (1.2 kgf.m, 9 lbf.ft)

Brake tube locking bolt: 22N.M (2.2kgf.ft; 16lbf.ft)



REMOVAL/INSTALLATION

Follow the steps below to disassemble and assemble the master cylinder. When installing the push rod joint, adjust the length of the push rod between the center of the mounting bolt hole and the center of the connecting pin hole so that the piston cup mouth does not rotate from the inside to the outside. When installing the snap ring, The beveled side faces the thrust load side, and make sure that the snap ring is firmly fixed in the groove. Do not reuse the snap ring that is easy to rotate in the groove.

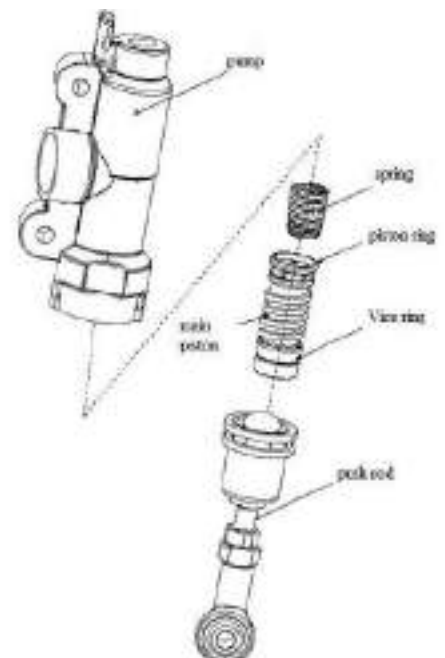

HYDRAULIC BRAKE

After removing the push rod, adjust the length of the push rod so that the distance from the center of the mounting bolt hole under the master cylinder to the center of the connecting pin hole is the standard length. If the length is adjusted to a longer position as shown in the figure, make sure that the thread of the push rod is [1] The lower end is visible in the joint. After adjustment, tighten the connecting nut [2] to the specified torque.

Torque:

Rear total pump push rod joint nut: 17 N.m (1.7 kgf.m, 13 lbf.ft)

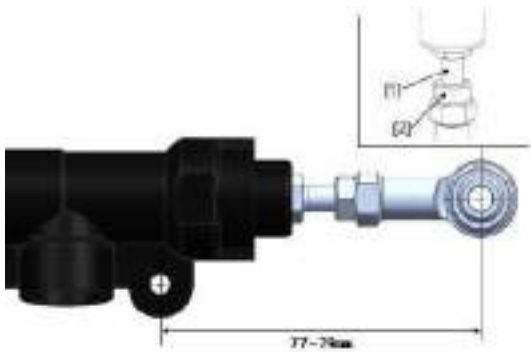

INSPECTION

Check the following parts for scoring, scratches, deterioration or damage.

- master cylinder
- master piston
- piston cups
- spring
- boot

Measure parts according to hydraulic brake specifications and replace if necessary.

FRONT BRAKE CALIPER

REMOVAL/INSTALLATION

Drain the brake fluid from the front brake hydraulic system.

Remove the following:

- bolt [1] and wire clamp[2]



- two bolts [3] and front wheel speed sensor[4]
- Brake pads[1]
- Brake tube locking bolt [2]
- Sealing washer[3]
- Brake hose[4]
- Mounting bolt[5]
- Brake pliers[6]

The installation sequence is opposite to the removal sequence.

NOTICE:

Replace the brake caliper mounting bolts and sealing washers. When tightening the brake pipe locking bolts, be sure to rest the eyelet stopper against the brake caliper body.

Before installing the wheel speed sensor, wipe the tip of the sensor and the installation area to remove any foreign objects.

Torque:

Front brake caliper mounting bolt: 22N.M(2.2kgf.ft;16lbf.ft)

Brake pipe locking bolt: 22N.M(2.2kgf.ft;16lbf.ft)

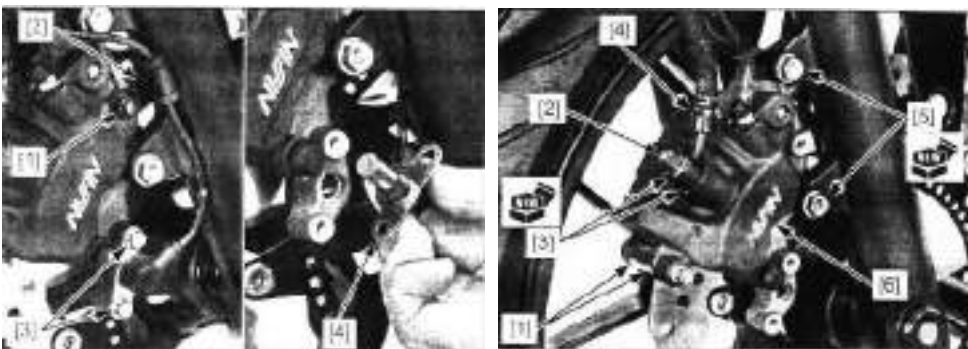

HYDRAULIC BRAKE

DISASSEMBLY/ASSEMBLY

As shown in the figure below, disassemble and assemble the front brake caliper. It is used to remove/install the brake pads. Mark the piston and make sure to reinstall it to its original position. When removing the brake caliper piston with compressed air, please place it on the piston. Put a rag to prevent damage to the piston and caliper body; do not use high pressure or put the nozzle close to the fluid inlet. Install the piston so that the opening faces the gasket.

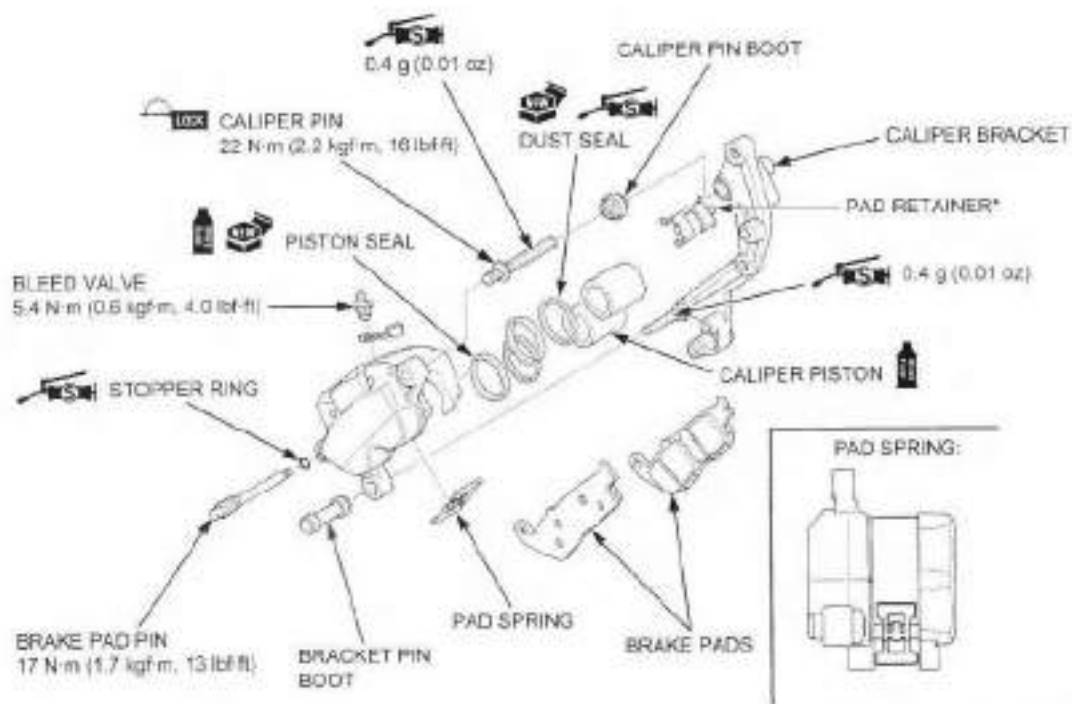

INSPECTION

Check the following parts for scratches, scratches, deterioration or damage.

- Brake caliper cylinder
- Brake caliper piston

Measure parts according to hydraulic brake specifications and replace if necessary.

REAR BRAKE CALIPER

REMOVAL/INSTALLATION

Drain the brake oil in the rear brake hydraulic system.

- Brake pipe locking bolt[1]
- Sealing washer[2]
- Brake hose[3]
- Brake pads
- Brake caliper[4]
- Brake caliper pin sleeve[5]

The installation sequence is opposite to the removal sequence.

NOTICE:

Replace with new gaskets and sealing gaskets. If the gasket retainer [6] has been removed, apply adhesive to the surface of the retainer. Apply 0.4 g (0.01 oz) of silicone grease to the sliding area of the brake caliper pin bolt. Tighten the brake When the tube lock bolts, be sure to rest the eyelet stop pin against the calibration body.

Torque: Brake pipe locking bolt: 22N.M(2.2kgf.ft;16lbf.ft)

Fill and bleed the rear brake hydraulic system.

Disassemble the following parts:

- Brake switch[1]
- Return tension spring[2]
- Bolt[3]
- Brake pedal[4]

The installation sequence is opposite to the removal sequence.

NOTICE:

Apply grease to the sliding area (lubrication groove) of the pedal pivot. Install each spring in the direction shown

Torque:

Brake pedal mounting bolt: 22N.M(2.2kgf.ft;16lbf.ft)



19.ANTI-LOCK BRAKE SYSTEM (ABS)

SERVICE INFORMATION	19-1	ABS INDICATOR CIRCUIT TROUBLESHOOTIN ---	19-9
SYSTEM LOCATION.....	19-2	WHEEL SPEED SENSOR	19-13
SYSTEM DIAGRAM.....	19-3	ABS MODULATOR	19-15
ABS TROUBLESHOOTING			
INFORMATION	19-4		

ANTI-LOCK BRAKE SYSTEM (ABS)

SERVICE INFORMATION**GENERAL****NOTICE:**

If it falls, it may damage the ABS regulator. In addition, if the connector is disconnected when the current is flowing, the excessive voltage may damage the control unit. Be sure to turn off the ignition switch before repairing. The overflowing brake fluid will seriously damage the plastic parts and Painted surface. It is also harmful to some rubber parts. This section introduces the maintenance of the anti-lock braking system (ABS). For other maintenance of the braking system (conventional braking), please refer to the hydraulic brake section. ABS control unit Integrated in the regulator. Do not disassemble the ABS regulator. When the ABS regulator fails, replace it with the ABS assembly. The ABS control unit performs pre-start self-diagnosis to check whether the ABS is working properly until the vehicle speed reaches 10 kilometers. /Hour (6 miles/hour). After the pre-start self-diagnosis, the ABS control unit continuously monitors the ABS function and vehicle operating conditions until the ignition switch is turned off (normal self-diagnosis). When the ABS control unit detects a malfunction, it will stop ABS function and switch back to normal braking operation, and the ABS indicator flashes or keeps on. Be careful when you test drive, carefully read the "ABS troubleshooting information", check and eliminate the ABS system failure according to the troubleshooting flowchart. Follow the procedures one by one Before starting the diagnosis and troubleshooting, write down the diagnostic trouble code and possible fault location, and use a fully charged battery. Do not use the charger connected to the battery for diagnosis. After troubleshooting, clear the diagnostic trouble code (DTC), and perform pre-start self-diagnosis to ensure that the ABS indicator is working correctly. The ABS diagnostic system cannot identify the fault that is not caused by the faulty ABS (such as squeaking of the brake discs, uneven wear of the brake pads). Change the wheel speed When the sensor and/or the gear ring, be sure to check the air gap

The following color codes are used in this section.

Bl=black	G=green	Lg=light green	R=red	Y=yellow
Br=brown	Gr=grey	O=orange	V=purple	
Bu=blue	Lb=light blue	P=pink	W=white	

ANTI-LOCK BRAKE SYSTEM (ABS)

SYSTEM LOCATION



ANTI-LOCK BRAKE SYSTEM (ABS)

SYSTEM DIAGRAM

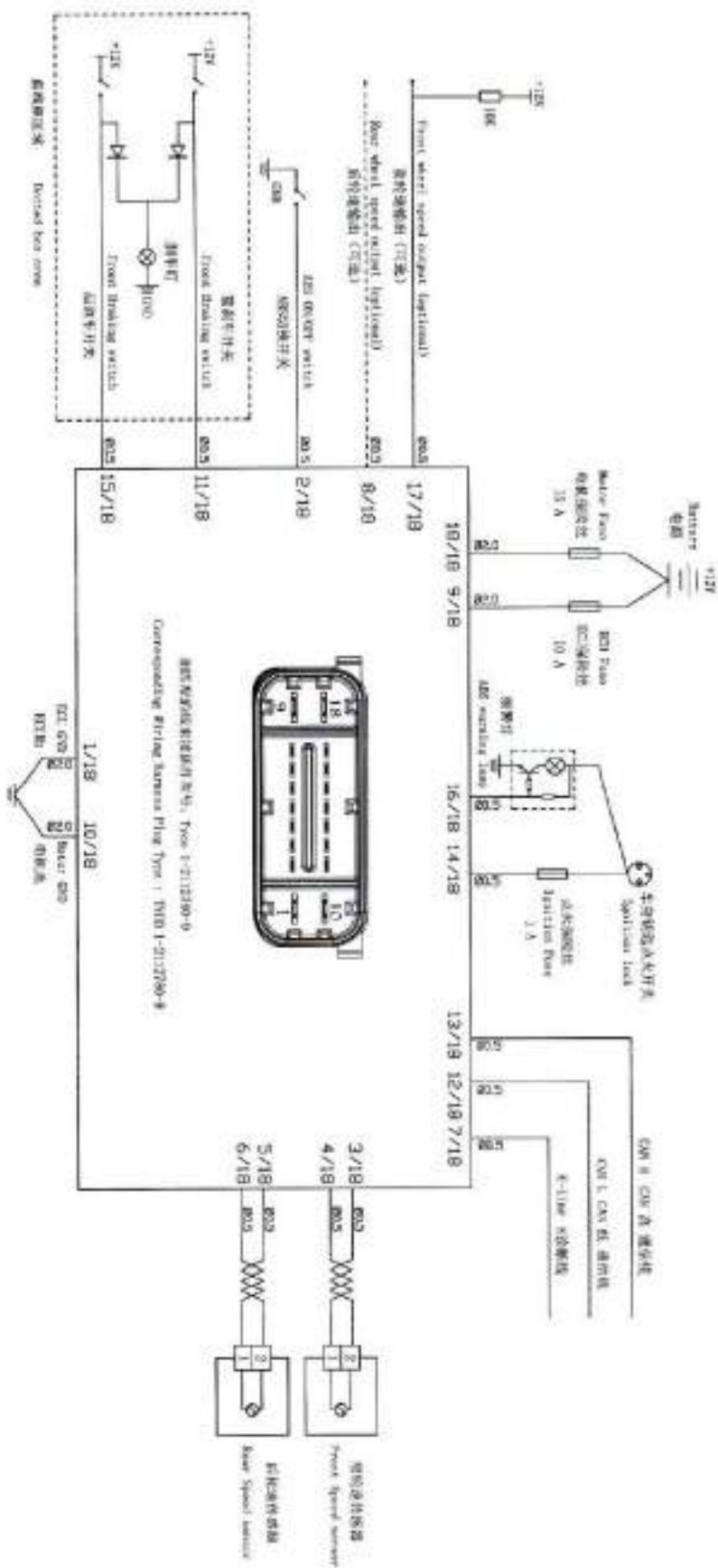

ANTI-LOCK BRAKE SYSTEM (ABS)

ABS TROUBLESHOOTING INFORMATION

SYSTEM DESCRIPTION

Composition of ABS

The ABS unit is composed of a hydraulic control unit (HCU), an electronic control unit (ECU) and a motor. It is installed in the frame. A wheel speed sensor is installed on the front and rear wheels.

ABS warning light

The function of the warning light: Shows whether the ABS is working normally. If the ABS fails, the warning light will light up to warn the driver. When the speed difference between the front wheel and the rear wheel is extremely large under extreme driving conditions, such as when performing front wheel off When the ground balance stunt or the rear wheel slips, the ABS may fail if you ride normally again. In order to ensure the ABS function is normal, you need to stop and turn off the ignition switch. If you restart the vehicle and the speed reaches 12km/h, the warning light will automatically go out and ABS Will be re-enabled.

After turning on the ignition switch, the ABS warning light is on. When the first riding speed is greater than 5km, it will report after passing the self-check.

The warning light goes out, and then in the same ignition cycle, if there is no abnormality, the warning light remains off. If the ABS is always on during driving ($\geq 5\text{km/h}$), it means that there is a fault in the ABS. At this time, the ABS cannot be activated. Function failure. The brake system itself still works, but the ABS regulation system fails.

ABS status switch

State switch: Disable or turn on the ABS function. To switch the ABS state, please make sure that the motorcycle is always powered on; this is only possible when the vehicle speed is lower than a certain value. It is recommended to switch the state when the vehicle is stationary.

The ABS modes are: ABS fully open, individually closed rear wheels, ABS fully closed. The ABS mode can be selected through the button on the instrument. Whether the ABS function is turned on or off, power is turned off and on again, the ABS will automatically turn on.

Troubleshooting-diagnostic instrument

Fault diagnosis needs to be tested in the parking state. Maintenance personnel can connect the OBD interface through the diagnostic tool to read the information of ABS. The operating interface of the diagnostic tool is as follows:

ANTI-LOCK BRAKE SYSTEM (ABS)

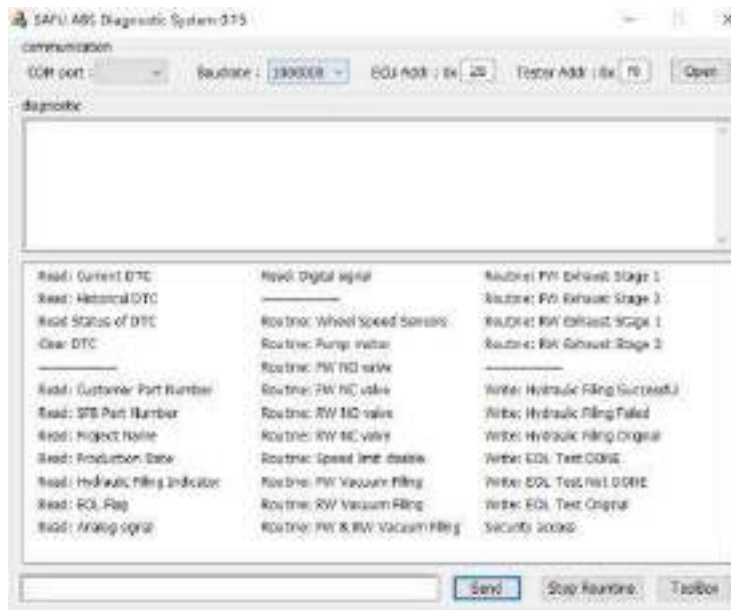

The diagnosis interface can display the current fault code (DTC) of the ABS. For the list of DTC faults, please see the appendix. 1. If the DTC still exists after multiple diagnosis, please follow Table 2 to deal with the fault.

K wire short grounding diagnosis

It is not necessary to use the diagnostic instrument, but use the K-line grounding to quickly diagnose the fault, as follows:

1) When the ABS has no DTC, the K wire is grounded or there is no response to grounding for a long time; ABS has the current DTC, and the K wire is grounded

If it is greater than or equal to 5s, the warning light starts to display all current DTCs in sequence (take the last 3 digits of the code).

2) The display time of the number 0 is 1000ms, that is, the alarm light is off for 1000ms; the non-zero number flashes at a frequency of 300ms,

The number of flashes is the size of the number. For example, the number 3 flashes 3 times at a frequency of 300ms.

3) The digital interval of the same DTC is 1s (the warning light is always on during the period); the time interval between DTCs is 3s (the period

The warning light is always on);

4) ABS has current DTC, and the K wire is grounded for more than or equal to 5s after releasing it, the warning light will display all current DTC once;

After the K line is grounded, do not release it, and the alarm lamp will display all current DTCs in a loop.

for example :

1) Diagnose a DTC "C0083":

K wire grounding is greater than or equal to 5s, loosen and control mechanism of alarm lamp end is shown in the schematic diagram below.

ANTI-LOCK BRAKE SYSTEM (ABS)

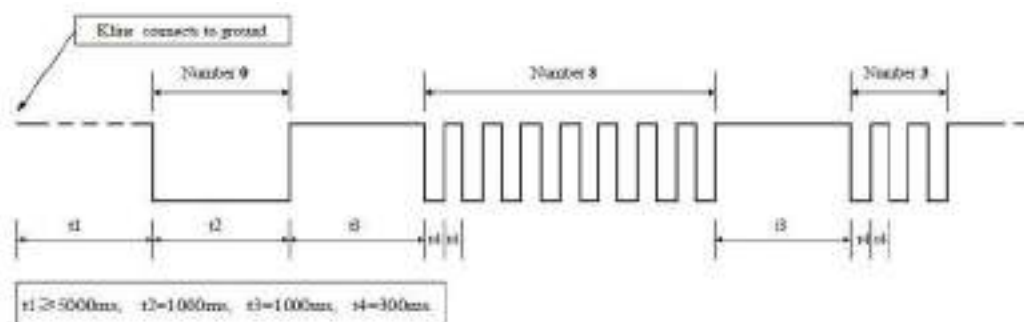

2) Diagnose 2 DTC “C0083” 、 “C0213” :

K wire grounding is greater than or equal to 5s, loosen and control mechanism of alarm lamp end is shown in the schematic diagram below.

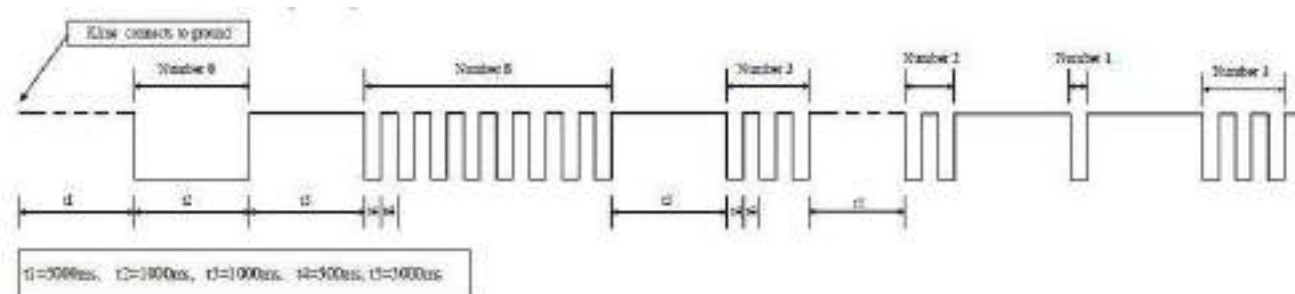

Table 2 Failure treatment measures

故障类型(failure type)	DTC	采取措施(Handling)
微控制器故障 (MCU Failure)	C0024~C0041	ABS 故障 ，请咨询供应商后，更换新 ABS ABS failure, please replace new ABS after consulting supplier.
固态继电器故障 (Solid State Relay Failure)	C0044~C0046	ABS 故障 ，请咨询供应商后，更换新 ABS ABS failure, please replace new ABS after consulting supplier.
电池电压故障 (The battery voltage Failure)	C0051~C0052	主要是外围电路故障! Mainly peripheral circuit failure! 检查车辆供电系统(线束连接、保险丝、电瓶、整流器) Check the vehicle power supply system(The fuse, battery, rectifier)
刹车信号故障 (The brake signal failure)	C0060~C0062	主要是外围电路故障! Mainly peripheral circuit failure!

ANTI-LOCK BRAKE SYSTEM (ABS)

		<p>1.检查刹车二极管是否损坏; Check the brake diode</p> <p>2.检查刹车信号线和 ABS 连接情况。 Check the connection between brake line and ABS</p>
电机故障(Pump motor fault)	C0070、C0071	<p>主要是外围电路故障! Mainly peripheral circuit failure!</p> <p>检查电机供电线 Check the motor power supply line</p>
电机故障(Pump motor fault)	C0072~C0075	<p>ABS 故障, 请咨询供应商后, 更换新 ABS ABS failure, please replace new ABS after consulting supplier.</p>
轮速传感器接线故障 (Wheel speed sensor wiring fault)	C0080~C0083 C0100~C0103	<p>主要是外围电路故障! Mainly peripheral circuit failure!</p> <p>1.检查传感器线束与 ABS 连接通断情况, 若问题未解决, 进行下一步; Check the connection between sensor wire and ABS</p> <p>2.尝试更换轮速传感器。 Try to change the wheel speed sensor.</p>
轮速信号质量故障 (Wheel speed signal quality failure)	C0084~C0088 C0104~C0108	<p>主要是外围故障! Mainly peripheral failure!</p> <p>1.检查前后轮速传感器安装是否规范(传感器头部与齿圈的距离 $\leq 1.5\text{mm}$); Check the installation of wheel speed sensor(The gap between sensor head and the tone wheel is 1.5 mm or less)</p> <p>2.检查齿圈是否有变形以或损坏。 Check if there is a deformation , or a damage with the tone wheel</p>
线圈故障 (coil failure)	C0120~C0171	<p>ABS 故障, 请咨询供应商后, 更换新 ABS ABS failure, please replace new ABS after consulting supplier.</p>
报警灯输出故障 (warning lamp output failure)	C0210、C0213	<p>主要是外围电路故障! Mainly peripheral circuit failure!</p> <p>检查仪表盘与 ABS 连接处线束, 若问题未解决, 请更换仪表, 若问题仍未解决, 请咨询供应商 Check the connection between dash board and ABS, if the problem not solved, please change the dash board. If the problem remains unresolved, please consult the supplier.</p>
轮速输出口故障 (WSS output failure)	C0230、C0231	<p>主要是外围电路故障! Mainly peripheral circuit failure!</p> <p>检查外围电路和仪表, 若问题未解决, 请咨询供应商后, 更换新 ABS Check the circuit and dash board, if the problem not solved, please replace new ABS after consulting supplier.</p>

NOTICE: C0060, C0061 and C0062 will not fail if the software is configured with no brake signals.

ANTI-LOCK BRAKE SYSTEM (ABS)

CIRCUIT INSPECTION**INSPECTION AT ABS MODULATOR CONNECTOR**

Remove the ABS regulator cover. Turn off the ignition switch.

Disconnect procedure: Turn the lock lever [1] to this side, and at the same time press the lock plate [2] to release it. Make sure that the lock lever turns all the time and disconnect the ABS adjuster 18P (black) connector [3]

Connection procedure:

Make sure that the lock lever is completely against the wire side of the connector. In the area shown in the figure, (as shown by the arrow), press and connect the 18P (black) connector of the ABS adjuster until the lock tongue clicks. Make sure the connector is secure locking.

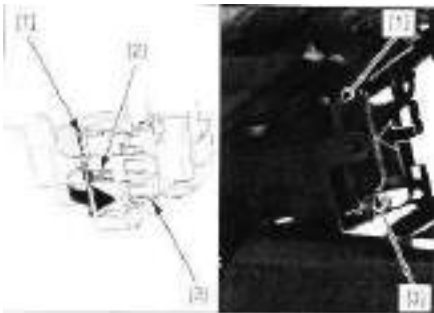

Before disconnecting the connector, be sure to clean the surroundings and stay away from foreign objects on the connector. ABS failure is usually related to poor connection or connection corrosion. Before continuing, please check these connections. In the ABS regulator 18P (black) connector terminal (harness side, (Except for terminals 9 and 18) When testing, be sure to use the test probe [1]. Insert the test probe into the connector terminal, and then connect the digital multimeter probe to the test probe.

 ANTI-LOCK BRAKE SYSTEM (ABS)

ABS INDICATOR CIRCUIT TROUBLESHOOTIN
ABS INDICATOR DOES NOT COME ON (when the ignition switch turned ON)
NOTE:

- Check the initial operation of the combination meter before starting the inspection.

1. Indicator Operation Inspection

Turn the ignition switch OFF.

Disconnect the ABS modulator 18P (Black) connector .

Turn the ignition switch ON with the engine stop switch “” .

Check the ABS indicator.

Does the ABS indicator come on?

YES – Faulty ABS modulator

NO – GO TO STEP 2

2.Indicator Signal Line Short Circuit Inspection

Turn off the ignition switch, and check the continuity between the 18P (black) connector [1] terminal of the ABS regulator on the harness side and the ground

TOOL:

Multimeter

Connection: 16-ground

Is there continuity?

YES-purple white wire short circuit

NO-Combination meter failure

The ABS indicator light stays on (the indicator light does not go out when the motorcycle is running)

1. Overhaul and check the open circuit of the circuit

Turn off the ignition switch. Disconnect the 18P (black) connector of the ABS regulator. Check the continuity between the terminal [P16] of the 18P (black) connector of the ABS regulator on the harness side and the indicator signal of the instrument.

TOOL: Multimeter

ANTI-LOCK BRAKE SYSTEM (ABS)

Connection: 16-instrument signal line

Is there continuity?

YES-Go to step 2

-Combination meter failure

NO-Purple white wire is open

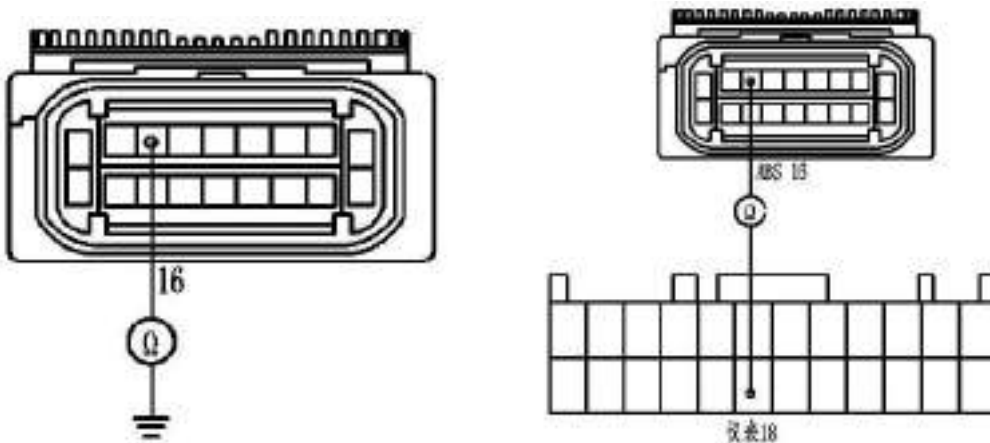

2. Check the modulator ground wire for open circuit

Turn off the ignition switch. Check the continuity between the 18P (black) connector [1] terminal of the ABS regulator on the harness side and the ground.

Connection: 1-ground/10-ground

Is there continuity?

YES-Go to step 3.

NO-Green wire is open

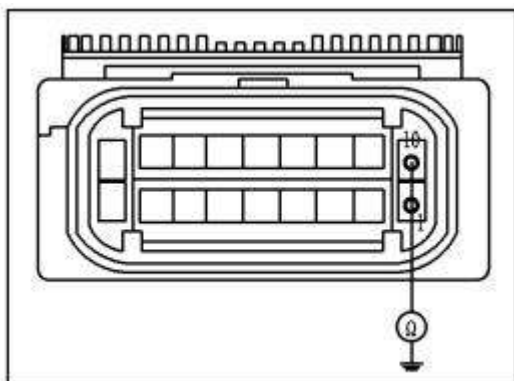

ANTI-LOCK BRAKE SYSTEM (ABS)

3. Fuse Inspection

Disassemble the following parts:

Loosen the two bosses of the seat and remove the fuse box cover from the fuse box 2 (right side). Check whether the ABS main fuse (15A/20A) is blown.

Is the fuse blown?

YES-Go to step 4.

NO-Go to step 5.

**4. Short circuit check of power input line**

With the ABS main fuse (15A/20A) removed, check the continuity between the 18P (black) connector of the ABS regulator on the harness side and the ground

Connection: 9-ground/18-ground

Is there continuity?

YES-yellow wire short circuit / black blue wire short circuit

NO-Intermittent failure, replace with a new ABS main fuse (15A/20A), and then check again.

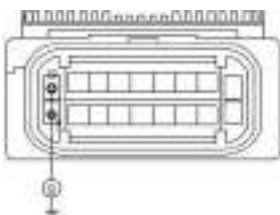

ANTI-LOCK BRAKE SYSTEM (ABS)

5. Open circuit inspection of power input line

Install the ABS main fuse (15A/20A). Turn on the ignition switch with the engine stop switch " ". Measure the voltage between the 18P (black) connector [1] terminal of the ABS regulator on the harness side and the ground.

Connection: 9 (+)-ground (-) / 18 (+)-ground (-)

Is there battery voltage?

YES -ABS modulation failure

NO-yellow line open / black and blue line open

ABS TROUBLESHOOTING**NOTICE:**

Unless otherwise specified, check with the ignition switch off. View all connector diagrams in the troubleshooting from the terminal side. Use a fully charged battery. Do not use a charger connected to the battery for diagnosis. When ABS adjustment is detected When there is a malfunction in the device assembly. Before replacing the wiring harness and connectors, please carefully check the wiring harness and connector connections. After troubleshooting, clear the DTC, and during the self-diagnosis before starting, test drive the vehicle to check whether the ABS indicator is working properly. In abnormal driving or situations, the ABS indicator light may flash. This is a temporary fault. Clear the DTC, and then test drive the motorcycle at a speed higher than 12km/h. Check whether the ABS indicator light is working properly

ANTI-LOCK BRAKE SYSTEM (ABS) ABS

Wheel speed sensor**Speed Sensor Air Gap Inspection**

Use a crane or equivalent to firmly support the motorcycle and lift the wheels off the ground. Slowly turn the wheels and measure the gap (air gap) between the sensor and the ring gear at multiple points. It must be within the specifications.

Standard: 0.2-1.2mm (0.02-0.05in)

The gap (air gap) cannot be adjusted. If it is not within the specification range, check whether each part is deformed, loose or damaged. Check whether the wheel speed sensor is damaged, and replace if necessary. Check whether the gear ring is deformed or damaged, and replace if necessary

- Front gear ring
- Rear gear

**REMOVAL/INSTALLATION****Front wheel speed sensor**

Remove the fuel tank guard plate-right. Remove the front wheel speed sensor 2P (blue) from the bracket, and disconnect the connector.

Disassemble the following parts:

- 2 wire clips[1]
- 1 line card[2]
- Reflector[3]
- Bolt[4]
- Front wheel speed sensor[5]

The installation sequence is opposite to the removal sequence.

 ANTI-LOCK BRAKE SYSTEM (ABS) ABS

NOTICE:

Thoroughly clean the sensor tip and sensor installation area (Brake clamp bracket), and ensure that no foreign objects are allowed. After installation, check the gap (0.2-1.2mm)

**Rear wheel speed sensor**

Remove the start relay switch. Remove the two bolts [1] and the rear pedal bracket [2] from the frame, and then fix them with a belt.



Remove the rear wheel speed sensor 2P (gray) connector [1] from the bracket and disconnect it, loosen the heat shield rubber [2] from the pull wire of the start relay switch. Loosen the wire clamp [3] and adjust it from Remove the band clamp [4] from the bracket of the sensor. Remove the sensor wire from the frame through the opening [5] in the rubber of the heat shield.



*When connecting,
cover the ends of
Brake hoses and pipes
to prevent
contamination*

ANTI-LOCK BRAKE SYSTEM (ABS) ABS

Remove the following:

- Rear wheel speed sensor[1]
- Bolt[2]

The installation sequence is opposite to the removal sequence.

NOTICE:

Thoroughly clean the sensor tip and sensor installation area (Brake clamp bracket) to ensure that no foreign objects are allowed. After installation, check the air gap



ABS MODULATOR

REMOVAL/INSTALLATION

After draining the Brake fluid in the Brake hydraulic system.

Disassemble the following parts:

- cushion
- Battery
- Adjustable rectifier
- Cushion bracket
- ABS modulator cover

Disconnect the 18P (black) connector of the ABS regulator. Remove the Brake tube lock bolt [2] and the sealing washer [3], and disconnect the Brake hose [1]. Loosen the pipe joint nut [4] to disconnect the metal oil pipe [5].

 ANTI-LOCK BRAKE SYSTEM (ABS) (ABS)

NOTICE: When connecting, cover the ends of Brake hoses and pipes to prevent contamination

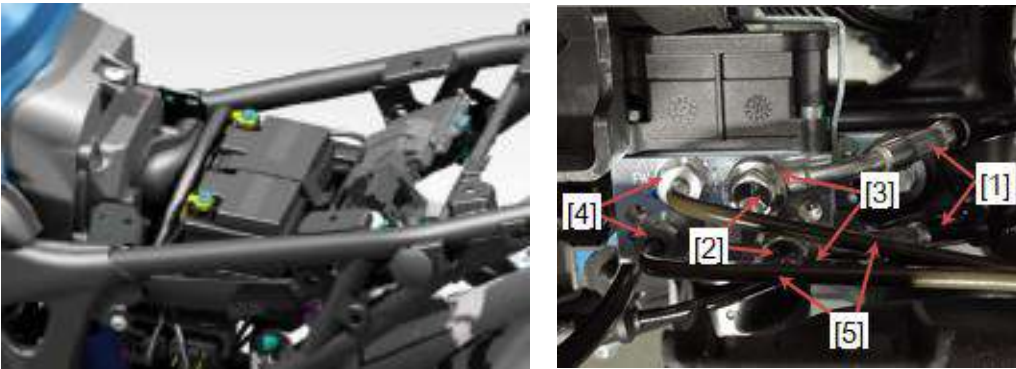

Remove the two mounting bolts [1] and the ABS adjuster [2] from the bracket

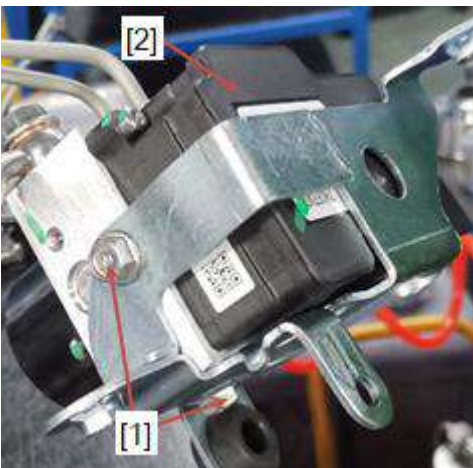

The installation sequence is opposite to the removal sequence.

Torque:

Metal tubing connector nut: 14N.m (1.4 kgf.m, 10 lbf.ft)

Brake hose oil bolt: 22N.m (2.2kgf.ft, 16 lbf.ft)

Brake hydraulic system before and after filling and draining

ABS braking matters needing attention

Impaired ABS function

Modifications, such as shortening or extending the damping stroke, using other wheels, other tire specifications, wrong tire pressure, other Brake friction pads, etc., may make ABS unable to continue to perform optimally. Only use the Brake system by the supplier. The best function of ABS can only be guaranteed when spare parts and tires are approved or recommended.

Brake recommendations for ABS systems

- The first principle of ABS Brake: Brake as if it is not equipped with ABS.
- When the brake lever is Brake, don't be too fast and violent. After the Brake piece is completely involved, increase the Brake pressure by a large amount.
- You can perceive the intervention of ABS through the slight vibration of the brake lever or the foot Brake lever and the short sound.
- Do not perform a complete Brake operation with files.
- Practice Brake regularly within the ABS control range. This allows you to take full advantage of the full potential of ANTI-LOCK BRAKE SYSTEM (ABS) in the event of a serious accident.

ANTI-LOCK BRAKE SYSTEM (ABS)

DTC	Failure Description
C0024	MCU_MU_CLK_Monitor_Failed 微控制器时钟检测错误
C0032	MCU_MC_ROM_Failed 微控制器ROM错误
C0033	MCU_MC_RAM_Failed 微控制器RAM错误
C0040	MCU RAM Stack Overflow Fault 微控制器RAM堆栈错误
C0041	MCU Hardware Reset 微控制器硬件复位
C0044	Solid State Relay_ Relay over current 固态继电器_过流
C0045	Solid State Relay_ Relay shorted (Stuck on) 固态继电器_继电器短路(卡死)
C0046	Solid State Relay_ shorted to ground 固态继电器_与地短接
C0051	Battery Voltage _Battery under-voltage 1 (7V < Voltage < 9V) 电池电压过低1, (大于7伏小于9伏)
C0052	Battery Voltage _Battery under-voltage 2 (Voltage <= 7V) 电池电压过低2, (小于等于7伏)
C0053	Battery Voltage _Battery over-voltage 电池电压过高
C0060	Brake Pedal Not Applied with Decel不踩刹车有减速度
C0061	Brake Pedal Always Applied Without Decel Fault 踩下刹车时没有减速度
C0062	Brake Diode Breakdown 刹车二极管击穿
C0070	Pump Motor control_ Bad connection or Pump supply open or low voltage 泵电机连接差或供电端开路或电压过低
C0071	Pump Motor control_ Pump ground open or Motor open 泵电机开路或地线开路
C0072	Pump Motor control_ Pump FET shorted 泵电机开关管短路
C0073	Pump Motor control_ Pump FET open 泵电机的开关管开路
C0074	Pump Motor control_ Pump over current 泵电机过流
C0075	Pump Motor control_ Pump motor blocked 泵电机堵转
C0080	Front_WSS_HSS_Short_To_Battery前轮轮速传感器高端与电源短接
C0081	Front_WSS_LSS_Short_To_Battery前轮轮速传感器低端与电源短接
C0082	Front_WSS_HSS_Short_To_Ground or WSS short circuited 前轮轮速传感器高端接地或短路
C0083	Front_WSS_LSS_Short_To_Ground or WSS open 前轮轮速传感器低端接地或开路
C0084	Front_WSS_Plausibility01前轮轮速传感器信号失真等级01
C0085	Front_WSS_Plausibility02前轮轮速传感器信号失真等级02
C0086	Front_WSS_Plausibility03前轮轮速传感器信号失真等级03

ANTI-LOCK BRAKE SYSTEM (ABS)

C0087	Front_WSS_Plausibility04前轮轮速传感器信号失真等级04
C0088	Front_WSS_Plausibility05前轮轮速传感器信号失真等级05
C0100	Rear_WSS_HSS_Short_To_Battery后轮轮速传感器高端与电源短接
C0101	Rear_WSS_LSS_Short_To_Battery后轮轮速传感器低端与电源短接
C0102	Rear_WSS_HSS_Short_To_Ground or WSS short circuited 后轮轮速传感器高端接地或短路
C0103	Rear_WSS_LSS_Short_To_Ground or WSS open 后轮轮速传感器低端接地或开路
C0104	Rear_WSS_Plausibility01 后轮轮速传感器信号失真等级01
C0105	Rear_WSS_Plausibility02后轮轮速传感器信号失真等级02
C0106	Rear_WSS_Plausibility03后轮轮速传感器信号失真等级03
C0107	Rear_WSS_Plausibility04后轮轮速传感器信号失真等级04
C0108	Rear_WSS_Plausibility05后轮轮速传感器信号失真等级05
C0120	Front_NO Coils Short to battery 前轮常开线圈接电源
C0121	Front_NO Coils Short to ground or Open solenoid 前轮常开线圈接地或开路
C0130	Front_NC Coils Short to battery 前轮常闭线圈接电源
C0131	Front_NC Coils Short to ground or Open solenoid 前轮常闭线圈接地或开路
C0160	Rear_NO Coils Short to battery 后轮常开线圈接电源
C0161	Rear_NO Coils Short to ground or Open solenoid后轮常开线圈接地或开路
C0170	Rear_NC Coils Short to battery后轮常闭线圈接电源
C0171	Rear_NC Coils Short to ground or Open solenoid后轮常闭线圈接地或开路
C0210	Warning Lamp output_Short to battery 报警灯输出与电源短路
C0213	Warning Lamp output_Short to ground or open报警灯输出与地短路或开路
C0230	Vehicle speed output_Short to ground 车速输出口与地短路
C0231	Vehicle speed output_Short to battery 车速输出口与电源短路

20.BATTERY/CHARGING SYSTEM

SERVICE INFORMATION -----	20-1	CHARGING SYSTEM INSPECTION-----	20-8
TROUBLESHOOTING -----	20-2	ALTERNATOR CHARGING COIL -----	20-9
SYSTEM LOCATION -----	20-5	REGULATOR/RECTIFIER -----	20-10
BATTERY -----	20-6		

SERVICE INFORMATION

GENERAL



- The battery gives off explosive gases; keep sparks, flames and cigarettes away. Provide adequate ventilation when charging.
- The battery contains sulfuric acid (electrolyte). Contact with skin or eyes may cause severe burns. Wear protective clothing and a face shield.
 - If electrolyte gets on your skin, flush with water.
 - If electrolyte gets in your eyes, flush with water for at least 15 minutes and call a physician immediately.
- Electrolyte is poisonous.

NOTICE:

Before disconnecting any electrical components, be sure to turn off the ignition switch. If you connect or disconnect the terminals or connectors when the ignition switch is on and current is present, some electrical components may be damaged. To extend the storage time, please remove Fully charge the battery and store it in a dry space in a cool place. For the battery stored in the motorcycle, charge it every 2 weeks, disconnect the battery negative cable from the battery terminal. After the maintenance-free battery reaches the end of its service life Must be replaced. If overcharged or undercharged, or discharged for a long time, the battery may be damaged. These conditions will shorten the "life" of the battery. Even under normal use, the performance of the battery will deteriorate in 2-3 years. Battery charging After that, the battery voltage may recover, but under heavy load, the battery voltage will drop rapidly and eventually disappear. Therefore, it is often suspected that there is a problem with the charging system. The overcharging of the battery is usually caused by the problem of the battery itself, which may be overcharging Symptoms. If one of the battery cells is short-circuited and the battery voltage does not increase, the regulator/rectifier provides too much voltage to the battery. In this case, the electrolyte level drops quickly. Before troubleshooting the charging system, Please check whether the battery is used and maintained correctly. Check whether the battery is often under heavy load, such as headlights and taillights are on for a long time without riding a motorcycle. When the car is not in use, the battery will automatically discharge. Therefore, correct every 2 weeks Charge the battery once to prevent sulfation. When checking the charging system, be sure to follow the steps in the troubleshooting flowchart.

·Maintenance of Magneto

Battery charging

Turn on/off the power on the charger instead of charging the battery at the battery terminal. Do not exceed the charging current and time specified on the battery

BATTERY/CHARGING SYSTEM

Using excessive current or prolonging the charging time may damage the battery. Fast charging can only be done in an emergency; slow charging is best

Battery test

For detailed information about battery testing, please refer to the instructions in the recommended battery tester operation manual. The recommended battery tester imposes a "load" on the battery in order to measure the actual battery condition.

Recommended battery tester: Micro 404XL (U.S. only), BM-210 or equivalent

Troubleshooting**Damaged or weak battery****1. Battery test**

Take out the battery and use the recommended battery tester to check the battery condition.

Recommended battery tester: Micro 404XL (US only), BM-210 or equivalent

Is the battery intact?

YSE-Go to step 2

NO-battery failure

2. Leakage test

Install the battery. Use a digital multimeter to check the battery current leakage.

Is the current leakage lower than 0.3 mA?

YES-Go to step 4

NO-go to step 3

NO-Harness short circuit ignition switch failure

3. Current Leakage Test with Regulator/rectifier Connector Disconnected

Disconnect the regulator/rectifier 3P (Black) connector.

Recheck the battery current leakage.

Is the current leakage below 0.3 mA?

YES-Regulator out of order

NO -Wiring harness short circuit ignition switch fault

4. Charging Voltage Inspection

Use a digital multimeter to measure and record the battery voltage and start the engine.

The measured charging voltage is compared with the following calculation results.

STANDARD:

Measured BV < Measured CV < 15.5 V

•BV = Battery Voltage •CV = Charging Voltage

Do the battery and charging voltages satisfy the calculation?

YES- Faulty battery

NO -GO TO STEP 5

5. Alternator Charging Coil Inspection

Check the magneto charging coil

Is the alternator charging coil resistance within 0.1 - 1.0 Ω (20° C/68° F)?

YES-GO TO STEP 6.

NO -Faulty charging coil

6. Regulator/rectifier Wire Harness Inspection

Check the regulator/rectifier wire harness.

Are the results of checked voltage and continuity correct?

YES- Faulty regulator/rectifier.

NO -•Open circuit in related wire

- Loose or poor contacts of related terminal
- Shorted wire harness.

SYSTEM LOCATION



BATTERY

REGULATOR/
RECTIFIER

BATTERY

REMOVAL/INSTALLATION

Disassemble the following parts:

Front seat. Turn off the ignition switch. First disconnect the negative (-) cable [1], and then disconnect the positive (+) cable [2] by removing the terminal bolt. Remove the rubber band [3] and the battery [4]. The installation sequence is opposite to the removal sequence

NOTICE:

Connect the positive (+) cable first, then connect the negative (-) cable, make sure to install the cable clamp [5] on the battery (-) cable to the battery cover. Digital clock setting program

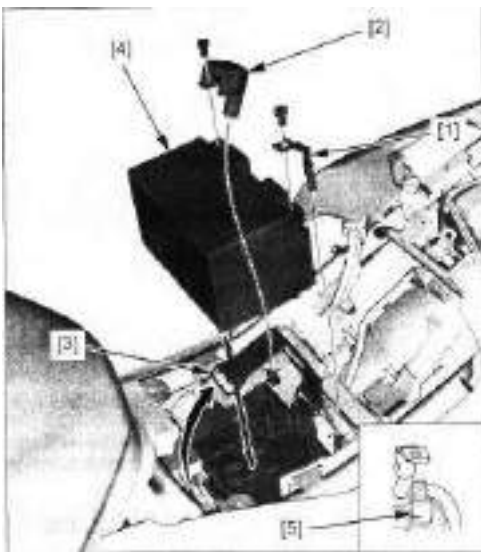

Voltage detection

Voltage check

Disassemble the following parts:

For the front seats, use a digital multimeter to measure the battery voltage

Voltage (20°C/68° F):

Fully charged: 13.0-13.2V

Need to charge: less than 12.75V

BATTERY/CHARGING SYSTEM

NOTICE:

When measuring the battery voltage after charging, it should be kept for at least 30 minutes, otherwise accurate results cannot be obtained due to the fluctuation of the battery voltage after charging.

BATTERY TESTING

To remove the battery, refer to the instructions applicable to the battery test equipment available to you.



CHARGING SYSTEM INSPECTION**CURRENT LEAKAGE TEST**

Remove the following:

-Front seats

Turn off the ignition switch, remove the terminal bolts and disconnect the negative (-) cable from the battery [1]. Connect the ammeter (+) probe to the negative (-) cable, and connect the ammeter (-) probe to the battery Negative terminal [2]. Turn off the ignition switch and check for current leakage.

NOTICE:

When using the tester to measure current, set it to a high range, and then reduce the range to an appropriate level; currents higher than the selected range may burn the fuse in the tester. When measuring current, do not turn on the ignition switch. A sudden current surge may blow the fuse in the tester.

Specified current leakage: 0.3 mA maximum, if the current leakage exceeds the specified value, it may be a short circuit. Locate the short circuit by disconnecting one by one and measuring the current.

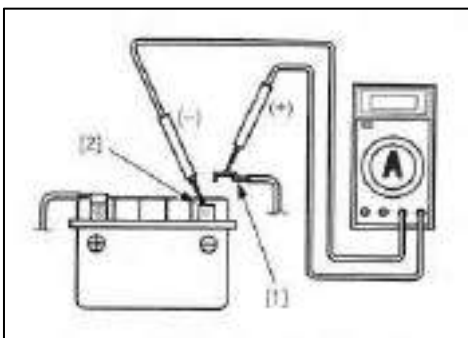
**CHARGING VOLTAGE INSPECTION****NOTICE:**

Before performing this test, please make sure that the battery is in good condition. Do not disconnect any cables in the battery or charging system without turning off the ignition switch; failure to follow this precaution may damage the detector or electrical components; warm up the engine To normal operating temperature; stop the engine.

BATTERY/CHARGING SYSTEM

Remove the following

-Front seats

Connect the multimeter between the positive (+) terminal of the battery and the negative (-) terminal of the battery. Turn on the headlights and restart the engine; when the engine is running at 5000rpm, measure the voltage on the multimeter.

standard:

Measure BV < Measure CV < 15.5 V

BV = battery voltage

CV = Charging voltage

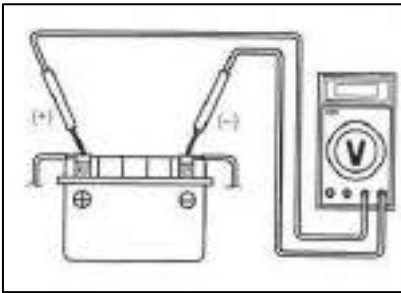

ALTERNATOR CHARGING COIL

INSPECTION

Remove the left side cover. Disconnect the magneto 3P (gray) connector from the regulator/rectifier [1]. Check whether the contacts of the connector are loose or whether the terminals are corroded. Measure one of the yellow terminals of the 3P (gray) connector on the magneto side Resistance between.

Standard: 0.1-1.0Ω (20°C/68°F)

Check the continuity between each terminal of the 3P (gray) connector on the magneto side and the ground; there should be no continuity. If the resistance does not meet the specifications, or if there is continuity between any wire and the ground, replace it Magneto stator in order to replace the magneto stator.



BATTERY/CHARGING SYSTEM

REGULATOR/RECTIFIER

WIRE HARNESS INSPECTION

Remove the left side cover and disconnect the 3P (black) connector of the regulator rectifier [1]. Check whether the contacts of the connector are loose or whether the terminals are corroded. Check the following items on the 3P (black) connector on the harness side.

Battery cable:

Measure the voltage between the red wire (+) and ground (-). There should always be battery voltage.

Ground wire:

Check the continuity between the green wire terminal and ground. Continuity should be maintained at all times.

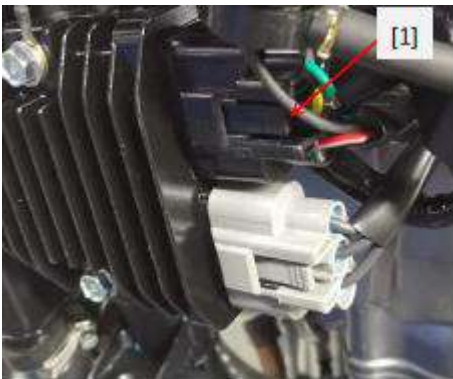

REMOVAL/INSTALLATION

Remove the fuel tank guard plate-left

Remove the 2 bolts [1] and the regulator/rectifier [2] from the frame, disconnect the regulator/rectifier 3P (black) [3] and the magneto 3P (gray) [4] connector, and remove the regulator / Rectifier. The installation sequence is opposite to the removal sequence.

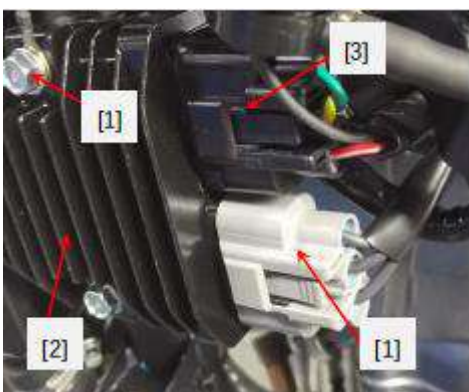

21.LIGHTS/METERS/SWITCHES

SERVICE INFORMATION-----	21-1	FUEL GAUGE/FUEL LEVEL SENSOR -----	21-12
SYSTEM LOCATION -----	21-2	IGNITION SWITCH-----	21-13
HEADLIGHT-----	21-3	HANDLEBAR SWITCH-----	21-14
TURN SIGNAL LIGHT-----	21-3	BRAKE LIGHT SWITCH -----	21-15
BRAKE/TAILLIGHT-----	21-4	CLUTCH SWITCH -----	21-15
LICENSE LIGHT-----	21-5	NEUTRAL SWITCH -----	21-16
COMBINATION METER -----	21-5	SIDESTANDSIDE SWITCH-----	21-17
SPEEDOMETER -----	21-8	HORN -----	21-19
TACHOMETER -----	21-8	TURN SIGNAL/HAZARD RELAY -----	21-20
HIGH COOLANT TEMPERATURE INDICATOR/ECT SENSOR -----			21-8
ECT SENSOR -----	21-9	RELAY -----	21-21
ENGINE OIL PRESSURE INDICATOR LIGHT -----			21-9
		ABS FUSE -----	21-23
		WIRING DIAGRAM -----	21-25

LIGHTS/METERS/SWITCHES

SERVICE INFORMATION**GENERAL**

NOTICE:

When replacing LED headlights, please pay attention to the following matters. Be sure to install the dust cover after replacing the headlights. Before performing any checks that require the correct battery voltage, check the battery condition. The continuity test can be carried out using the switch installed on the motorcycle. Use the electric heating element to heat the heating element and the wear amount does not exceed the coolant, so that the engine coolant temperature sensor can be checked. Keep flammable materials away from insulating gloves and eye protection. The following color codes are used in this section.

Bl=black G=green Lg=light green R=red Y=yellow

Br=brown Gr=grey O=orange V=purple

Bu=blue Lb=light blue P=pink W=white

LIGHTS/METERS/SWITCHES

SYSTEM LOCATION



HEADLIGHT**HEADLIGHT REMOVAL/INSTALLATION**

Remove the following:

- Bolt[1]
- Headlight shell[2]
- Front headlight rear panel decoration cover [3], wires (from the front cover)
- Front headlight rear panel [4]
- Headlight bracket[5]

The installation sequence is opposite to the removal sequence.

Torque:

Headlamp mounting bolts: 8N.m (0.8kg.m, 5.9 lbf.ft)

**Turn signal light****FRONT TURN SIGNAL LIGHT****REMOVAL/INSTALLATION**

Remove the dashboard and disconnect the turn signal connector (left; orange/right; light blue).

Remove the following:

- Nut

The installation sequence is opposite to the removal sequence.

Torque:

Install nuts for front steering lights: 10 N.m (1.0 kgf.m, 7 lbf.ft)



REAR STEERING LIGHTS REMOVAL/INSTALLATION

Remove the following:

- Rear mudguard interior trim panel
- Disconnect the turn signal connector
- Rear turn signal lamp assembly (left; orange/right; light blue) -

Torque:

Rear steering light mounting nut: 10 N.m (1.0 kgf.m, 7 lbf.ft)



BRAKE/TAIL LIGHT

BRAKE/TAIL LIGHT REMOVAL/INSTALLATION

Remove the seat cushion, turn signal, tail cover

- Remove the 2 cross recessed pan head screws, flat washers and flange bushings at position [1]
- Brake/tail lamp assembly [4] (disconnect the wiring harness connector first)

The installation sequence is opposite to the removal sequence.



License plate lamp

LICENSE PLATE LAMP REMOVAL/INSTALLATION

Disassemble the rear section of the rear fender.

Removal/installation of licence lights:

- Two Phillips round head screws [1]
- License plate lamp assembly[2]
- The installation sequence is opposite to the removal sequence.

Firmly support the front cover assembly to avoid damaging the wiring harness

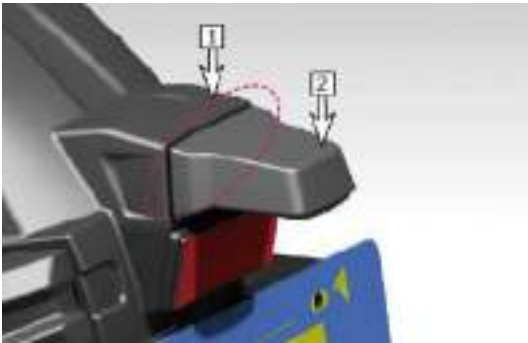

Combination instrument

Initial operation check

When the ignition switch and the engine stop switch "⏻" are turned on together, the instrument cluster will display the entire digital display, and the tachometer section [1] will decrease from full scale to zero.

NOTICE:

If the fault indicator [2] does not go off, please refer to the fault diagnosis and troubleshooting indicator circuit; if the digital display does not work at all, check the power/ground wire of the combination meter; if the power and ground wires are normal replace the combination meter



Power/ground check

NOTICE:

If the power or grounding circuit is abnormal, after the repair is completed, check and clear the diagnosis code. Remove the instrument panel, disconnect the 24 (gray) connector of the combination meter. Remove the instrument sun visor. Disconnect the 24P (gray) connector of the combination meter

[1]

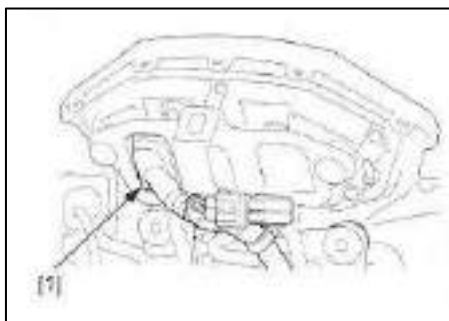

Power input line

Measure the voltage connection between the 24P (gray) connector [1] terminal of the combination meter and the ground: black (+)-ground (-) when the ignition switch is turned on, there should be battery voltage. If there is no battery voltage, please check the following: Fuse Black between box 1 and the instrument cluster

- There is an open circuit in the wire
- Secondary fuse (20A)

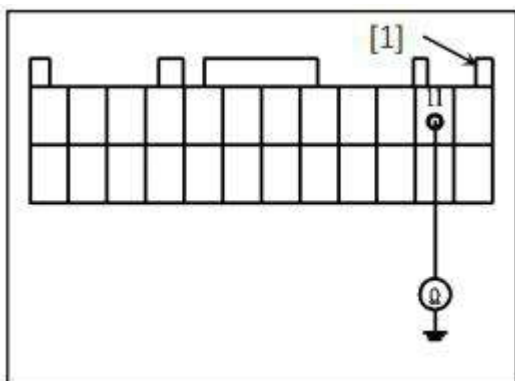

GROUND LINE

Check the continuity between the 24P (gray) connector [1] terminal of the combination meter and the ground. Connection: green-the ground should always maintain continuity. If there is no continuity, check whether the green wire is open

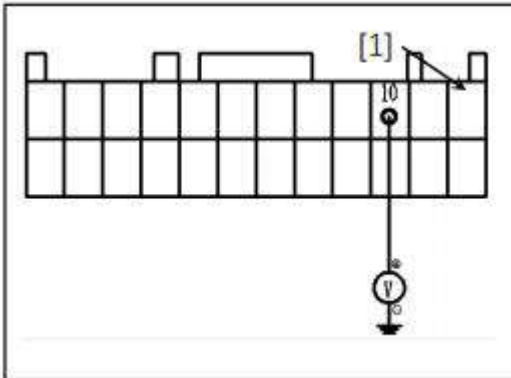

REMOVAL/INSTALLATION

Disassemble the instrument case. Remove the two M6 screws [1] and the combined instrument assembly [2] from the instrument case. The installation sequence is opposite to the removal sequence

Torque:

Assembly meter mounting screw: 7.0N.m (0.7kgf.m, 5.2lb.ft)



Disassemble the headlight. Disconnect the connector of the combined instrument. Remove the 4 M6 bolts [1], turn the bushing [2], and the Pozier-shaped rubber ring [3] from the headlight bracket. The installation sequence is opposite to the removal sequence.

NOTICE:

When connecting the connector, correctly install the connector sheath into the groove of the combination meter

Speedometer

System check

If the speedometer does not work, check the following.

- Initial operation of the instrument cluster
- Line continuity: instrument-sensor; check VS sensor system

If the above items are normal, replace the combination meter

Tachometer

System check

If the tachometer does not work, check the following:

- Initial operation of the instrument cluster
- Line continuity: instrument-ECU
- Crankshaft Position Sensor (CKP)

If the above items are normal, replace the combination meter

Coolant temperature indicator/ECT sensor

System check

NOTICE:

If the coolant temperature indicator light and water temperature indicator do not work at all, please refer to the combination meter, initial operation check

If the coolant temperature indicator is not working properly, please check the following items:

- Line continuity: sensor-instrument
- ECT sensor

If the above items are normal, replace the combination meter

ECT sensor inspection

Remove the ECT sensor. Hang the ECT sensor [1] in a measuring cup of coolant (1:1 mixture of antifreeze and distilled water) on the heating element, and measure the resistance between the sensor terminals when the coolant is heated. Soak the ECT sensor in Keep the temperature constant for 3 minutes before the test. Sudden changes in temperature will cause incorrect readings. Do not let the thermometer [2] or the ECT sensor touch the measuring cup.

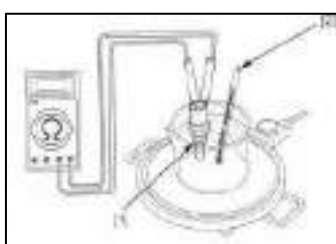

TEMPERATURE	50°C	107°C
RESISTANCE	2.31-2.45KΩ	0.314-0.316KΩ

At any temperature listed, if the ECT sensor exceeds the specification by more than 10%, replace the ECT sensor; install an engine coolant temperature sensor.

Engine oil pressure warning indicator

System inspection

When the system is normal, when the ignition switch is turned on, the engine oil pressure indicator light [1] lights up, the engine stop switch is turned on, and then goes out when the engine starts.

NOTICE:

If the oil pressure indicator does not work at all, please refer to the initial operation check of the combination instrument. If the engine oil pressure indicator lights up for about 2 seconds and goes out when the ignition switch is turned on, check whether the engine oil pressure switch circuit is open. If the engine is started, the engine oil pressure indicator light is always on, the engine should be stopped immediately. The engine oil pressure indicator light remains on, and others indicate normal operation;

Check the following:

- Engine oil level
- EOP short circuit switch circuit
- Engine oil pressure

If the above items are normal, replace the combination meter.



EOP switch wire inspection

Turn off the ignition switch and disconnect the EOP switch wire.

Open circuit check

Check the continuity between the terminal [1] and ground. There should be continuity.

- If there is no continuity, the EOP switch wires are red and black open.
- If there is continuity, replace the EOP switch.

Short circuit check

Disconnect the wire terminal and the EOP switch, and check the continuity between the wire terminal and the ground in the same way as above. There should be no continuity.

- If there is continuity, the EOP switch wires (red and black) are short-circuited.
- If there is no continuity, replace the EOP switch.

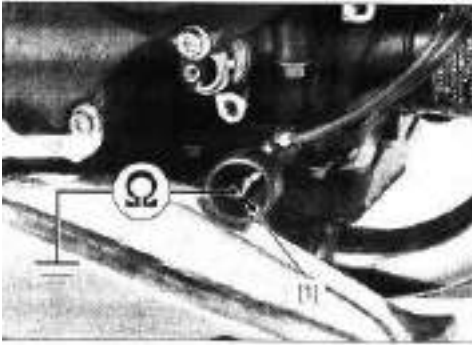

EOP SWITCH REMOVAL/INSTALLATION

Remove the lower cover.

Place the motorcycle on a horizontal surface and make it stand on its side. Loosen the rubber cover [1] from the EOP switch [2]. Remove the terminal screw [3] and disconnect the switch wire [4]. Remove the EOP switch. Installation sequence The order of disassembly is reversed.

NOTICE:

Before installing the EOP switch, please thoroughly clean the threads in the crankcase with degreaser. Apply sealant on the threads of the engine oil pressure switch. Do not apply the sensor tip in the area shown in the figure.

Torque:

EOP switch: 12 N.m (1.2 kgf.m, 9 lbf.ft)

EOP switch terminal screw: 1.0 N.m (0.1 kgf.m, 0.7 lbf.ft)

Check the engine oil level

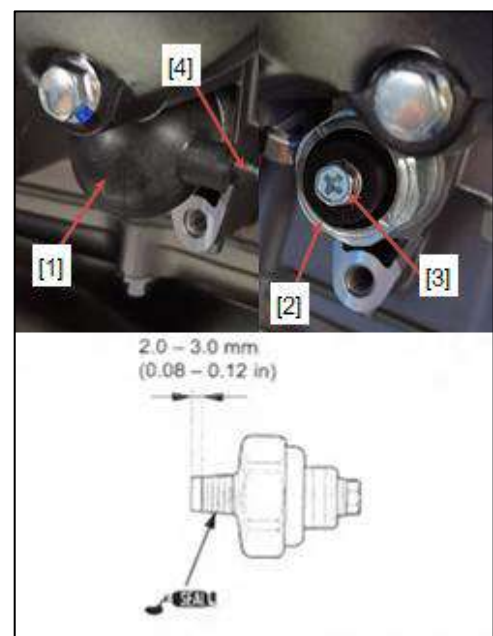

FUEL GAUGE/FUEL LEVEL SENSOR

FUEL GAUGE INSPECTION

When a circuit failure occurs, the combination meter displays the flow mode in the fuel meter; if indicated, check whether the yellow, white and green wires between the combination meter and the fuel pump unit are open or short. If the yellow, white/green wires are normal, check the fuel level sensor. If the fuel oil level sensor is normal, replace the combination meter.

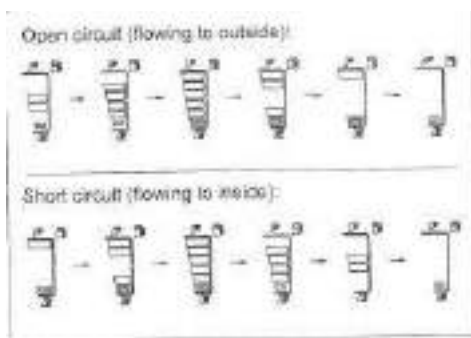

FUEL LEVEL SENSOR INSPECTION

Disassemble the fuel pump unit. Measure the resistance connection between the 4P (white) connector terminals of the fuel pump unit: yellow-white-green

FLOAT POSITION	Up (Full)	Down (Empty)
RESISTANCE (20° C/68° F)	9-13Ω	90-100Ω

If the resistance does not meet the specifications, replace the fuel pump unit as an assembly.

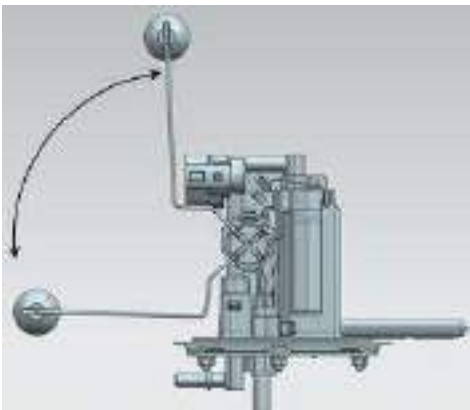

IGNITION SWITCH

INSPECTION

Remove the left middle front cover. Remove EVAP. Remove the ignition switch 2P (green) connector from the bracket [1]. Loosen the connector sheath [2] and disconnect the connector. Check each switch according to the continuity table Continuity between the 2P (green) connector terminals on the switch side of the position.

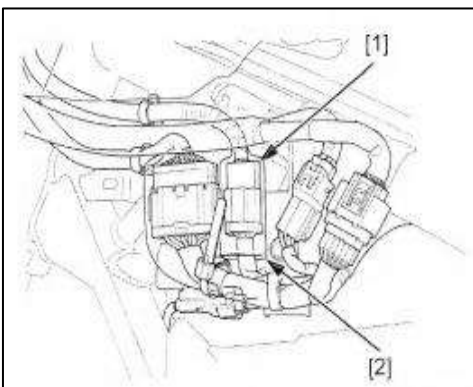

REMOVAL/INSTALLATION

Remove the following:

- Fuel tank guard plate[1].
- Fuel tank[2]
- 2 M8 bolts[3]

NOTICE:

When removing the ignition switch mounting bolts, use a screwdriver or equivalent tool. The installation sequence is opposite to the removal sequence

NOTICE:

Replace with new switch bolt

Torque:

Ignition switch mounting bolts:
22 N.m (2.2 Kgf.m, 16 lbf.ft)



Handle switch

Left handlebar

Remove the fuel tank guard plate-left

Disassemble EVAP.

Remove the cable tie [1].

Remove the left handle switch 9P (white) connector [2] from the strut. Loosen the connector sheath [3] and disconnect the connector. According to the continuity table, check one of the switch side connector terminals for each switch position Continuity

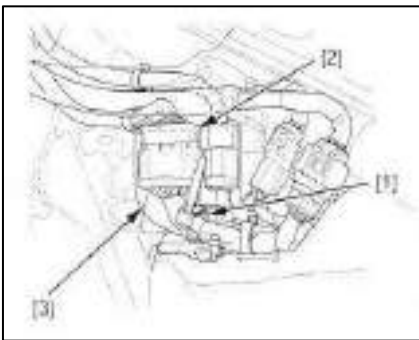

Right handlebar

Right handle switch, remove the right middle cover. Remove the bolt [1] and relay box support rod [2] from the frame. Loosen the fixing clip, and remove the right handle switch 6P (white) connector from the relay box bracket [3]. Loosen the connector sheath [4] and disconnect the connector. According to the continuity table, check the continuity between the 6P connector terminals on the switch side of each switch position.

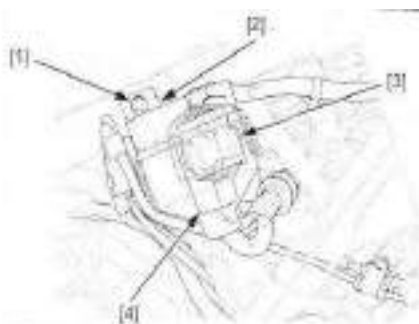

BRAKE LIGHT SWITCH

FRONT

Disconnect the brake light switch connectors [1] and check for continuity between the switch terminals. There should be continuity with the brake lever squeezed, and no continuity when the brake lever is released.



REAR

Remove the right side cover, disconnect the rear brake light switch 2P (white) connector [1]. Check the continuity between the switch side connector terminals. When you step on the brake pedal, keep the continuity and release the brake. Continuity should not be maintained when pedaling.

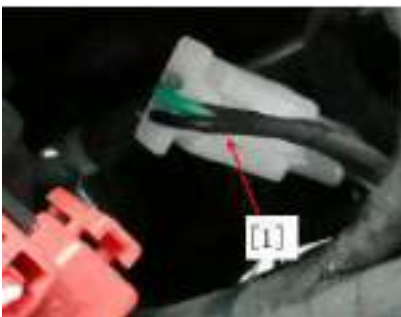

CLUTCH SWITCH

Remove the connector sheath [1] from the bracket sleeve [1] disconnect the clutch switch connector [2]



and check the continuity between the switch terminals. When the clutch lever is squeezed, there should be continuity. When the clutch lever is released, there should be no continuity.

NEUTRAL SWITCH

INSPECTION

Disconnect the neutral switch wire. Check the continuity between the switch terminal and the engine ground. The transmission should be continuous when in neutral, and should not be continuous except for neutral when the transmission is engaged.



REMOVAL/INSTALLATION

Remove the following:

- Clamping bolt[1]
- Shift arm[2]
- End cover[3]
- Terminal nut[4]
- Terminals [5]
- Neutral switch[6]
- Sealing washer[7]

The installation sequence is opposite to the removal sequence. -

NOTICE:

Replace with a new sealing washer. When tightening the terminal nut, the wire terminal is vertically upward. Align the cut on the shift arm with the punch mark on the spindle.

Torque:

Neutral switch: 12 N.m (1.2 kgf.m, 9 lbf.ft)

Terminal nut: 1.0 N.m (0.1 kgf.m, 0.7lbf.ft)

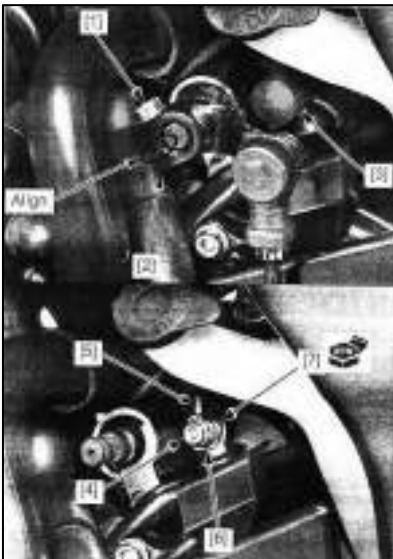
**SIDESTAND SWITCH****INSPECTION**

Remove the fuel tank guard plate-left, disconnect the side switch 3P (white) connector [1]. Check the continuity between the switch side connector terminals. There should be no continuity when the side stand is retracted; the side stand remains conductive when the side stand is lowered Generality.

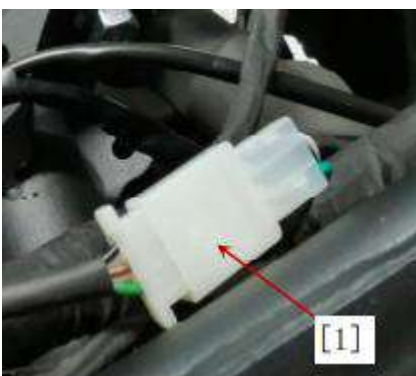

REMOVAL/INSTALLATION

Remove the following:

- Tank guard - left

Disconnect the side support switch connector and remove the side stand switch wire [1] from the frame. Remove the bolt [2] and side stand switch [3]. The installation sequence is reverse to the removal sequence.

NOTICE:

Align the switch pin with the hole on the side pedal, and align the switch slot with the return spring pin. Replace the switch bolt with a new one.

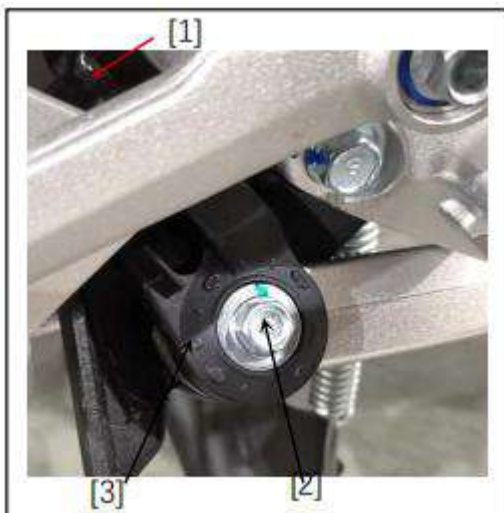

HORN

INSPECTION

Disconnect the connector from the horn [1]. (light green) When the ignition switch is turned on, and the negative (-) of the battery is connected to the horn terminal, the sound from the horn is normal.

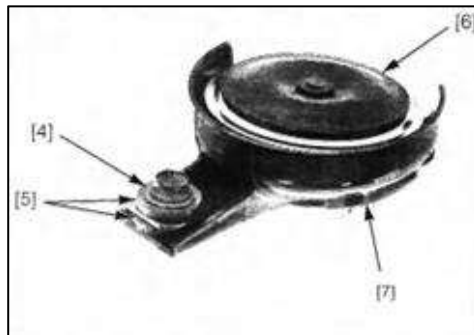

REMOVAL/INSTALLATION

Disconnect the connector [1]. Loosen the mounting bolt [2] and remove the horn assembly [3].

Disassemble the following parts:

- Mounting bolts
- Bolt ring[4]
- Two rubber bearings [5]
- Speaker[6]
- Heat shield[7]

Install in the reverse order of removal.

NOTICE:

When tightening the mounting bolts, align the fixed end of the horn with the boss of the frame.

Turn signal/hazard signal relay

NOTICE:

The hazard flashlight system can be operated with the ignition switch turned on. When the hazard flashlight system is working, the ignition switch is turned off; the system continues to run

REMOVAL/INSTALLATION

Turn off the ignition switch, lift the fuel tank and support it, remove the turn signal/hazard light relay [1]. Loosen the dust cover [2] and disconnect the 2P (black) connector [3] to remove the turn signal/hazard relay ; The installation sequence is opposite to the removal sequence.

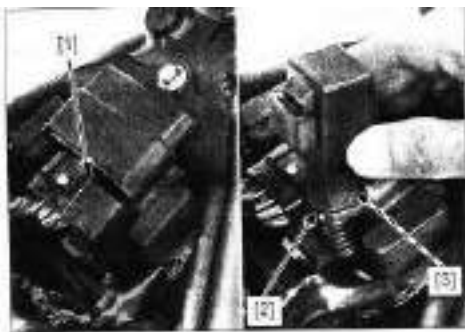

Relay circuit inspection

Remove the turn signal/hazard relay. Check the following items on the harness side (black) connector.

1. Check for open circuit of battery power cord

Turn on the ignition switch and measure the voltage between the (black) connector terminal and ground.

Connection: black (+)-ground (-)

Is there battery voltage?

YES-Go to step 2

NO-black wire open circuit

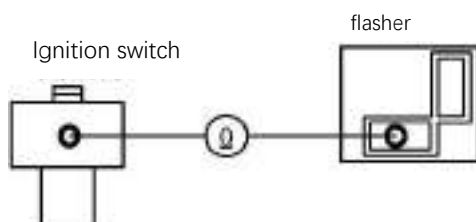

2. Turn signal/hazard switch circuit open circuit inspection

Use a jumper wire to connect the 2P (black) connector [1] terminal and the left combination switch to operate the turn signal switch or press the hazard warning switch.

Is the turn signal light on?

YES-the gray wire is open

NO-- Turn signal switch or hazard warning switch malfunction

The turn signal lamp or hazard warning lamp circuit is faulty.

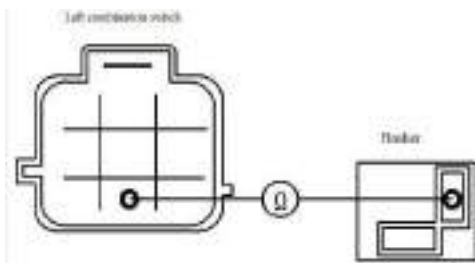

RELAY

RELAY REMOVAL/INSTALLATION

Remove the fuel tank guard plate-right. Turn off the ignition switch, remove the relay box cover and pull up, and remove the following parts.

- Main relay
- Fan control relay
- Oil Pump Relay

The installation sequence is opposite to the removal sequence



RELAY INSPECTION**NOTICE:**

All relays in the relay box are the same parts. The relay function can be checked by temporarily swapping with known good relays (except the main relay). Remove the relay as shown in the figure, and connect the ohmmeter and 12V battery to the headlight relay. The continuity should be maintained only when the 12 V battery is connected.

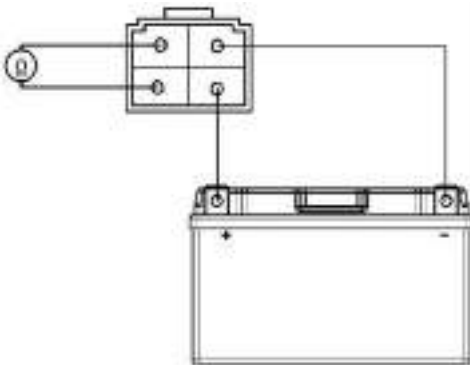
**HEADLAMP RELAY****CIRCUIT INSPECTION**

Relay inspection. Remove fuel pump relay. Relay switch coil power input wire.

Measure the voltage between the relay terminal (switching power input wire) of the harness side relay box and ground.

连接: B (+) - 接地 (-)

Connection: B (+)-ground (-)

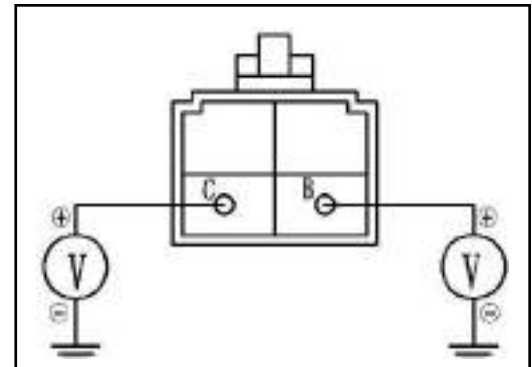

There should always be battery voltage. If there is no voltage, check the following:

The red/white wire between the relay box and the fuse box is open

Measure the voltage between the relay terminal (coil power input wire) of the harness side relay box [1] and ground.

Connection: C (+)-ground (-)

When the ignition switch is turned on with the engine stop switch "", there should be battery voltage.

If there is no voltage; check the following:

The black and white wire in the relay box between the main fan and the fuel fan control relay is open.

The main relay and its circuit are open.

SIGNAL LINE

Disconnect the engine control module 33P (black) connector. Check the continuity between the relay box and the wiring harness side ECU 48P (black) connector terminal

There should be continuity. If the continuity is good, check whether the gray wire between the relay box and the ECU is open. Check the continuity between the fuel pump relay terminal of the relay box [1] and the ground

Connection: D-ground

There should be no continuity. If the continuity is good, check whether the gray-white wire between the relay box and the ECU is short-circuited. If all the above checks are normal, check whether the gray-red (A) wire between the relay box and the fan motor. Open circuit.

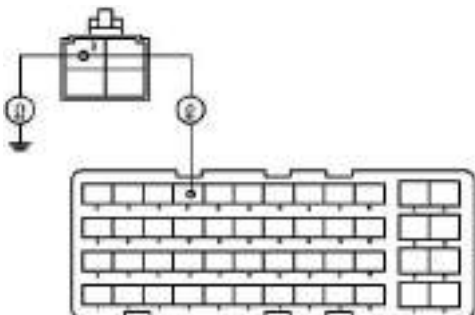
**ABS FUSE****INSPECTION**

Remove the fuel tank guard plate-right

Turn off the ignition switch. Remove the relay box cover. Remove the ABS fuse.



LIGHTS/METERS/SWITCHES

Check the continuity between the fuse terminals. When there is continuity, a small resistance value will be recorded. If there is continuity in the direction indicated by the arrow, the fuse is normal.

